

Lincoln Airport



Airport Master Plan

**FINAL
AIRPORT MASTER PLAN**

for

**LINCOLN AIRPORT
Lincoln, Nebraska**

Prepared for the

LINCOLN AIRPORT AUTHORITY

by

Coffman Associates, Inc.

In Association With

HWS Consulting Group, Inc.

August 2007

**Approved by the
Lincoln Airport Authority Board of Directors
July 26, 2007**

Lincoln Airport

TABLE OF CONTENTS

CONTENTS

LINCOLN AIRPORT Lincoln, Nebraska

Airport Master Plan

INTRODUCTION

| | |
|---------------------------------------|-----|
| MASTER PLAN OBJECTIVES..... | ii |
| MASTER PLAN ELEMENTS AND PROCESS..... | iii |
| COORDINATION | iv |

Chapter One INVENTORY

| | |
|--------------------------------------|------|
| REGIONAL SETTING..... | 1-2 |
| Location | 1-2 |
| Regional Transportation Network..... | 1-2 |
| Climate | 1-2 |
| AIRPORT HISTORY..... | 1-3 |
| Recent Capital Improvements | 1-4 |
| Airport Administration | 1-6 |
| THE AIRPORT'S SYSTEM ROLE | 1-6 |
| AVIATION ACTIVITY..... | 1-8 |
| Aircraft Operations | 1-8 |
| Passenger Activity..... | 1-9 |
| Cargo Activity..... | 1-10 |
| AIRFIELD FACILITIES..... | 1-11 |
| Runways | 1-11 |
| Taxiways..... | 1-13 |
| Hold Aprons..... | 1-14 |
| Pavement Markings..... | 1-14 |

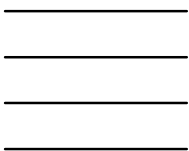

Chapter One (Continued)

| | |
|--|------|
| Airfield Lighting..... | 1-14 |
| Weather and Communication Aids..... | 1-16 |
| AREA AIRSPACE AND AIR TRAFFIC CONTROL | 1-17 |
| Airspace Structure | 1-17 |
| Special Use Airspace..... | 1-19 |
| Airspace Control..... | 1-20 |
| Navigational Aids..... | 1-20 |
| Instrument Approach Procedure | 1-21 |
| Airport Traffic Pattern..... | 1-23 |
| Regional Airports | 1-24 |
| LANDSIDE FACILITIES | 1-25 |
| Passenger Terminal Building | 1-25 |
| Automobile Parking | 1-26 |
| Terminal Aircraft Apron..... | 1-26 |
| Air Cargo Facilities | 1-27 |
| Fixed Base Operator (FBO) and Specialty Operators | 1-27 |
| General Aviation Hangars..... | 1-28 |
| Support Facilities | 1-28 |
| Other Facilities..... | 1-30 |
| Utilities..... | 1-31 |
| General Access to Lincoln Airport – Surrounding Roads..... | 1-33 |
| Competitive Modes..... | 1-33 |
| SOCIOECONOMIC PROFILE..... | 1-33 |
| Population..... | 1-34 |
| Employment | 1-34 |
| Income..... | 1-35 |
| ENVIRONMENTAL INVENTORY..... | 1-36 |
| DOCUMENT SOURCES | 1-38 |

Chapter Two FORECASTS

| | |
|------------------------------------|------|
| NATIONAL AVIATION TRENDS | 2-2 |
| Commercial Passenger Airlines..... | 2-3 |
| Air Cargo | 2-5 |
| General Aviation | 2-6 |
| SERVICE AREA | 2-11 |
| Commercial Service..... | 2-12 |
| General Aviation | 2-13 |
| SOCIOECONOMIC FORECASTS | 2-13 |
| Population..... | 2-13 |
| Employment | 2-14 |

Chapter Two (Continued)

| | |
|--|------|
| Per Capita Personal Income (PCPI) | 2-14 |
| FORECASTING APPROACH | 2-15 |
| COMMERCIAL SERVICE | 2-16 |
| Commercial Service History | 2-17 |
| Historic Passenger Enplanements | 2-18 |
| Factors Affecting Enplanement Levels | 2-21 |
| Enplanement Forecast | 2-22 |
| Enplanement Forecast Summary | 2-28 |
| Airline Fleet Mix and Operations | 2-31 |
| AIR CARGO | 2-34 |
| GENERAL AVIATION FORECASTS | 2-35 |
| Based Aircraft | 2-36 |
| General Aviation Operations | 2-40 |
| OTHER AIR TAXI | 2-43 |
| MILITARY ACTIVITY | 2-44 |
| ANNUAL INSTRUMENT APPROACHES | 2-45 |
| SUMMARY | 2-45 |

Chapter Three

FACILITY REQUIREMENTS

| | |
|---|------|
| PLANNING HORIZONS | 3-1 |
| PEAKING CHARACTERISTICS | 3-3 |
| Airline Peak Periods | 3-3 |
| Itinerant General Aviation/Air Taxi Peaks | 3-4 |
| Total Operations Peak Periods | 3-5 |
| AIRFIELD CAPACITY | 3-5 |
| Calculation of Annual Service Volume | 3-8 |
| CRITICAL AIRCRAFT | 3-10 |
| AIRFIELD REQUIREMENTS | 3-12 |
| Runway Configuration | 3-12 |
| Runway Dimensional Requirements | 3-13 |
| Airfield "Hot Spots" | 3-18 |
| Safety Area Design Standards | 3-19 |
| Instrument and Visual Navigational Aids | 3-22 |
| Airfield Lighting, Marking, and Signage | 3-23 |
| Weather and Communication Information | 3-24 |
| PASSENGER TERMINAL COMPLEX REQUIREMENTS | 3-25 |
| Ticketing and Airline Operations | 3-25 |
| Departure Gates and Holdrooms | 3-26 |
| Baggage Claim | 3-26 |
| Terminal Services | 3-27 |

Chapter Three (Continued)

| | |
|--|------|
| Public-Use Area and Security Screening | 3-27 |
| Building Support and Administration | 3-28 |
| Terminal Requirements Summary..... | 3-29 |
| GROUND ACCESS REQUIREMENTS..... | 3-29 |
| Terminal Access Roadway | 3-29 |
| Terminal Curb Frontage..... | 3-30 |
| Vehicle Parking..... | 3-30 |
| GENERAL AVIATION FACILITIES..... | 3-31 |
| Hangars | 3-31 |
| Aircraft Parking Apron | 3-32 |
| General Aviation Terminal Facilities..... | 3-33 |
| AIR CARGO | 3-34 |
| SUPPORT FACILITIES | 3-35 |
| Automobile Parking | 3-35 |
| Fuel Storage | 3-37 |
| Aircraft Rescue and Firefighting (ARFF)..... | 3-37 |
| Snow and Ice Removal | 3-38 |
| Wash Rack..... | 3-38 |
| Fencing | 3-39 |
| Airport Maintenance Building..... | 3-39 |
| Wildlife Hazard Management..... | 3-39 |
| Utilities..... | 3-40 |
| SUMMARY..... | 3-40 |

Chapter Four ALTERNATIVES

| | |
|--|------|
| AIRPORT DEVELOPMENT OBJECTIVES..... | 4-2 |
| AIRFIELD ALTERNATIVES..... | 4-3 |
| Airfield Design Standards | 4-3 |
| Runway 18-36..... | 4-4 |
| Runway 17-35..... | 4-10 |
| Runway 14-32..... | 4-14 |
| Airspace Analysis | 4-16 |
| LANDSIDE ALTERNATIVES | 4-18 |
| PASSENGER TERMINAL BUILDING ALTERNATIVES..... | 4-19 |
| Terminal Building Alternatives | 4-21 |
| GENERAL AVIATION DEVELOPMENT ALTERNATIVES..... | 4-22 |
| General Aviation Alternatives..... | 4-22 |
| Aviation Support Facilities..... | 4-23 |
| SUMMARY..... | 4-25 |

Chapter Five

RECOMMENDED MASTER PLAN CONCEPT

| | |
|---|-----|
| RECOMMENDED MASTER PLAN CONCEPT | 5-2 |
| Airfield Design Standards | 5-2 |
| Airside Recommendations | 5-3 |
| Landside Planning Recommendations | 5-7 |
| Terminal Building Recommendations..... | 5-8 |
| SUMMARY..... | 5-9 |

Chapter Six

CAPITAL IMPROVEMENT PLAN

| | |
|--|------|
| AIRPORT DEVELOPMENT SCHEDULES AND COST SUMMARIES..... | 6-1 |
| Short Term Improvements..... | 6-3 |
| Intermediate Term Improvements | 6-5 |
| Long Term Improvements | 6-6 |
| Capital Improvement Summary..... | 6-7 |
| PAVEMENT MAINTENANCE | 6-7 |
| CAPITAL IMPROVEMENT FUNDING SOURCES | 6-8 |
| Federal Grants | 6-8 |
| Passenger Facility Charges | 6-11 |
| State Funding Programs..... | 6-12 |
| FAA Facilities and Equipment Program..... | 6-13 |
| SUMMARY..... | 6-13 |

EXHIBITS

| | | |
|----|---|-----------------|
| IA | MASTER PLAN PROCESS | after page iv |
| 1A | LOCATION MAP | after page 1-2 |
| 1B | AIRSIDE FACILITIES | after page 1-12 |
| 1C | AIRSPACE CLASSIFICATION..... | after page 1-18 |
| 1D | VICINITY AIRSPACE | after page 1-18 |
| 1E | TERMINAL AREA FACILITIES..... | after page 1-26 |
| 1F | PASSENGER TERMINAL BUILDING | after page 1-26 |
| 1G | LINCOLN AIRPORT UTILITIES | after page 1-32 |
| 2A | U.S. LARGE AIR CARRIER AND REGIONAL/ COMMUTER FORECASTS..... | after page 2-4 |
| 2B | U.S. ACTIVE GENERAL AVIATION AIRCRAFT FORECASTS | after page 2-10 |

EXHIBITS (Continued)

| | | |
|----|--|-----------------|
| 2C | TOP 20 ORIGIN-DESTINATION MARKETS/ NON-STOP SERVICE DESTINATIONS..... | after page 2-18 |
| 2D | HISTORICAL ENPLANEMENTS | after page 2-18 |
| 2E | 12-MONTH MOVING ENPLANEMENT TOTALS..... | after page 2-20 |
| 2F | ENPLANEMENT FORECAST SUMMARY | after page 2-30 |
| 2G | BASED AIRCRAFT PROJECTIONS..... | after page 2-40 |
| 2H | GENERAL AVIATION FORECASTS | after page 2-44 |
| 2J | FORECAST SUMMARY..... | after page 2-46 |
| | | |
| 3A | AIRFIELD CAPACITY FACTORS..... | after page 3-6 |
| 3B | AIRFIELD DEMAND VS. CAPACITY..... | after page 3-10 |
| 3C | AIRPORT REFERENCE CODES..... | after page 3-12 |
| 3D | WINDROSES..... | after page 3-12 |
| 3E | AIRPORT HOT SPOTS/SAFETY AREAS | after page 3-18 |
| 3F | TERMINAL BUILDING ANALYSIS | after page 3-26 |
| 3G | AIRSIDE REQUIREMENTS | after page 3-40 |
| 3H | LANDSIDE REQUIREMENTS..... | after page 3-40 |
| | | |
| 4A | PLANNING ISSUES..... | after page 4-4 |
| 4B | OBJECT FREE AREA ALTERNATIVES | after page 4-4 |
| 4C | RUNWAY WIDTH ALTERNATIVES | after page 4-6 |
| 4D | RUNWAY LENGTH ALTERNATIVE..... | after page 4-8 |
| 4E | RUNWAY INTERSECTION ALTERNATIVE..... | after page 4-8 |
| 4F | RUNWAY 17-35 ALTERNATIVE 1..... | after page 4-12 |
| 4G | RUNWAY 17-35 ALTERNATIVE 2..... | after page 4-12 |
| 4H | RUNWAY 14-32 ALTERNATIVE | after page 4-14 |
| 4J | PROPOSED PROPERTY ACQUISITION | after page 4-20 |
| 4K | TERMINAL BUILDING EXPANSION SCHEMES | after page 4-22 |
| 4L | TERMINAL EXPANSION ALTERNATIVE..... | after page 4-22 |
| 4M | GENERAL AVIATION TERMINAL AREA LAYOUT..... | after page 4-24 |
| 4N | GENERAL AVIATION EXPANSION | after page 4-24 |
| 4P | POTENTIAL CARGO FACILITY LOCATIONS..... | after page 4-24 |
| | | |
| 5A | RECOMMENDED MASTER PLAN CONCEPT..... | after page 5-2 |
| | | |
| 6A | CAPITAL IMPROVEMENT PROGRAM | after page 6-4 |
| 6B | DEVELOPMENT STAGING | after page 6-4 |
| 6C | PAVEMENT MAINTENANCE | after page 6-8 |
| | | |
| B1 | FLOODPLAINS AND WETLANDS..... | after page B-4 |

Appendix A
GLOSSARY OF TERMS

Appendix B
ENVIRONMENTAL EVALUATION

Appendix C
LETTERS

Appendix D
AIRPORT PLANS

Lincoln Airport

INTRODUCTION

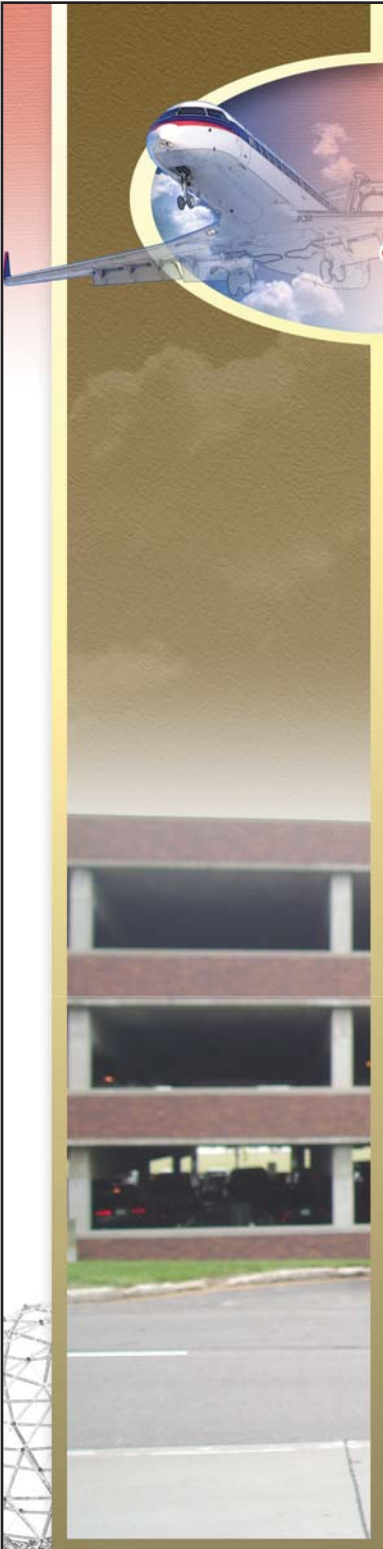

Lincoln Airport

INTRODUCTION

The Lincoln Airport (LNK) Master Plan Study Update has been undertaken to evaluate the airport's capabilities and role; to forecast future aviation demand; and to plan for the timely development of new or expanded facilities that may be required to meet that demand. The ultimate goal of the master plan is to provide systematic guidelines for the airport's overall maintenance, development, and operation.

The master plan is intended to be a proactive document which identifies and then plans for future facility needs well in advance of the actual need for the facilities. This is done to ensure that the Lincoln Airport Authority can coordinate project approvals, design, financing, and construction to avoid experiencing detrimental effects due to inadequate facilities.

An important result of the master plan is reserving sufficient areas for future facility needs. This protects development areas and ensures they will be readily available when required to meet future needs. The intended result is a detailed land use concept which outlines specific uses for all areas of airport property.

The preparation of this master plan is evidence that the Lincoln Airport Authority recognizes the importance of air transportation to the community as well as the unique challenges operating an airport presents. The investment in an airport yields many benefits to the community and the region. With a sound and realistic master plan, Lincoln Airport can maintain its important link to the national air transportation system for the community and maintain the existing public

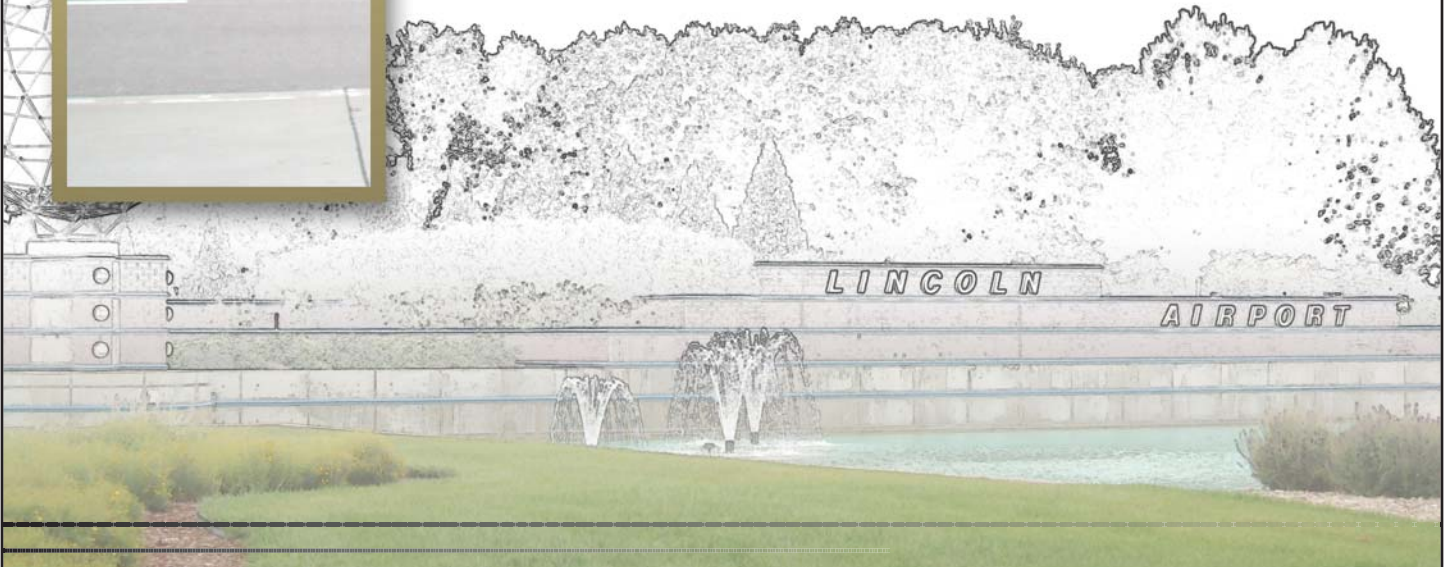

and private investments in its facilities.

MASTER PLAN OBJECTIVES

The primary objective of the master plan is to provide the community and its leadership with guidance for operating the airport in a safe and efficient manner while planning for future demand levels. Accomplishing this objective requires a comprehensive evaluation of the existing airport and a determination of what actions should be taken to maintain a safe and reliable airport facility while meeting the aviation needs of the region. This master plan will provide a vision for the airport covering the next 20 years and, in some cases, beyond. With this vision, the Airport Authority will have advance notice of potential future airport funding needs so that appropriate steps can be taken to ensure that adequate funds are budgeted and planned.

Specific objectives of the Lincoln Airport Master Plan Update are:

- & To preserve and protect public and private investments in existing airport facilities;
- & To enhance the safety of aircraft operations;
- & To be reflective of community and regional goals, needs, and plans;
- & To ensure that future development is environmentally compatible;

- & To establish a schedule of development priorities designed to meet forecast aviation demand;
- & To develop a plan that is responsive to air transportation demands;
- & To develop an orderly plan for use of the airport;
- & To meet FAA airport design standards;
- & To coordinate this master plan with local, regional, state, and federal agencies, and;
- & To develop active and productive public involvement throughout the planning process.

The master plan will accomplish these objectives by carrying out the following:

- & Determining projected needs of airport users through the year 2025;
- & Analyzing socioeconomic factors likely to effect air transportation demand in the Lincoln area;
- & Identifying potential existing and future land acquisition needs;
- & Evaluating future airport facility development alternatives which will optimize airport capacity and aircraft safety;

- % Developing a realistic, common-sense plan for the use and/or expansion of the airport.
- % Present environmental consideration associated with any recommended development alternatives;
- % Produce current and accurate airport base maps and Airport Layout Plans; and
- % Develop a Geographic Information System (GIS) for use in the implementation, coordination, and monitoring of the Master Plan and the previously approved Part 150 Noise Compatibility Plan.

MASTER PLAN ELEMENTS AND PROCESS

The Lincoln Airport Master Plan Update is being prepared in a systematic fashion following FAA guidelines and industry-accepted principles and practices, as shown on **Exhibit IA**. The master plan has six chapters that are intended to assist in the discovery of future facility needs and provide the supporting rationale for their implementation.

Chapter One - Inventory summarizes the inventory efforts. The inventory efforts are focused on collecting and assembling relevant data pertaining to the airport and the area it serves. Information is collected on existing airport facilities and operations. Local economic and demographic data is collected to define the local growth

trends. Planning studies which may have relevance to the master plan are also collected.

Chapter Two - Forecasts examines the potential aviation demand at the airport. The analysis utilizes local socioeconomic information, as well as national air transportation trends, to quantify the levels of aviation activity which can reasonably be expected to occur at Lincoln Airport through the year 2025. The results of this effort are used to determine the types and sizes of facilities which will be required to meet the projected aviation demand at the airport through the planning period.

Chapter Three - Facility Requirements comprises the demand capacity and facility requirements analyses. The intent of this analysis is to compare the existing facility capacities to forecast aviation demand and determine where deficiencies in capacities (as well as excess capacities) may exist. Where deficiencies are identified, the size and type of new facilities to accommodate the demand are identified. The airfield analysis focuses on improvements needed to safely serve the type of aircraft expected to operate at the airport in the future, as well as navigational aids to increase the safety and efficiency of operations. This element also examines the general aviation terminal, hangar, apron, and support needs.

Chapter Four - Alternatives considers a variety of solutions to accommodate the projected facility needs. This element proposes various facility and site plan configurations which can

meet the projected facility needs. An analysis is completed to identify the strengths and weaknesses of each proposed development alternative, with the intention of determining a single direction for development.

Chapter Five - Airport Plans provides both a graphic and narrative description of the recommended plan for the use, development, and operation of the airport. An environmental overview is also provided. The master plan also includes the official Airport Layout Plan (ALP) and detailed technical drawings depicting related airspace, land use, and property data. These drawings are used by the Federal Aviation Administration (FAA) in determining grant eligibility and funding.

Chapter Six - Financial Plan focuses on the capital needs program which defines the schedules, costs, and funding sources for the recommended development projects.

COORDINATION

The Lincoln Airport Master Plan Update is of interest to many within the

local community. This includes local citizens, community organizations, airport users, airport tenants, area-wide planning agencies, and aviation organizations. As an important component of the regional, state, and national aviation systems, the Lincoln Airport is of importance to both state and federal agencies responsible for overseeing air transportation.

To assist in the development of the master plan, the Airport Authority has identified a group of community members and aviation interest groups to act in an advisory role in the development of the master plan. Members of the Planning Advisory Committee (PAC) will review phase reports and provide comments throughout the study to help ensure that a realistic, viable plan is developed.

To assist in the review process, draft phase reports will be prepared at the various milestones in the planning process. The phase report process allows for timely input and review during each step within the master plan to ensure that all master plan issues are fully addressed as the recommended program develops.

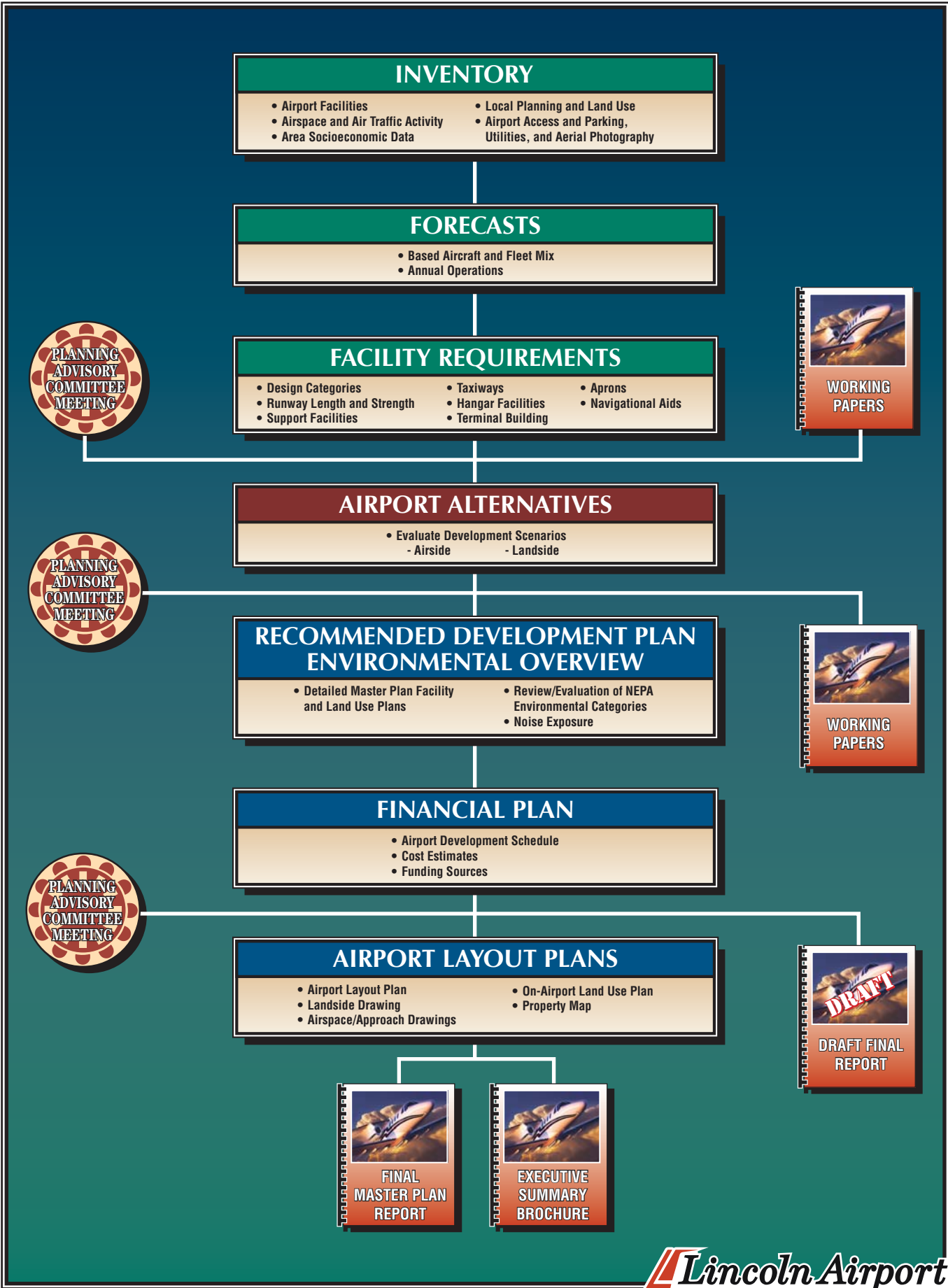

INVENTORY

- Airport Facilities
- Local Planning and Land Use
- Airspace and Air Traffic Activity
- Airport Access and Parking, Utilities, and Aerial Photography
- Area Socioeconomic Data

FORECASTS

- Based Aircraft and Fleet Mix
- Annual Operations

FACILITY REQUIREMENTS

- Design Categories
- Taxiways
- Aprons
- Runway Length and Strength
- Hangar Facilities
- Navigational Aids
- Support Facilities
- Terminal Building

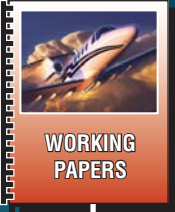

AIRPORT ALTERNATIVES

- Evaluate Development Scenarios
 - Airside
 - Landside



RECOMMENDED DEVELOPMENT PLAN ENVIRONMENTAL OVERVIEW

- Detailed Master Plan Facility and Land Use Plans
- Review/Evaluation of NEPA Environmental Categories
- Noise Exposure

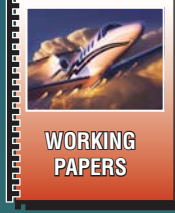

FINANCIAL PLAN

- Airport Development Schedule
- Cost Estimates
- Funding Sources



AIRPORT LAYOUT PLANS

- Airport Layout Plan
- On-Airport Land Use Plan
- Landside Drawing
- Property Map
- Airspace/Approach Drawings

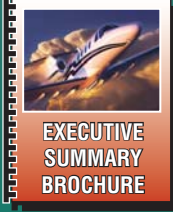

Lincoln Airport

INVENTORY

The initial step in the preparation of the master plan update for Lincoln Airport (LNK) is the collection of information pertaining directly to or influencing the airport and the area it serves. The information summarized in this chapter will be used in subsequent analyses in this study and includes:

- Physical inventories and descriptions of the facilities and services currently provided at the airport, including the regional airspace, air traffic control, and aircraft operating procedures.
- Background information pertaining to the City of Lincoln and the regional area, including descriptions of the regional climate, surface transportation systems, and Lincoln Airport's role in regional, state, and

national aviation systems. Development at the airport since the completion of the previous master plan will also be presented.

- Population and other significant socioeconomic data which can provide an indication of future trends that could influence aviation activity at the airport.
- A review of existing local and regional plans and studies to determine their potential influence on the development and implementation of the airport master plan.

The information outlined in this chapter provides a foundation for all subsequent chapters. The information



was obtained through on-site inspections of the airport, interviews with airport staff and tenants, and documents prepared by the Federal Aviation Administration (FAA), Lancaster County, the City of Lincoln, and regional planning agencies.

REGIONAL SETTING

LOCATION

As depicted on **Exhibit 1A**, the Lincoln Airport is located in the center of Lancaster County. It is situated approximately five miles to the northwest of the City of Lincoln's central business district, and primarily within the city limits. The Lincoln Airport is located on approximately 5,500 acres of property. The City of Lincoln is the Capital of the State of Nebraska and is home to the University of Nebraska. Lincoln is the second largest populated city in Nebraska, trailing only Omaha.

REGIONAL TRANSPORTATION NETWORK

The primary access to Lincoln Airport is West Adams Street which serves as a loop road for the airport terminal area. West Cornhusker Highway (State Spur Route L-55L), U.S. Route 77, Interstate 80, and Route 6 provide the primary surface transportation routes to and from the airport.

The west side of the airport supports aviation and non-aviation opportunities in the Lincoln Airpark. Primary

access to this business park is from NW 48th Street. This road connects to the north to State Highway 34 and to the south to Interstate 80.

CLIMATE

Weather conditions are important to the planning and development of an airport. Temperature is an important factor in determining runway length requirements, while wind direction and speed are used to determine optimum runway orientation. The need for navigational aids and lighting is determined by the percentage of time that visibility is impaired due to cloud coverage or other conditions. **Table 1A** summarizes climatic data for the City of Lincoln.

Summers in Lincoln can vary from very hot weather with persistent southerly winds, to periods with precipitation associated with thunderstorm activity. Temperatures typically range from 60 to 90 degrees Fahrenheit (F) during the summer months. The hottest month on average is July, averaging 88 degrees. Extended periods of very hot weather exceeding 100 degrees can occur sporadically. Lincoln averages nearly 30 inches of precipitation throughout the year. May is the wettest month averaging 4.5 inches of rain.

January is the coldest month with an average low temperature of 13° F. Snowfall in the Lincoln area averages nearly 28 inches annually. From December through March, monthly snow accumulation averages more than five inches. Winter storm fronts are typi-

01SP21-1A-6/12/02



Lincoln Airport

Exhibit 1A
LOCATION MAP

cally accompanied by strong north-westerly winds.

The average annual wind speed at Lincoln Airport is 10.05 miles per hour. The month of April experiences

the highest average wind speeds of 12.1 miles per hour. The strongest winds typically come out of the north-northwest. Southerly gusts are also experienced during the warm summer months.

TABLE 1A
Climatological Data
Lincoln, Nebraska

| Month | Monthly Temperature Averages | | Precipitation Mean (inches) | Snowfall Mean (inches) | Wind Speed Average (MPH) |
|-----------|------------------------------|-------------|-----------------------------|------------------------|--------------------------|
| | Maximum (f) | Minimum (F) | | | |
| January | 33 | 13 | 0.59 | 6.10 | 9.60 |
| February | 40 | 18 | 0.69 | 5.70 | 10.00 |
| March | 51 | 28 | 2.27 | 5.90 | 11.30 |
| April | 63 | 39 | 2.87 | 1.40 | 12.10 |
| May | 74 | 50 | 4.52 | 0.10 | 10.50 |
| June | 84 | 61 | 3.95 | 0.00 | 9.80 |
| July | 88 | 66 | 3.97 | 0.00 | 9.30 |
| August | 86 | 64 | 3.56 | 0.00 | 9.10 |
| September | 79 | 54 | 2.75 | 0.00 | 9.50 |
| October | 67 | 41 | 2.12 | 0.60 | 9.90 |
| November | 50 | 28 | 1.57 | 2.80 | 9.90 |
| December | 37 | 17 | 0.85 | 5.20 | 9.60 |
| Totals | 63 | 40 | 29.71 | 27.80 | 10.10 |

Source: www.weather.com; NOAA

AIRPORT HISTORY

In April 1928, a bond issue was approved to acquire the necessary land to develop a municipal airport. The City then purchased 160 acres, which was graded and seeded during the next year. Development continued with the construction of asphalt runways, access roads, and the installation of lighting systems. A house was also remodeled to serve as an office and waiting area. On June 12, 1930, the Lincoln Municipal Airport was dedicated.

In February 1941, the City requested the inclusion of the airport in the national defense program, and seven months later, the Federal government

requested permission to utilize the Airport. Within the next year, the U.S. Army initiated the construction of facilities on the Airport. The United States spent in excess of \$20 million for the construction. In return, the City was requested to furnish 2,750 acres of land and the required water and electricity. On October 4, 1942, formal dedication of the Lincoln Army Airfield took place.

In December 1945, Lincoln Army Airfield became temporarily inactive, and seven months later was declared surplus. The Federal government surrendered its lease in December 1948, which provided the transfer of the right, title, and interest in the facili-

ties constructed upon airport land in its entirety to the City of Lincoln.

In 1952, the United States Air Force leased the airfield, bought additional property, and developed the Air Force Base. It was recommended that the Air Force permit civil operations at the airport and that the City provide alternate airport facilities to accommodate civil traffic.

In November 1964, the USAF returned the airfield to the City of Lincoln (as received by the newly created Lincoln Airport Authority [LAA]). During the 12-year period that USAF leased the airport, they purchased 850 acres of land and extended the primary runway to the south. This property was included in the overall lease return to the City, but was treated separately and has separate deed restrictions on its use.

On September 15, 1966, the LAA assumed the responsibility of providing crash response for the airport. The original fire station was located on the west ramp. Policing and security of the airport was provided through agreement with the Lincoln Police Department and the Nebraska State Patrol.

The current airline complex, which includes a two-level terminal building, aircraft parking apron, connecting taxiways, access roads and vehicle parking, was opened for operation on December 4, 1974. The FAA airport traffic control tower located in the terminal complex was dedicated on

August 22, 1975. In December 1987, a 529-car parking garage was completed in the terminal area.

In 2004, the name of the airport formally changed from the Lincoln Municipal Airport to the Lincoln Airport.

RECENT CAPITAL IMPROVEMENTS

To assist in funding capital improvements, the Federal Aviation Administration (FAA) has provided funding assistance to Lincoln Airport through the Airport Improvement Program (AIP). The AIP is funded through the Aviation Trust Fund, which was established in 1970 to provide funding for aviation capital investment programs (aviation development, facilities and equipment, and research and development). The Trust Fund also finances a portion of the operation of the FAA. It is funded by user fees, taxes on airline tickets, aviation fuel, and various aircraft parts.

Table 1B summarizes FAA AIP grants for Fiscal Year (FY) 1998 through FY 2006. The FAA has provided \$15.2 million for airport improvements at Lincoln Airport over the past eight years.

Between 1996 and 2005, the Nebraska Department of Aeronautics (NDOA) invested almost \$724,000 in improvements at Lincoln Airport. **Table 1C** summarizes these projects and their total expenditures over this nine-year period.

**TABLE 1B
Federal Grants Offered to Lincoln Airport**

| Fiscal Year | AIP Grant Number | Project Description | Total Grant Funds |
|--------------------------------|-------------------------|--|--------------------------|
| 1998 | 3-31-0050-23 | Replace/Upgrade security access system; snow removal equipment; Rehabilitate Taxiway A and E; Security fence | \$1,561,500 |
| 1999 | 3-31-0050-24 | Snow removal equipment; Install REILs for Runway 35R; Fiber optics installation to ATCT | \$551,800 |
| 1999 | 3-31-0050-25 | Construct hangar service road and gates; construct hangar taxilane | \$544,500 |
| 2000 | 3-31-0050-26 | Install REILs for Runway 17L | \$223,177 |
| 2001 | 3-31-0050-27 | Rehabilitate Runway 14-32; Install MIREL Runway 14-32; Displace Runway 14 threshold; Relocate NAVAIDs, RSA improvements | \$5,214,128 |
| 2002 | 3-31-0050-28 | FAR Part 150 Noise Compatibility Study | \$261,000 |
| 2002 | 3-31-0050-29 | Improve/Modify Terminal Building (Phase I); Security enhancement | \$1,886,179 |
| 2002 | 3-31-0050-30 | Compensation for new security costs | \$247,364 |
| 2003 | 3-31-0050-31 | Improve/Modify terminal building (Phase II); Security enhancement | \$390,045 |
| 2004 | 3-31-0050-32 | Redesignate Runways 17R-35L to 18-36 and 17L-35R to 17-35; Security enhancements; Renovate terminal building (Phase III) | \$1,095,483 |
| 2005 | 3-31-0050-33 | Rehabilitate Runway 17-35; Rehabilitate Taxiways G & J, and service road; Security enhancements; Install signage; Install ODALs for Runway 35; Relocate wind cones | \$902,500 |
| 2006 | 3-31-0050-34 | Improve service roads; Rehabilitate terminal skywalk; Modify terminal building; Install Runway 14-32 sensors; Surface treatments for Taxiway A and Runway 14-32 | \$1,451,582 |
| 2006 | 3-31-0050-35 | Update Airport Master Plan | \$415,000 |
| 2006 | 3-31-0050-36 | Improve Runway 18-36 RSA (Phase I) | \$522,500 |
| Total Grant Funds | | | \$15,266,758 |
| <i>Source: Airport Records</i> | | | |

| Fiscal Year | NDOA Grant Number | Project Description | Total Grant Funds |
|-------------------------|--------------------------|--|--------------------------|
| 1996 | SA-19 | Overlay Terminal Road | \$100,000 |
| 1997 | SA-20 | Drainage Improvements | \$51,688 |
| 1998 | SA-21 | Apron in front of NDA Building | \$172,110 |
| 1998 | SA-22 | Mill & overlay Runway 32 displaced threshold | \$100,000 |
| 2000 | SA-23 | Terminal area drainage | \$100,000 |
| 2001 | SA-24 | Pave GA parking lot | \$100,000 |
| 2003 | SA-25 | North Park Road – Pavement repair & surface improvements | \$100,000 |
| Total State Grant Funds | | | \$723,798 |

Source: Nebraska Department of Aeronautics

AIRPORT ADMINISTRATION

The Airport Authority of the City of Lincoln, Nebraska was created on February 16, 1959, under the authority of Article 5 of Chapter 3, Revised Statutes of Nebraska. Five citizens of the City were appointed by the Mayor and confirmed by the City Council on this date as members of the Board of the Authority. Under the provisions of the Airport Authority Act, the governing Board of the Authority is a body of corporate and politic constituting a public corporation. The members of the Board receive no compensation for their services. Day-to-day operation of the airport is charged to a professional Airport Director and a support staff. The director is hired by the Board.

THE AIRPORT'S SYSTEM ROLE

Airport planning exists on many levels: local, regional, state, and national. Each level has a different emphasis

and purpose. The airport master plan typically serves as the primary local airport planning document. Other local, regional, and state planning studies previously conducted pertaining to the airport have been reviewed and are summarized below.

The role of the federal government in the development of airports cannot be overstated. Many of the nation's existing airports were either initially constructed by the federal government or their development and maintenance was partially funded through various federal grant-in-aid programs to local communities. In large measure, the system of airports existing today is due, in part, to the existence of federal policy that promotes the development of civil aviation. As part of a continuing effort to develop a national airport system to meet the needs of civil aviation and promote air commerce, the United States Congress has continually maintained a national plan for the development and maintenance of airports.

The current national airport system plan is the National Plan of Integrated Airport Systems (NPIAS) 2005-2009. A primary purpose of the NPIAS is to identify the airports that are important to national transportation and includes all commercial service airports, all reliever airports, and selected general aviation airports. A total of 3,344 airports are identified in the NPIAS.

The Lincoln Airport is classified as a primary commercial service airport in the NPIAS. This classification does not restrict or prevent its use by general aviation or military aircraft; rather, it is intended to reflect the airport's capacity to provide the highest level of public services and accommodations for some of the largest, most-sophisticated aircraft in the commercial and general aviation fleet. This classification is also used as a funding category for the distribution of federal aid.

An additional classification of the airport is provided to indicate the amount of revenue-generating passengers that may be found in a given metropolitan area served by the airport. The percentage of revenue-producing passengers in a given metropolitan area (referred to as a hub) is determined by dividing the number of annual passenger enplanements at the airport into the number of annual enplanements nationwide. This percentage then falls within a predetermined hub classification: large, medium, small, or non-hub.

The Lincoln Airport is classified as a non-hub primary commercial service

airport. Commercial service airports that enplane less than 0.05 percent of all commercial passenger enplanements but more than 10,000 annual enplanements are categorized as such. There are 243 non-hub primary airports that together account for three percent of all enplanements. These airports are heavily used by general aviation aircraft, with an average of 95 based aircraft.

On the state level, the Nebraska Department of Aeronautics maintains the Nebraska Aviation System Plan (NASP). The most recent NASP was completed in March of 2002 and identifies 90 state system airports. In the NASP, Lincoln Airport is identified as one of 10 airports in the state providing scheduled commercial service. The NASP further identifies 17 airports, including the Lincoln Airport, as National Airports.

National Airports, as defined in the NASP, are recommended to provide a defined level of service in both facilities and airfield development. For example, National Airports should have a primary runway length intended to meet the needs of 75 percent of large cabin-class business jets as 60 percent useful load, as well as any additional length necessary to accommodate scheduled commercial service aircraft. Other necessities include precision approaches, full parallel taxiways, runway orientation to provide at least 95 percent wind coverage, and land-side facilities to meet aviation needs.

AVIATION ACTIVITY

Records of airport operational activity are essential for determining required facilities (types and sizes), as well as eligibility for federal funding. Airport staff and the FAA record key operational statistics including aircraft operations, enplaned passengers, and cargo shipments. Analysis of historical activity levels aid in projecting future trends which will enhance the airport's ability to plan for facility demands in a timely manner. The following sections detail specific operational activities.

AIRCRAFT OPERATIONS

Aircraft operational statistics at Lincoln Airport are recorded by the airport traffic control tower (ATCT) that is operated by the FAA between 5:30

a.m. and 12:00 p.m. daily. Among other duties, the ATCT counts aircraft operations, which are defined as either a takeoff or a landing. Aircraft operations are segregated into four general categories: air carrier, air taxi, military, and general aviation. Air carrier operations are performed by commercial airline aircraft with greater than 60 seats. Air taxi operations are generally associated with commuter aircraft, but also include for-hire general aviation aircraft.

Operations are further sub-categorized as either itinerant or local. Itinerant operations are those made by aircraft which arrive from or depart to destinations outside the local operating area. Local operations are associated primarily with touch-and-go or pilot training activity. **Table 1D** presents a summary of operations since 1997.

TABLE 1D
Historical Aircraft Operations by Category
Lincoln Municipal Airport

| Year | Air Carrier | Itinerant | | | | Local | | | Total |
|-------|-------------|-----------|------------------|----------|----------|------------------|----------|----------|---------|
| | | Air Taxi | General Aviation | Military | Subtotal | General Aviation | Military | Subtotal | |
| 1997 | 5,958 | 10,063 | 41,063 | 12,491 | 69,575 | 35,164 | 12,588 | 47,752 | 117,327 |
| 1998 | 5,845 | 10,650 | 41,985 | 13,107 | 71,587 | 34,719 | 13,293 | 48,012 | 119,599 |
| 1999 | 6,352 | 11,185 | 45,175 | 12,416 | 75,128 | 36,100 | 11,948 | 48,048 | 123,176 |
| 2000 | 6,244 | 12,145 | 47,855 | 10,999 | 77,243 | 37,201 | 10,037 | 47,238 | 124,481 |
| 2001 | 4,388 | 13,875 | 40,805 | 12,674 | 71,742 | 27,006 | 7,194 | 34,200 | 105,942 |
| 2002 | 2,062 | 19,491 | 39,208 | 14,644 | 75,405 | 19,234 | 6,441 | 25,675 | 101,080 |
| 2003 | 12,824 | 6,190 | 36,146 | 15,749 | 70,909 | 15,619 | 5,652 | 21,271 | 92,180 |
| 2004 | 13,005 | 7,017 | 32,965 | 17,549 | 70,536 | 10,588 | 6,227 | 16,765 | 87,301 |
| 2005 | 12,645 | 5,629 | 31,097 | 13,331 | 62,702 | 8,481 | 5,494 | 13,975 | 76,677 |
| 2006* | 11,032 | 3,471 | 27,195 | 13,308 | 54,906 | 12,188 | 23,870 | 36,055 | 90,964 |

* 2006 Jan.-Oct. Tower Records, Nov.-Dec. estimated based on Jan. - Oct. average.
 Sources: 2003-2006 Tower Records; 1997-2002 FAA TAF.

Itinerant operations have historically accounted for up to 82 percent of overall operations at the airport. This is an indicator that Lincoln Airport attracts aviation activity from outside of its service area. This is attributable to a combination of regular air carrier activity, significant military activity, and strong general aviation activity. The general aviation itinerant activity is likely attracted by the two FBOs on the east ramp and the large aviation maintenance operation. It should be noted that 2006 operations are trending up following five years of decline. Much of this is likely the result of activity conducted by Offutt AFB, which has temporarily relocated many aircraft to the west ramp at Lincoln.

PASSENGER ACTIVITY

Passenger traffic is collected and analyzed by recording the number of passengers who arrive (deplane) or depart (enplane) commercial service aircraft; however, only enplanement levels are used by the FAA and for planning. Passenger enplanement figures are the planning yardstick utilized to determine terminal building space capacities, automobile parking requirements, automobile access capacities, etc. Also, the FAA provides annual entitlement funds based upon the level of enplanements reached at the airport. Passenger levels on each flight are recorded by the airlines and reported to the airport and the FAA on a monthly basis. **Table 1E** presents historical enplanement levels at Lincoln Airport since 1997.

| Year | Passengers | | Total |
|------|--------------|--------------|---------|
| | Enplanements | Deplanements | |
| 1997 | 264,317 | 261,994 | 526,311 |
| 1998 | 251,031 | 252,984 | 504,015 |
| 1999 | 282,624 | 279,209 | 561,833 |
| 2000 | 266,375 | 264,348 | 530,723 |
| 2001 | 239,041 | 231,908 | 470,949 |
| 2002 | 230,389 | 230,482 | 460,871 |
| 2003 | 211,594 | 208,286 | 419,880 |
| 2004 | 221,228 | 220,934 | 442,162 |
| 2005 | 202,917 | 200,849 | 403,766 |

Source: Lincoln Airport Authority

As of August 2006, there were three commercial passenger airline carriers with scheduled service to the airport. Northwest Airlink, operated by Pinnacle Airlines Inc., operates daily non-stop flights to Detroit and Minneapolis

utilizing a Canadian Regional Jet (CRJ). United Express provides daily non-stop flights to Denver and Chicago, also utilizing a CRJ. Allegiant Air provides a Wednesday and Saturday departure to Las Vegas and a

Wednesday and Saturday arrival from Las Vegas utilizing a MD83. **Table**

1F presents a consolidated flight schedule as of August 2006.

| TABLE 1F | | | | | | | | |
|---|----------------|-------------|------------------|-----------------|------------------|-------------|------------------|-----------------|
| Consolidated Flight Schedule (July 2006) | | | | | | | | |
| Lincoln Airport | | | | | | | | |
| UNITED EXPRESS | | | | | | | | |
| Flight # | Arrival | From | Frequency | Flight # | Departure | To | Frequency | Aircraft |
| | | | | 7204 | 6:00 AM | Chicago | Daily | CRJ |
| | | | | 6764 | 7:15 AM | Denver | Daily | CRJ |
| 5887 | 9:45 AM | Chicago | Daily | 6549 | 10:15 AM | Denver | Daily | CRJ |
| 7129 | 12:15 PM | Chicago | Daily | 7129 | 12:47 PM | Chicago | Daily | CRJ |
| 6706 | 12:50 PM | Denver | Daily | 6706 | 1:28 PM | Denver | Daily | CRJ |
| 7133 | 1:39 PM | Chicago | Daily | 7133 | 2:09 PM | Chicago | Daily | CRL |
| 6708/6748 | 3:43 PM | Denver | M-F/SA-SU | 6708/6748 | 4:11 PM | Denver | M-F/SA-SU | CRJ |
| 6710 | 5:59 PM | Denver | Daily | 6861 | 6:25 PM | Chicago | Daily | CRJ |
| 7259 | 9:30 PM | Chicago | Daily | | | | | |
| 6704 | 9:51 PM | Denver | Daily | | | | | |
| NORTHWEST AIRLINK/PINNACLE | | | | | | | | |
| | | | | 5646 | 6:34 AM | Minneapolis | Ex SU | CRJ |
| 5652 | 10:30 AM | Minneapolis | Ex SU | 5643 | 10:55 AM | Minneapolis | Daily | CRJ |
| 3770 | 12:38 PM | Minneapolis | Daily | 5645 | 1:05 PM | Minneapolis | Daily | CRJ |
| 2861 | 2:25 PM | Minneapolis | Daily | 2816 | 2:50 PM | Minneapolis | Daily | CRJ |
| 3700 | 4:26 PM | Detroit | Daily | 2970 | 4:51 PM | Detroit | Daily | CRJ |
| 5636 | 6:12 PM | Minneapolis | Ex SA | 5641 | 6:37 PM | Minneapolis | Ex SA | CRJ |
| 5650 | 10:50 PM | Minneapolis | Daily | | | | | |
| ALLEGiant AIR | | | | | | | | |
| 482 | 12:20 PM | Las Vegas | W & SA | 483 | 1:00 PM | Las Vegas | W & SA | MD83 |

Source: Lincoln Airport Authority

CARGO ACTIVITY

Air cargo is an encompassing term used to describe the combined activities of air mail and air freight operations. The air cargo industry includes a diverse range of businesses providing a variety of different services supporting the movement of air freight. This includes air cargo transported by dedicated cargo airlines, passenger airlines, freight forwarders and custom brokers, and air freight truckers.

There are currently no dedicated air cargo carriers serving Lincoln Airport. Historical air cargo enplaned and de-

planed at the airport is presented in **Table 1G**. As can be seen, air cargo, as measured in pounds, has steadily declined over the past 10 years. Two factors have been influential in the reduction in mail and air freight cargo at Lincoln Airport. First, the U.S. Postal Service recently made a business decision to utilize all-cargo carriers rather than passenger airplanes for air mail transport. Second, the change in the commercial aircraft fleet operating at the airport from larger mainline aircraft to regional jets has significantly reduced space available for cargo or mail.

TABLE 1G
Annual Cargo and Mail (in pounds)
Lincoln Airport

| Year | CARGO | | MAIL | |
|------|---------|---------|-----------|---------|
| | Enplane | Deplane | Enplane | Deplane |
| 1997 | 125,743 | 557,002 | 3,070,827 | 31,071 |
| 1998 | 120,156 | 466,589 | 3,404,504 | 30,673 |
| 1999 | 118,605 | 439,402 | 2,017,984 | 31,346 |
| 2000 | 82,640 | 382,722 | 2,108,698 | 27,842 |
| 2001 | 52,571 | 218,976 | 1,041,159 | 13,119 |
| 2002 | 22,203 | 117,774 | 317 | 80 |
| 2003 | 14,124 | 94,797 | 10 | 1 |
| 2004 | 25,033 | 59,364 | 0 | 0 |
| 2005 | 18,177 | 82,229 | 0 | 0 |

Source: Lincoln Airport Authority

AIRFIELD FACILITIES

Airfield facilities include runways, taxiways, airport lighting, and navigational aids. A depiction of airfield facilities at the airport is provided on the aerial photograph on **Exhibit 1B**, while **Table 1H** summarizes airfield facility data.

RUNWAYS

The Lincoln Airport is served by three runways, two of which are aligned in a parallel manner. Primary Runway 18-36 is intersected by crosswind Runway 14-32 approximately 1,500 feet from the northern threshold. Runway 17-35 is the parallel runway, located approximately 3,000 feet to the east of Runway 18-36 and primarily serves general aviation aircraft activity.

Runway 18-36

Runway 18-36 is 12,901 feet long by 200 feet wide and oriented in a north-south manner. The center 100 feet of the runway is constructed of concrete, and 50 feet on either side is asphalt. The surface of the runway is in good condition and is grooved to aid in drainage and wheel traction.

Runway 18-36 has pavement strength of 100,000 pounds single wheel loading (SWL). SWL refers to the design of certain aircraft landing gear that has a single wheel on each main landing gear strut. The runway pavement has also been strength rated at 200,000 pounds dual wheel (DWL) and 400,000 pounds for dual tandem wheel (DTWL). This pavement strength will accommodate most aircraft in the commercial and military fleet today.

| TABLE 1H Airside Facility Data Lincoln Airport | | | |
|--|---|----------------------------|------------------------------------|
| | Runway 18-36 | Runway 14-32 | Runway 17-35 |
| Runway Length (feet) | 12,901 | 8,649 | 5,400 |
| Runway Width (feet) | 200 | 150 | 100 |
| Runway Surface Material | Asphalt/Concrete | Asphalt/Concrete | Asphalt/Concrete |
| Surface Treatment | Grooved | Grooved | Friction Seal Coat |
| Condition | Good | Excellent | Excellent |
| Pavement Markings | Precision | Nonprecision | Nonprecision |
| Runway Load Bearing Strength (lbs.) | | | |
| Single Wheel Loading (SWL) | 100,000 | 80,000 | 49,000 |
| Dual Wheel Loading (DWL) | 200,000 | 170,000 | 60,000 |
| Double Tandem Wheel Loading (DTWL) | 400,000 | 280,000 | NA |
| Runway Lighting | High Intensity (HIRL) | Medium Intensity (MIRL) | High Intensity (HIRL) |
| Taxiway Lighting | Medium Intensity (MIRL) | | |
| Taxiway, Taxilanes & Apron Lighting | Reflectors, Centerline, Tie-down | | |
| Traffic Pattern | Right (18)/Left (36) | Left (14-36) | Left (17)/Right (35) |
| Approach Aids | MALSRL (1,400-foot) PAPI-4L | REIL (14) VASI-4L | REIL (17) PAPI-4L ODALS (35) |
| Instrument Approach Aids | ILS (CAT I) HI-VOR/DME RNAV (GPS) VOR (18) NDB (36) | RNAV (GPS) (14) | VOR (17) GPS (17) |
| Weather and Navigational Aids | Automated Surface Observation System (ASOS) Lighted Wind Cone Airport Beacon Airport Traffic Control Tower (ATCT) Low Level Wind Shear Alert System (LLWAS) Automated Terminal Information System (ATIS) Remote Communications Outlet (RCO) | | |
| PAPI – Precision Approach Path Indicator GPS – Global Positioning System VOR/DME – Very High Frequency Omni-directional Range/Distance Measuring Equipment VASI – Visual Approach Slope Indicator REIL – Runway End Identification Lights MALSRL – Medium Intensity Approach Lighting System with Runway Alignment Indicator Lights | | | |
| <i>Source: Airport/Facility Directory – North Central (September 28, 2006)</i> | | | |

Runway 14-32

Runway 14-32 is 8,649 feet long and 150 feet wide, constructed of asphalt. It is oriented in a northwest to southeast manner. The runway has a rated pavement strength of 80,000 pounds SWL, 170,000 pounds DWL, and 280,000 pounds DTWL. The runway

is in excellent condition and is grooved to improve drainage. The shoulders are 25 feet wide and paved. The Runway 32 landing threshold has been displaced 470 feet due to an obstruction to the approach. The Runway 14 threshold is displaced 363 feet to allow for full runway safety area (RSA) and object free area (OFA) beyond the

KEY

- VASI: Visual Approach Slope Indicators
- PAPI: Precision Approach Slope Indicators
- MALSRL: Medium Intensity Approach Lighting System with Runway Alignment Indicator Lights
- ODALS: Omni-Directional Approach Lighting System
- ILS: Instrument Landing System
- REIL: Runway End Identification Lights
- ASOS: Automated Surface Observation System
- ATCT: Airport Traffic Control Tower
- LLWAS: Low Level Wind Shear Alert System
- NANG: Nebraska Air National Guard
- ARNG: Nebraska Army National Guard

LEGEND

- Airport Property Line
- Avigation Easment
- Airfield Perimeter Fencing

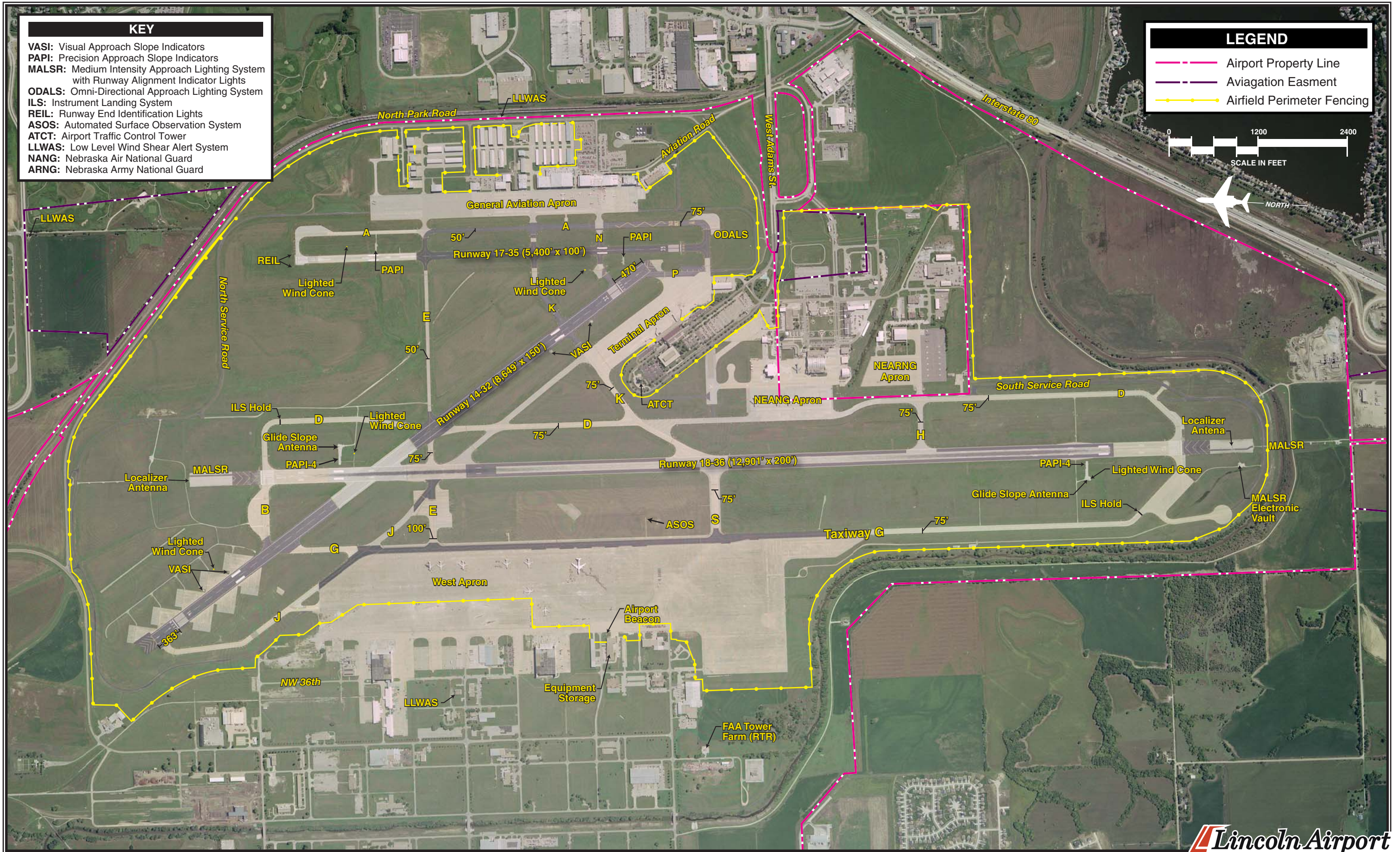

north end of the runway. In addition, declared distances are published for operations to and from both runway ends.

Declared distances are the published runway lengths available for take-off or landing that pilots utilize when calculating runway length needs. Landing operations to Runway 14 allow for 8,286 feet of runway, while landing operations to Runway 32 allow for 7,816 feet. Take-off operations on Runway 14 allow for the full 8,649 feet, while Runway 32 take-off operations are limited to 8,286 feet.

Runway 17-35

Runway 17-35 is parallel to Runway 18-36 and primarily serves the general aviation activity at the airport. The runway is 5,400 feet long by 100 feet wide and is constructed of asphalt and concrete, with a seal coat applied to improve wheel traction. The runway pavement is in excellent condition and has been strength rated at 49,000 pounds SWL and 60,000 pounds DWL. The threshold for Runway 35 is preceded by 400 feet of pavement, which is designated as taxiway.

TAXIWAYS

The taxiway system at Lincoln Airport, as illustrated on **Exhibit 1B**, consists of parallel, connecting, access, and entrance/exit taxiways.

All taxiways are at least 50 feet wide and can further vary in width up to

100 feet wide, depending on which runway they are primarily serving. For example, Taxiway E extends from the east ramp to the west ramp crossing all three runways. Because each runway is designed to accommodate a different class of aircraft, the width of Taxiway E changes from 50 feet on the east, to 75 feet in the center, to 100 feet on the west.

Taxiway A is the east side full-length parallel taxiway to Runway 17-35. The portion of Taxiway A from the intersection with Taxiway K to the north is 50 feet wide, while the southern portion is 75 feet wide. Taxiway A provides access to the east ramp, also known as the general aviation ramp, which primarily serves general aviation activity. Taxiways E, K, and N provide access from Taxiway A to the east ramp.

Taxiway D is the east side full-length parallel taxiway to Runway 18-36. Taxiway D has a continual width of 75 feet and intersects with Runway 14-32 near the mid-point. The Nebraska Air National Guard apron and the Nebraska Army National Guard apron are accessible via Taxiway D. Taxiway G is a full-length parallel taxiway serving the west side of Runway 18-36. Taxiway G has a continual width of 75 feet and provides access to the west apron area.

Runway 14-32 is served by Taxiway J, a full-length parallel taxiway to the southwest side of the runway. Taxiway J has a continual width of 75 feet and provides access to the air carrier apron and terminal.

Taxiway B is located between the Runway 18 threshold and Runway 14-32. Taxiway K extends from the east ramp to Runway 14-32 and westward to intersect with Taxiway D and Runway 18-36. Taxiway S provides access from the west ramp to the mid-point of Runway 18-36.

HOLD APRONS

Hold aprons are designated areas on the airfield typically located at the end of taxiways near the runway end thresholds. The ATCT will instruct pilots to stop their aircraft on the hold apron until it is safe for the aircraft to proceed to the runway for take-off. Pilots may also utilize hold aprons, with authorization from the ATCT, for final pre-flight checks.

There are four designated hold aprons on the airfield. The hold apron on the north end of Taxiway A is able to accommodate a number of aircraft at the same time as it is approximately 4,827 square yards. The hold apron at the south end of Taxiway A is approximately 6,385 square yards in size and is also capable of accommodating a number of aircraft at the same time. It should be noted that the south hold apron is in the approach path and RSA serving Runway 32 and thus could not be utilized while operations are being conducted to Runway 14-32.

A run-up/hold apron is located on Taxiway E between Runway 18-36 and the west ramp and encompasses approximately 1,283 square yards. This is where large jet run-up activity will typically take place. The last hold

apron is located at the south end of Taxiway G. This apron provides approximately 1,166 square yards of pavement.

PAVEMENT MARKINGS

Pavement markings aid in the movement of aircraft along airport surfaces and identify closed or hazardous areas on the airport. The precision runway markings on Runway 18-36 identify the runway centerline, threshold, designation, touchdown point, and aircraft holding positions. Runways 14-32 and 17-35 are equipped with non-precision runway markings which identify the runway centerline, threshold, designation, and aircraft holding positions. The displaced thresholds on both ends of Runway 14-32 are marked by arrows. The Runway 18-36 and Runway 14-32 overruns are marked with chevrons.

Taxiway centerline markings are provided to assist pilots in maintaining proper clearance from pavement edges and objects near the taxiway/taxilane edges. Taxiway markings also include aircraft holding positions. The west edge of the general aviation ramp is marked with a centerline to prevent aircraft from missing their intended taxiway.

AIRFIELD LIGHTING

Airfield lighting systems extend an airport's usefulness into periods of darkness and/or poor visibility. A variety of lighting systems are installed at the airport for this purpose. These

lighting systems, categorized by function, are summarized as follows. All runways are available for nighttime operations.

Identification Lighting: The location of the airport at night is universally identified by a rotating beacon. The rotating beacon projects two beams of light, one white and one green, 180 degrees apart. The rotating beacon at Lincoln Airport is located on the west side of the airport, adjacent to the airport's large equipment storage facility.

Runway and Taxiway Lighting/Signage: Runway and taxiway edge lighting utilizes light fixtures placed near the edge of the pavement to define the lateral limits of the pavement. This lighting is essential for safe operations during night and/or times of low visibility in order to maintain safe and efficient access to and from the runways and aircraft parking areas.

Runways 18-36 and 17-35 are equipped with high intensity runway lights (HIRL). Runway 14-32 is served by medium intensity runway lights (MIRL). All taxiways are equipped with medium intensity taxiway edge lighting (MITL). Aprons and apron edge taxilanes have no edge lighting.

The airport also has a runway/taxiway signage system. The presence of runway/taxiway signage is an essential component of a surface movement guidance control system necessary for the safe and efficient operation of the airport. The signage system installed

at the Lincoln Airport includes runway and taxiway designations, holding positions, instrument landing system (ILS) critical areas, routing/directional, runway end and exits, and runway distance remaining.

Visual Approach Lighting: A four-light visual approach slope indicator (VASI) is located on the left side of each end of Runway 14-32. The VASI consists of two forward and two rear lighting units that alert approaching pilots of their position relative to the desired three-degree glide slope.

Runways 18-36 and 17-35 are served by the more advanced precision approach path indicator (PAPI) system, located to the left side of each runway end. These four-box units support a three-degree glide slope. When the system of red and green lights is interpreted by the pilot, they are given an indication of being above, below, or on the designated descent path to the runway threshold. A PAPI system has a range of five miles during the day and up to twenty miles at night.

Runway End Identification Lighting: Runway end identification lights (REILs) provide rapid and positive identification of the approach ends of a runway. A REIL system has been installed on the end of Runways 14 and 17. A REIL consists of two synchronized flashing lights, located laterally on each side of the runway end, facing the approaching aircraft.

Approach Lighting Systems: Approach lighting systems (ALS) are used in the approaches to runways as adjuncts to electronic navigational

aids for the final portion of IFR approaches and visual guides for night-time approaches under VFR conditions. The approach lighting system provides the pilot with visual cues concerning aircraft alignment, roll, height, and position relative to the threshold. The instrument landing system (ILS) approaches to Runways 18-36 are enhanced with the medium intensity approach lighting system with runway end alignment lights (MALSR).

Runway 35 is equipped with an omnidirectional approach lighting system (ODALS). This system provides circle guidance and visual identification of the approach end of the runway for landing aircraft and further enhances the operational safety of the airport. The 360 degree horizontal beam pattern, bright flashes of light, and the five-light sequential flash pattern aid the pilot in identifying the runway in use. The system consists of seven omnidirectional flashing light assemblies.

After-Hours Lighting: When the ATCT is closed, the MIRL on Runway 14-32 is preset to low intensity. The HIRL on Runways 18-36 and 17-35 are preset to medium intensity. The ODALS serving Runway 35 is continuously set to medium intensity. The MALSR lights serving Runway 18 and 36, as well as the REILs serving Runways 14 and 17, operate continuously on low intensity. All VASIs and PAPIs are on continuously.

WEATHER AND COMMUNICATION AIDS

The Lincoln Airport is equipped with five lighted wind cones. The wind cones provide information to pilots regarding wind conditions, such as direction and intensity. Two of the wind cones serve the east ramp area. One is located to the north between Runway 17-35 and Taxiway A, and the second is approximately 450 feet north of Taxiway N. A third lighted wind cone is located near the glide slope antennae serving Runway 18. The fourth wind cone is located to the side of the approach to Runway 14. The fifth wind cone is located between Taxiway G and the Runway 36 threshold.

The Lincoln Airport is equipped with an Automated Terminal Information Service (ATIS). ATIS broadcasts are updated hourly and provide arriving and departing pilots the current surface weather conditions, communication frequencies, and other important airport-specific information. The ATIS frequency at Lincoln Airport is 118.05 MHz.

The Lincoln Airport has access to the common advisory traffic frequency (CTAF). This radio frequency (118.5 MHz.) is used by pilots in the vicinity of the airport to communicate with each other about approaches to or departures from the airport when the airport traffic control tower is closed. In addition, a UNICOM frequency is

also available (122.95 MHz.), where a pilot can obtain information pertaining to the airport.

The Lincoln Airport is equipped with an Automated Surface Observing System (ASOS). An ASOS will automatically record weather conditions such as temperature, dew point, wind speed, altimeter setting, visibility, sky condition, and precipitation. The ASOS updates observations each minute 24 hours a day, and this information is transmitted to pilots in the airport vicinity via FAA VHF ground-to-air radio. Pilots can receive these broadcasts on the ATIS frequency or via a local telephone number (402.474.9214), where a computer-generated voice will present airport weather information. The airport is also equipped with a low level wind shear alert system (LLWAS). The LLWAS is designed to identify significant changes in wind patterns at low altitudes surrounding the airport and alert aircraft of the potential danger.

AREA AIRSPACE AND AIR TRAFFIC CONTROL

The *Federal Aviation Administration (FAA) Act of 1958* established the FAA as the responsible agency for the control and use of navigable airspace within the United States. The FAA has established the National Airspace System (NAS) to protect persons and property on the ground and to establish a safe and efficient airspace environment for civil, commercial, and military aviation. The NAS covers the common network of U.S. airspace, in-

cluding: air navigation facilities; airports and landing areas; aeronautical charts; associated rules, regulations, and procedures; technical information; and personnel and material. The system also includes components shared jointly with the military.

AIRSPACE STRUCTURE

Airspace within the United States is broadly classified as either “controlled” or “uncontrolled.” The difference between controlled and uncontrolled airspace relates primarily to requirements for pilot qualifications, ground-to-air communications, navigation and air traffic services, and weather conditions. Six classes of airspace have been designated in the United States, as shown on **Exhibit 1C**. Airspace designated as Class A, B, C, D, or E is considered controlled airspace. Aircraft operating within controlled airspace are subject to varying requirements for positive air traffic control. Airspace in the vicinity of Lincoln Airport is depicted on **Exhibit 1D**.

Class A Airspace: Class A airspace includes all airspace from 18,000 feet mean sea level (MSL) to flight level (FL) 600 (60,000 feet MSL). This airspace is designated in Federal Aviation Regulation (F.A.R.) Part 71.193, for positive control of aircraft. The Positive Control Area (PCA) allows flights governed only under IFR operations. The aircraft must have special radio and navigation equipment, and the pilot must obtain clearance from an air traffic control (ATC) facility to enter Class A airspace. In addi-

tion, the pilot must possess an instrument rating.

Class B Airspace: Class B airspace has been designated around some of the country's busiest commercial service airports, such as the Kansas City International Airport. Class B airspace is designed to regulate the flow of uncontrolled traffic, above, around, and below the arrival and departure airspace required for high-performance, passenger-carrying aircraft at busy commercial service airports. This airspace is the most-restrictive controlled airspace encountered by pilots operating under visual flight rules (VFR). There is no Class B airspace in the immediate vicinity of Lincoln Airport.

In order to fly within Class B airspace, an aircraft must be equipped with special radio and navigation equipment and must obtain clearance from air traffic control. Moreover, a pilot must have at least a private pilot's certificate or be a student pilot who has met the requirements of F.A.R. Part 61.95, which requires special ground and flight training for the Class B airspace. Helicopters do not need special navigation equipment or a transponder if they operate at or below 1,000 feet and have made prior arrangements in the form of a Letter of Agreement with the FAA controlling agency. Aircraft are also required to have and utilize a Mode C transponder within a 30-nautical-mile (NM) range of the center of the Class B airspace. A Mode C transponder allows the ATCT to track the altitude of the aircraft.

Class C Airspace: The FAA has established Class C airspace at 120 airports around the country, as a means of regulating air traffic in these areas. Class C airspace is designed to regulate the flow of uncontrolled traffic above, around, and below the arrival and departure airspace required for high-performance, passenger-carrying aircraft at some commercial service airports. In order to fly inside Class C airspace, the aircraft must have a two-way radio, an encoding transponder, and have established communication with ATC. Aircraft may fly below the floor of the Class C airspace, or above the Class C airspace ceiling without establishing communication with ATC. Lincoln Airport is supported by Class C airspace.

Exhibit 1D shows the Lincoln Airport Class C airspace. The Class C airspace consists of controlled airspace extending upward from the surface to 5,200 feet MSL. The inner cylinder of the airspace has a radius of five nautical miles and extends from the surface of the airport up to 5,200 feet MSL. The outer cylinder extends from the inner ring to a radius of ten nautical miles and with designated controlled airspace between 2,700 MSL to a ceiling of 5,200 feet MSL.

Class D Airspace: Class D airspace is controlled airspace surrounding airports with an ATCT. The Class D airspace typically constitutes a cylinder with a horizontal radius of four or five NM from the airport, extending from the surface up to a designated vertical limit, typically set at approximately 2,500 feet above the airport elevation.

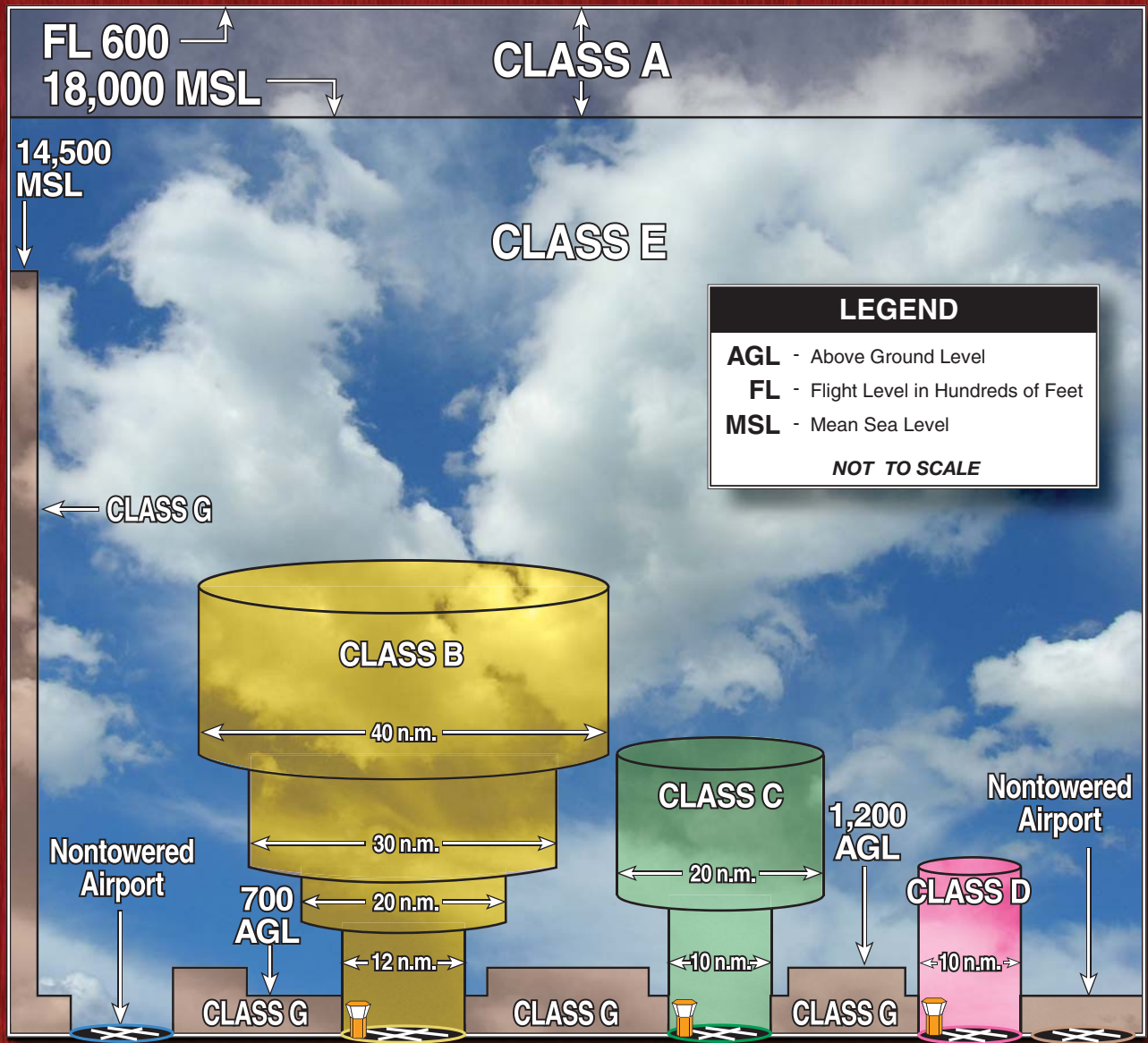

LEGEND

AGL - Above Ground Level
FL - Flight Level in Hundreds of Feet
MSL - Mean Sea Level

NOT TO SCALE

| CLASSIFICATION | DEFINITION |
|----------------|--|
| CLASS A | Generally airspace above 18,000 feet MSL up to and including FL 600. |
| CLASS B | Generally multi-layered airspace from the surface up to 10,000 feet MSL surrounding the nation's busiest airports. |
| CLASS C | Generally airspace from the surface to 4,000 feet AGL surrounding towered airports with service by radar approach control. |
| CLASS D | Generally airspace from the surface to 2,500 feet AGL surrounding towered airports. |
| CLASS E | Generally controlled airspace that is not Class A, Class B, Class C, or Class D. |
| CLASS G | Generally uncontrolled airspace that is not Class A, Class B, Class C, Class D, or Class E. |

Source: "Airspace Reclassification and Charting Changes for VFR Products," National Oceanic and Atmospheric Administration, National Ocean Service. Chart adapted by Coffman Associates from AOPA Pilot, January 1993.

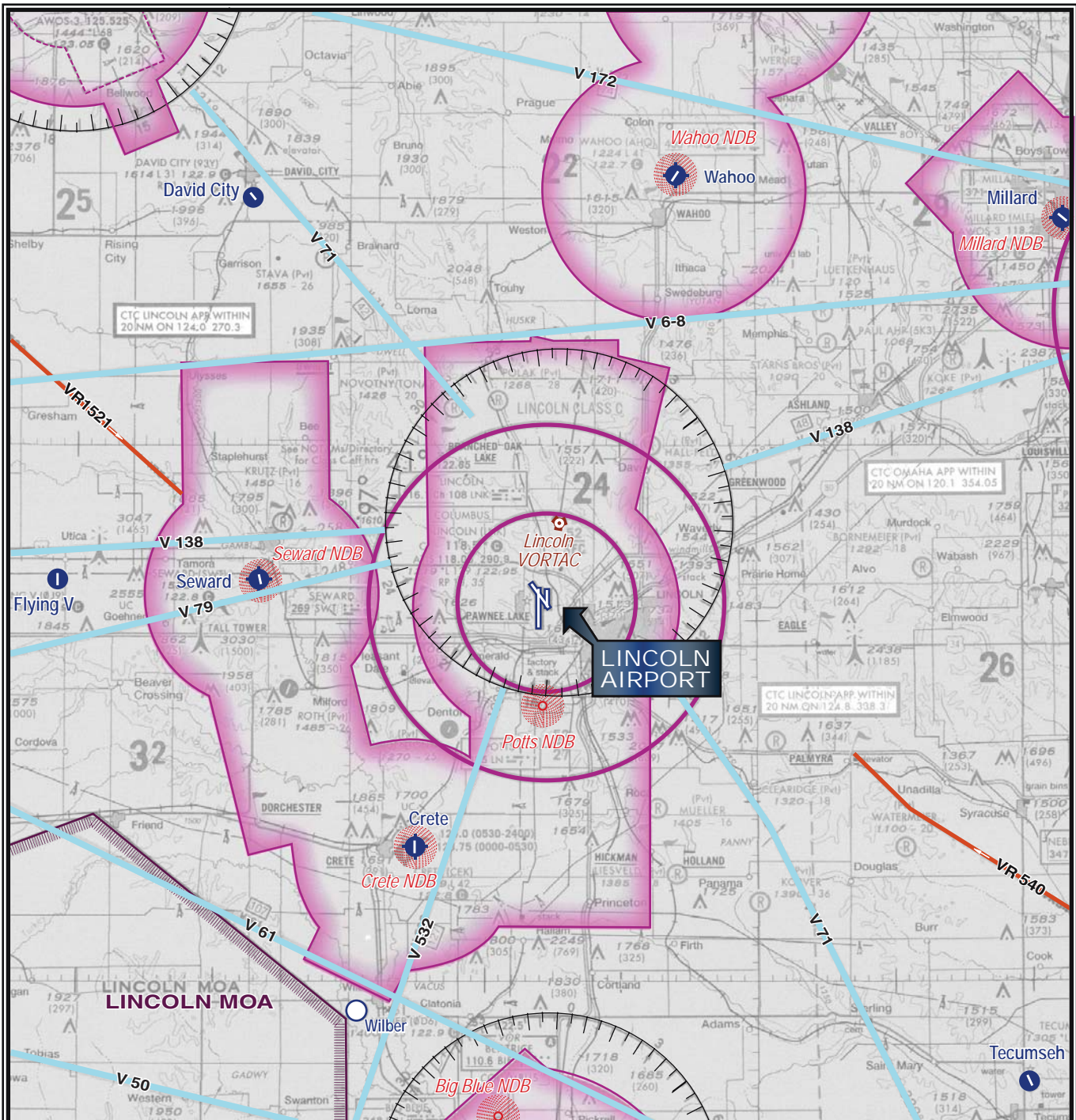

LEGEND

- | | | | |
|--|---|--|--|
| | Airport with other than hard-surfaced runways | | Compass Rose |
| | Airport with hard-surfaced runways 1,500' to 8,069' in length | | Class C Airspace |
| | Airports with hard-surfaced runways greater than 8,069' or some multiple runways less than 8,069' | | Class E Airspace with Floor 700 ft. or greater above surface |
| | VORTAC | | Military Training Routes |
| | Non-Directional Radiobeacon (NDB) | | Victor Airways |
| | | | MOA - Military Operations Area |
| | | | Class E Airspace with floor 700 ft. above surface |

Source: Omaha Sectional Chart, US Department of Commerce, National Oceanic and Atmospheric Administration 6/08/06

If an airport has an instrument approach or departure, the Class D airspace sometimes extends along the approach or departure path. There are no airports with designated Class D airspace in the vicinity of Lincoln Airport.

Class E Airspace: Class E airspace consists of controlled airspace designed to contain IFR operations near an airport, and while aircraft are transitioning between the airport and enroute environments. Unless otherwise specified, Class E airspace terminates at the base of the overlying airspace. Only aircraft operating under IFR are required to be in contact with air traffic control when operating in Class E airspace. While aircraft conducting visual flights in Class E airspace are not required to be in radio communications with air traffic control facilities, visual flight can only be conducted if minimum visibility and cloud ceilings exist. There are several airports supported by Class E airspace in the vicinity of Lincoln Airport.

Class G Airspace: Airspace not designated as Class A, B, C, D, or E is considered uncontrolled, or Class G airspace. Air traffic control does not have the authority or responsibility to exercise control over air traffic within this airspace. Class G airspace lies between the surface and the overlying Class E airspace (700 to 1,200 feet above ground level [AGL]). Class G airspace extends below the floor of the Class E airspace at Lincoln Airport.

SPECIAL USE AIRSPACE

Special use airspace is defined as airspace where activities must be confined because of their nature or where limitations are imposed on aircraft not taking part in those activities. These areas are depicted on **Exhibit 1D** by purple-hatched lines.

Military Operating Areas: Military Operations Areas (MOAs) are depicted in **Exhibit 1D** with the purple-hatched lines. The MOA in the vicinity of Lincoln Airport is the Lincoln MOA to the southwest. This MOA is relatively distant from Lincoln Airport and has little effect on air traffic in the Lincoln Airport area.

Military Training Routes: Military training routes (MTR) are designated airspace that has been generally established for use by high performance military aircraft to train below 10,000 feet AGL and in excess of 250 knots. There are VR (visual) and IR (instrument) designated MTRs. MTRs with no segment above 1,500 feet AGL will be designated with the "VR" or "IR," followed by a four digit number (e.g., VR1520, VR 1521). MTRs with one or more segments above 1,500 feet AGL are identified by the route designation followed by a three digit number (e.g., VR540). The arrows on the route show the direction of travel. There are several MTR in the vicinity of the Lincoln Airport.

Victor Airways: For aircraft arriving or departing the regional area using very high frequency omnidirectional range (VOR) facilities, a system of Federal Airways, referred to as Victor Airways, has been established. Victor Airways are corridors of airspace eight miles wide that extend upward from 1,200 feet AGL to 18,000 feet MSL and extend between VOR navigational facilities. Victor Airways are shown with solid blue lines on **Exhibit 1D**.

For aircraft enroute or departing the Lincoln area, there are several Victor Airways available. The Lincoln Airport VORTAC, located approximately four nautical miles (NM) north of the airport is the converging point for Victor Airways in the Lincoln area.

AIRSPACE CONTROL

The FAA has established 21 Air Route Traffic Control Centers (ARTCC) throughout the continental United States to control aircraft operating under IFR within controlled airspace and while enroute. An ARTCC assigns specific routes and altitudes along federal airways to maintain separation and orderly traffic flow. The Minneapolis Center controls enroute airspace in the Lincoln region.

The ARTCC delegates certain airspace to local terminal facilities which assume responsibility for the orderly flow of air traffic arriving and departing major terminals. Lincoln approach control is charged with radar approach and departure control in the terminal area. The approach control

is co-located in the ATCT at Lincoln Airport.

The Lincoln ATCT, approach, and departure control operate between the hours of 5:30 a.m. and 12:00 midnight. The Minneapolis ARTCC provides approach and departure control services when the Lincoln approach and departure control is closed. Flight plans can be opened or closed utilizing the Columbus Flight Service Station 24-hours a day through the ATCT or on a remote communications outlet (RCO) channel of 122.65 MHz.

NAVIGATIONAL AIDS

Navigational aids are electronic devices that transmit radio frequencies, which pilots of properly equipped aircraft can translate into point-to-point guidance and position information. The types of electronic navigational aids available for aircraft flying to or from Lincoln Airport include a non-directional beacon (NDB), a very high frequency omnidirectional range (VOR) facility, LORAN-C, and the global positioning system (GPS). All navigational aids at the airport are owned and maintained by the FAA.

The NDB transmits nondirectional radio signals whereby the pilot of an aircraft, equipped with direction-finding equipment, can determine their bearing to or from the NDB facility in order to track to the beacon station. Four NDB facilities are located near Lincoln Airport. The Potts NDB is six miles to the southwest, the Seward NDB is approximately 16 miles to the west, the Wahoo NDB is approxi-

mately 24 miles to the northeast, and the Big Blue NDB is 29 miles to the south.

The VOR, in general, provides azimuth readings to pilots of properly equipped aircraft transmitting a radio signal at every degree to provide 360 individual navigational courses. Frequently, distance measuring equipment (DME) is combined with a VOR facility (VOR-DME) to provide distance as well as direction information to the pilot. Military tactical air navigation aids (TACANs) and civil VORs are commonly combined to form a VORTAC. The VORTAC provides distance and direction information to both civil and military pilots. The Lincoln VORTAC is located approximately four miles to the north of the airport.

GPS is an additional navigational aid for pilots. GPS was initially developed by the United States Department of Defense for military navigation around the world. GPS differs from a NDB or VOR, in that pilots are not required to navigate using a specific facility. GPS uses satellites placed in orbit around the earth to transmit electronic radio signals, which pilots of properly equipped aircraft use to determine altitude, speed, and other navigational information. With GPS, pilots can directly navigate to any airport in the country and are not required to navigate using a specific navigation facility.

LORAN-C is a radio navigation system originally developed by the U.S. Coast Guard for maritime navigation. The system was expanded to include

24 ground-based stations across the continental United States. LORAN-C provides navigation, location, and timing services to both civil and military air, land, and marine users. The system is approved as an en-route supplemental air navigation system for both IFR and VFR operations.

With the advancements taking place with the GPS system, the need for the older LORAN-C facilities is being evaluated by the FAA. Although there are no short-term plans to close the LORAN-C system, in the long-term, the system may be replaced by GPS.

Many commercial service airports are equipped with an Instrument Landing System (ILS). The ILS is comprised of a localizer antenna, a glideslope antenna, and a medium intensity approach lighting system with runway alignment indicator lights. Approaches utilizing the ILS can be completed when cloud ceilings are as low as 200 feet and visibility is down to one-half mile. Both Runways 18 and 36 at Lincoln Airport are equipped with ILS approaches.

INSTRUMENT APPROACH PROCEDURES

Instrument approach procedures are a series of predetermined maneuvers established by the FAA, using electronic navigational aids that assist pilots in locating and landing at an airport, especially during instrument flight conditions. There are currently four published precision instrument approaches and eight published non-precision instrument approaches into

Lincoln Airport. Precision instrument approaches provide vertical descent information and course guidance information to the pilot. Non-precision approaches only provide course guidance to the pilot.

The capability of an instrument is defined by the visibility and cloud ceiling minimums associated with the approach. Visibility minimums define the horizontal distance the pilot must be able to see in order to complete the

approach. Cloud ceilings define the lowest level a cloud layer (defined in feet above the ground) can be situated for the pilot to complete the approach. If the observed visibility or cloud ceilings are below the minimums prescribed for the approach, the pilot cannot complete the instrument approach. **Table 1J** summarizes FAA-approved instrument approach procedures and associated weather minima for Lincoln Airport.

| TABLE 1J Instrument Approach Data | | | | | | | | | | |
|--|--|------------|-------------------|------------|-------------------|------------|-------------------|------------|-------------------|------------|
| | WEATHER MINIMUMS BY AIRCRAFT TYPE | | | | | | | | | |
| | Category A | | Category B | | Category C | | Category D | | Category E | |
| | CH | VIS | CH | VIS | CH | VIS | CH | VIS | CH | VIS |
| HI-ILS RWY 18 | | | | | | | | | | |
| Straight-In ILS | N/A | N/A | N/A | N/A | 200 | 0.5 | 200 | 0.5 | 200 | 0.5 |
| Straight- In Localizer | N/A | N/A | N/A | N/A | 600 | 1.0 | 600 | 1.25 | 600 | 1.25 |
| Circling | N/A | N/A | N/A | N/A | 600 | 1.5 | 600 | 2.0 | 900 | 2.75 |
| HI-ILS RWY 36 | | | | | | | | | | |
| Straight-In ILS | N/A | N/A | N/A | N/A | 200 | 0.5 | 200 | 0.5 | 200 | 0.5 |
| Straight-In Localizer | N/A | N/A | N/A | N/A | 500 | 0.75 | 500 | 1.0 | 500 | 1.0 |
| Circling | N/A | N/A | N/A | N/A | 600 | 1.5 | 600 | 2.0 | 900 | 2.75 |
| ILS or LOC RWY 18 | | | | | | | | | | |
| Straight-In ILS | 200 | 0.5 | 200 | 0.5 | 200 | 0.5 | 200 | 0.5 | N/A | N/A |
| Straight- In Localizer | 600 | 0.5 | 600 | 0.5 | 600 | 1.0 | 600 | 1.25 | N/A | N/A |
| Circling | 600 | 1.0 | 600 | 1.0 | 600 | 1.5 | 600 | 2.0 | N/A | N/A |
| ILS RWY 36 | | | | | | | | | | |
| Straight-In ILS | 200 | 0.5 | 200 | 0.5 | 200 | 0.5 | 200 | 0.5 | N/A | N/A |
| Straight- In Localizer | 500 | 0.5 | 500 | 0.5 | 500 | 0.75 | 500 | 1.0 | N/A | N/A |
| Circling | 600 | 1.0 | 600 | 1.0 | 500 | 1.5 | 600 | 2.0 | N/A | N/A |
| HI-VOR/DME or TACAN RWY 18 | | | | | | | | | | |
| Straight-In | N/A | N/A | N/A | N/A | 600 | 1.5 | 600 | 1.75 | 600 | 1.75 |
| Circling | N/A | N/A | N/A | N/A | 600 | 1.5 | 600 | 2.0 | 900 | 2.75 |
| HI-VOR/DME or TACAN RWY 36 | | | | | | | | | | |
| Straight-In | N/A | N/A | N/A | N/A | 600 | 1.0 | 600 | 1.0 | 600 | 1.25 |
| Circling | N/A | N/A | N/A | N/A | 600 | 1.5 | 600 | 2.0 | 900 | 2.75 |
| RNAV (GPS) RWY 14 | | | | | | | | | | |
| LNAV MDA | 400 | 1.0 | 400 | 1.0 | 400 | 1.25 | 400 | 1.25 | N/A | N/A |
| Circling | 600 | 1.0 | 600 | 1.0 | 600 | 1.5 | 600 | 2.0 | N/A | N/A |
| RNAV (GPS) RWY 18 | | | | | | | | | | |
| LPV DA | 300 | 0.5 | 300 | 0.5 | 300 | 0.5 | 300 | 0.5 | N/A | N/A |
| LNAV/VNAV DA | 400 | 1.0 | 400 | 1.0 | 400 | 1.0 | 400 | 1.0 | N/A | N/A |
| LNAV MDA | 400 | 0.5 | 400 | 0.5 | 400 | 0.5 | 400 | 1.0 | N/A | N/A |
| Circling | 600 | 1.5 | 600 | 1.5 | 600 | 1.5 | 700 | 2.0 | N/A | N/A |

| TABLE 1J (Continued) | | | | | | | | | | |
|--|--|------------|-------------------|------------|-------------------|------------|-------------------|------------|-------------------|------------|
| Instrument Approach Data | | | | | | | | | | |
| | WEATHER MINIMUMS BY AIRCRAFT TYPE | | | | | | | | | |
| | Category A | | Category B | | Category C | | Category D | | Category E | |
| | CH | VIS | CH | VIS | CH | VIS | CH | VIS | CH | VIS |
| RNAV (GPS) RWY 36 | | | | | | | | | | |
| LPV DA | 300 | 0.5 | 300 | 0.5 | 300 | 0.5 | 300 | 0.5 | N/A | N/A |
| LNAV/VNAV DA | 500 | 1.25 | 500 | 1.25 | 500 | 1.25 | 500 | 1.25 | N/A | N/A |
| LNAV MDA | 500 | 0.5 | 500 | 0.5 | 500 | 0.75 | 500 | 1.0 | N/A | N/A |
| Circling | 600 | 1.75 | 600 | 1.75 | 600 | 1.75 | 700 | 2.0 | N/A | N/A |
| VOR or GPS RWY 17 | | | | | | | | | | |
| Straight-In | 600 | 1.0 | 600 | 1.0 | 600 | 1.5 | 600 | 1.5 | N/A | N/A |
| Circling | 600 | 1.0 | 600 | 1.0 | 600 | 1.5 | 600 | 2.0 | N/A | N/A |
| VOR RWY 18 | | | | | | | | | | |
| Straight-In | 600 | 1.0 | 600 | 1.0 | 600 | 1.5 | 600 | 1.75 | N/A | N/A |
| Circling | 600 | 1.0 | 600 | 1.0 | 600 | 1.5 | 600 | 2.0 | N/A | N/A |
| NDB RWY 36* | | | | | | | | | | |
| Straight-In | 600 | 0.75 | 600 | 0.75 | 600 | 1.0 | 600 | 1.5 | N/A | N/A |
| Circling | 600 | 1.0 | 600 | 1.0 | 600 | 1.5 | 700 | 2.0 | N/A | N/A |
| <p>Aircraft categories are based on the approach speed of aircraft, which is determined by 1.3 times the stall speed in landing configuration. The approach categories are as follows:</p> <p>Category A 0-90 knots (Cessna 172)</p> <p>Category B 91-120 knots (Beechcraft KingAir)</p> <p>Category C 121-140 knots (Canadair Challenger)</p> <p>Category D 141-165 knots (Gulfstream IV)</p> <p>Category E Speed greater than 166 knots (F-16)</p> <p>Abbreviations:</p> <p>CH: Cloud Height (in feet above ground level)</p> <p>DA: Decision Altitude</p> <p>GPS: Global Positioning System</p> <p>HI-ILS: High Altitude Instrument Landing System</p> <p>ILS: Instrument Landing System</p> <p>LNAV: Lateral Navigation</p> <p>LOC: Localizer</p> <p>LPV: Lateral Precision with Vertical Guidance</p> <p>MDA: Minimum Descent Altitude</p> <p>N/A: Not Available</p> <p>RNAV: Area Navigation</p> <p>TACAN: Tactical Air Navigation</p> <p>VNAV: Vertical Navigation</p> <p>VIS: Visibility (in statute miles)</p> <p>* Valid until Potts NDB is decommissioned in 2008.</p> <p>Source: <i>U.S. Terminal Procedures, North Central, September 28, 2006</i></p> | | | | | | | | | | |

The FAA is continually updating approaches to airports. There are two approaches under development to the Lincoln Airport. The first is an adjustment to the ILS approach to Runway 18. The second is a new RNAV (GPS) approach to Runway 35. This

approach is planned to have a circling component to Runway 17 as well.

AIRPORT TRAFFIC PATTERN

While aircraft can be expected to operate over most areas of the region,

the density of aircraft operations is higher near the airport. This is the result of aircraft following the established traffic patterns for the airport. The traffic pattern is the traffic flow that is prescribed for aircraft landing or taking off from an airport.

Essentially, the traffic pattern defines which side of the runway aircraft will operate. For example, at Lincoln Airport, Runways 18 and 35 have an established non-standard right-hand traffic pattern. For these runways, aircraft make right turns throughout pattern operation. Therefore, aircraft operating to Runway 18 remain west of the runway and aircraft operating to Runway 35 remain east of the runway. When operating on Runways 36, 14, 32 or 17, aircraft make standard left-hand turns. This also allows aircraft to remain west of Runway 18-36, east of Runway 17-35, and on either side of Runway 14-32.

The FAA has established that aircraft operating in the traffic pattern fly at 1,000 feet AGL or 2,219 feet MSL. Heavy military jets are to operate at 1,781 feet AGL or 3,000 feet MSL. The traffic pattern altitude is established so that aircraft have a predictable descent profile on base leg to final for landing.

REGIONAL AIRPORTS

A review of public-use airports within the vicinity of Lincoln Airport has been made to identify and distinguish the type of air service provided in the

area surrounding the airport. Information pertaining to each airport was obtained from FAA records.

Crete Municipal Airport (CEK) is located approximately 16 nautical miles southwest of Lincoln Airport, and is owned by the City of Crete and operated by the Crete Airport Authority. The airport is served by two runways (one paved and one turf), with concrete Runway 17-35 providing the greatest length at 4,202 feet long by 75 feet wide. The airport has approximately 62 based aircraft and experiences approximately 24,000 annual operations. Avgas (100LL) and Jet A fuel are available at the airport.

Seward Municipal Airport (SWT) is located approximately 16 nautical miles to the west of Lincoln Airport. The airport is owned and operated by the Seward Airport Authority and is served by a paved and a turf runway. Constructed of concrete, Runway 16-34 is 4,200 feet long by 75 feet wide. The airport is home to 28 aircraft and experiences approximately 13,000 annual operations. Avgas and Jet A fuel are available at the airport.

Wahoo Municipal Airport (AHQ) is located approximately 25 nautical miles north of Lincoln Airport. The airport is owned by the Wahoo Airport Authority and provides a turf runway and a 4,101-foot-long by 75-foot-wide concrete runway. The airport is home to 51 aircraft and experiences approximately 16,000 annual operations. Avgas fuel is available at the airport.

LANDSIDE FACILITIES

Landside facilities are the facilities that support the aircraft and pilot/passenger handling functions. These facilities include the passenger terminal complex, cargo facilities, general aviation facilities, and support facilities such as fuel storage, automobile parking, roadway access, and aircraft rescue and firefighting. The landside facilities at Lincoln Airport are identified on **Exhibit 1E**.

PASSENGER TERMINAL BUILDING

The passenger terminal complex, which was constructed in 1974, is located in the central portion of the Lincoln Airport. Four jetways were installed in 2002 and are available for upper level gates 1, 2, 3, and 4, and provide all-weather loading and unloading of passengers. The jetways have the capability to serve two aircraft each. Security checkpoints are in place near the entrance to each gate area to ensure all passengers are screened prior to boarding aircraft.

As depicted on **Exhibit 1F**, airline ticket counters, rental car kiosks, baggage claim, travel agent booths, and lobby areas are located on the ground level of the terminal building. Flight information monitors near the entrance and lobby areas of the terminal building display flight information to all travelers. Employee offices and lounge areas are also located on the ground floor of the terminal building. Rental car companies currently serv-

ing Lincoln Airport include: Avis, Budget, Hertz, National/Alamo, and Thrifty. Enterprise also serves airport customers from an off-airport location. DashAbout Shuttle and Eppley Express provide van services to Lincoln Airport.

Located at the center of the terminal facility is a set of stairs and escalators which allow access to the second level of the terminal building. A set of elevators located behind the stairs and escalators is available for handicapped travelers. A vendor and the Lincoln Airport Authority offices are located on the second level, in addition to the security check points for the two gate holding areas. All departing passengers are loaded onto aircraft from the second level gate area. Renovations carried out in 2003 to the second level of the terminal building include improvements to the gift shop and enlargement of the food court area.

Arriving passengers deplane aircraft at the second level gates and proceed to the ground floor for baggage claim and to egress to landside transportation. Two baggage claim carousels are available in the central portion of the terminal.

The terminal area is accessible via West Adams Street, which provides one-way traffic flow to the terminal building and parking lots. The west lane of the roadway provides access to the parking garage and surface parking lots. The access roadway expands from two lanes to five as it approaches the terminal building. Private automobiles use the two lanes adjacent to

the terminal for loading and unloading. The outside lane (west) is a commercial lane used by taxi cabs, charter buses, and shuttle buses. The middle two lanes are for through traffic. Rental car ready and return parking is located on the first floor of the parking garage. The roadway then circles west around the parking facility, providing exit avenues from these facilities.

AUTOMOBILE PARKING

Vehicle parking for the passenger terminal complex includes public, employee, and rental car space. The public vehicle parking garage is located just west of the terminal building and provides 491 spaces. The rental car agencies lease approximately 124 spaces in the parking garage. The garage is elevator-equipped and is connected to the second level of the terminal building by an enclosed pedestrian bridge.

There is a surface parking lot to the immediate north of the terminal building utilized for rental car return/return. This lot provides 60 parking spaces and is primarily utilized as overflow parking by the rental car agencies. A lot to the south of the terminal building provides an additional 51 spaces utilized by those working in the terminal building.

The surface parking lot immediately to the north of the parking garage is utilized for long term parking. A total of 189 spaces are available in this lot. To the south of the parking garage is

the short term surface parking lot with 113 spaces available. To the south of the short term lot is the long term lot, with 537 spaces available. The last four rows of the long term lot provide 87 parking spaces designated for employees. An overflow parking lot with 540 spaces is located east of the NEANG base.

Rental Cars: Lincoln Airport is served by Avis, Budget, Hertz, National/Alamo, and Thrifty rental car businesses. A total of 124 rental car ready/return spaces are in the first floor of the parking garage. Ready and return lots are available to the north and south of the terminal building. Avis and Hertz currently utilize the north lot while Budget, National, and Thrifty utilize the south parking lot. A common rental car service facility was constructed in 2001. This facility provides a location for the rental car businesses to service their vehicles and prepare them for customers. This facility is located south of West Adams Street and east of the Nebraska Air National Guard facilities and is accessible via North Park Road.

TERMINAL AIRCRAFT APRON

The adjacent apron to the terminal building encompasses approximately 89,000 square yards, providing space for commercial aircraft to park, deplane and board passengers. Four jetways extend from the terminal building onto the apron allowing for covered access to the aircraft from the terminal building.



LEGEND

- - - Airport Property Line
- - - Ultimate Property Line
- T-Hangars
- Box Hangars

SECOND FLOOR PLAN

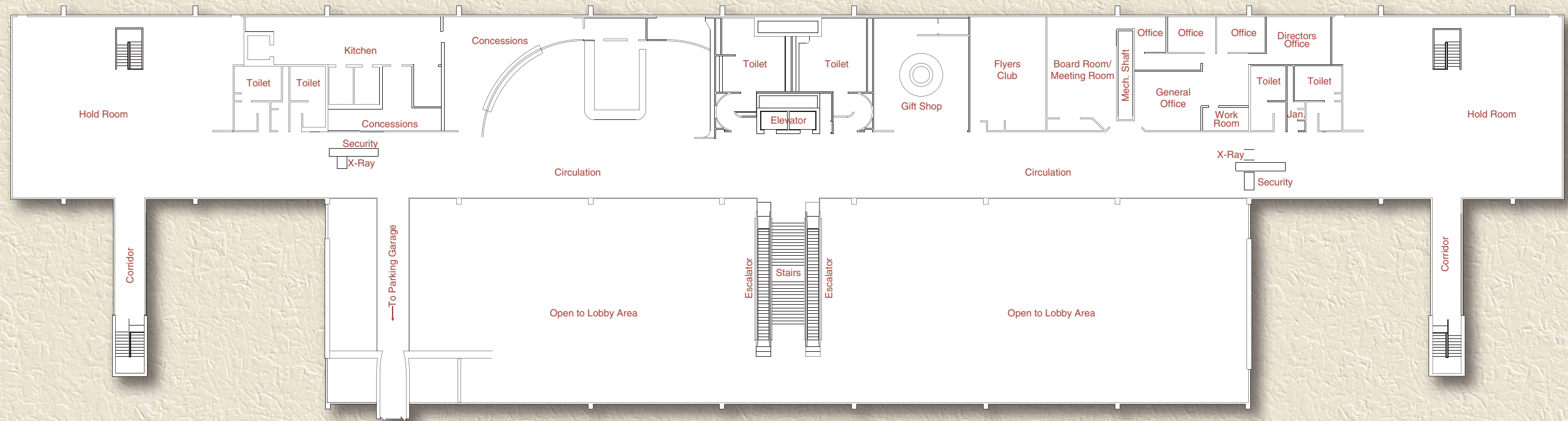

FIRST FLOOR PLAN

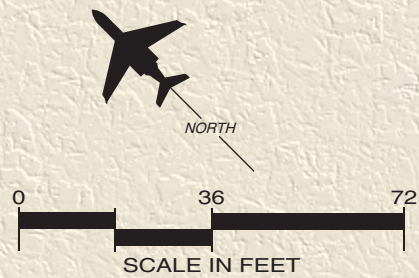
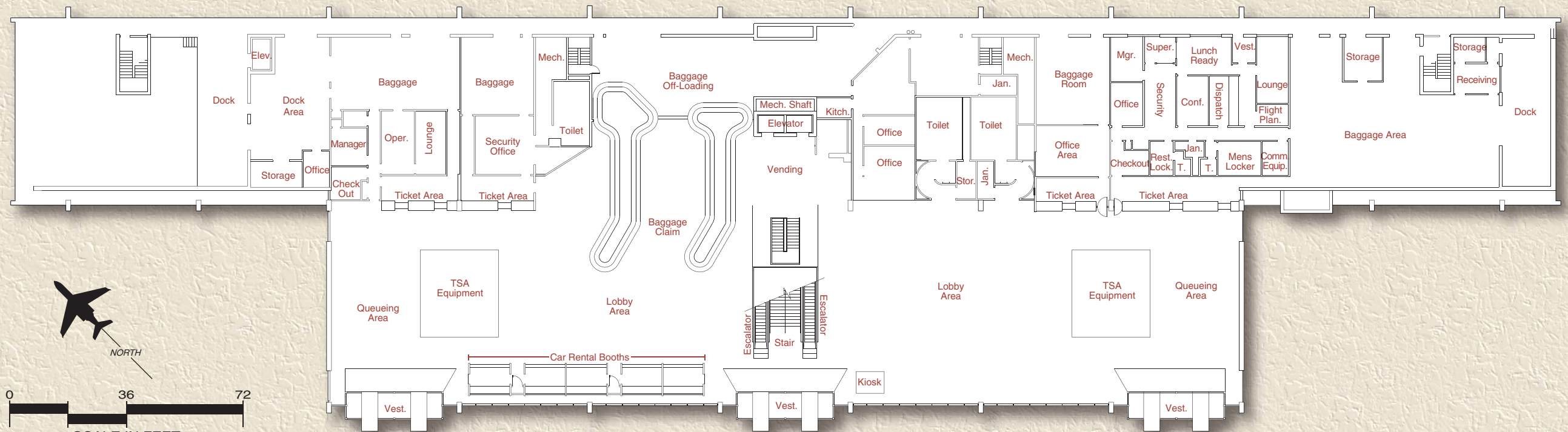

AIR CARGO FACILITIES

The air cargo facilities have not been altered since the previous master plan. As shown on **Exhibit 1E**, the cargo facilities are located southeast of the passenger terminal complex, with landside access provided from West Adams Street. The air cargo building has a total area of 21,290 square feet and is accessed on the airside from the terminal complex apron. Auto parking and loading docks are provided on the landside of the buildings.

FIXED BASE OPERATOR (FBO) AND SPECIALTY OPERATORS

Lincoln Airport currently has two full-service fixed base operators – Duncan Aviation and Silverhawk Jet Center, and one specialty operator – Hillaero Modification. The following is a list of services provided by each FBO.

Duncan Aviation

- Aviation Fuel (100LL and Jet A)
- Pilot Services
- Oxygen Service
- Charter Operations
- Passenger Terminal and Lounge
- Weather Briefing Equipment
- Aircraft Tie-downs
- Airframe and Engine Maintenance
- Avionics Repair/Installations
- Instrument Repair/Overhaul
- Aircraft Sales

Duncan Aviation occupies nine hangars encompassing approximately 205,700 square feet located on the southern portion of the general aviation ramp. In addition, Duncan has

approximately 67,600 square feet of office space. Duncan Aviation currently employs approximately 1,100 people at the Lincoln facility, making them one of the largest employers in the Lincoln metropolitan area. This operator currently bases four Lear jet aircraft, two Cessna Citation 650s, one Pilatus, and two Beechcraft Bonanzas at the airport.

Silverhawk Jet Center

- Aviation Fuel (100LL and Jet A)
- Flight Training
- Aircraft Rental
- Aircraft Maintenance
- Aircraft Management
- Charter Operations
- Pilot Services
- Avionics Maintenance

Silverhawk Jet Center is located in two hangars encompassing 26,000 square-feet on the general aviation ramp to the north of the main Duncan Aviation facilities. Silverhawk Jet Center currently employs approximately 35 people and owns three charter planes including a Cheyenne, King Air, and a Cessna Citation CJ2. Silverhawk Jet Center also conducts flight training operations on a contract basis.

Hillaero Modification Center

- Exteriors (Paint Schemes and Procedures)
- Interiors (Custom Cabinets, Composite Panels, Replacement Tables)
- Aeromed Conversions
- Avionics

Hillaero is a specialty operator located on the general aviation ramp with the

Silverhawk hangar to the north and Duncan Aviation to the south. They occupy a 22,000 square-foot hangar in this location. Hillaero specializes in exterior painting, interior upholstery and carpentry. Overall aircraft refurbishment is their specialty. Through agreement with Silverhawk Jet Center, Hillaero offers avionics maintenance and upgrades.

GENERAL AVIATION HANGARS

There are 38 separate hangar buildings encompassing approximately 648,000 square feet at Lincoln Airport. The hangars include T-hangars, corporate hangars, and larger conventional hangars occupied by the FBOs. T-hangars provide for separate, single-aircraft storage areas in a long, narrow building. Corporate hangars provide a larger enclosed space, accommodating larger multi-engine piston or turbine aircraft. The conventional hangars used by the FBOs provide a large enclosed space, typically accommodating more than one aircraft.

There are 19 T-hangar buildings on the airport, providing approximately 226,000 square feet of aircraft storage space. All T-hangar buildings are located on the east side of the airport in the general aviation area.

There are ten separate executive hangar structures at the Lincoln Airport encompassing a total of approximately 113,000 square feet. Each of these corporate hangars is located on the eastern general aviation side of the airport.

There are eight larger conventional hangars used by the FBOs, which encompass a total of approximately 245,000 square feet. These large hangars are used for various services such as aircraft storage, maintenance services, office space, and pilot services. Each of the conventional hangars are located adjacent the general aviation apron on the east side of the airport.

A large automobile parking lot is available for Duncan Aviation employees. A smaller lot adjacent to Silverhawk provides space for T-hangar users as well as other visitors to the general aviation area. The larger FBO conventional hangars have parking lots located adjacent to each building. These lots and hangar facilities are accessible via Aviation Road and North Park Road which intersect with West Adams Street to the south.

SUPPORT FACILITIES

Several support facilities serve as critical links in providing the necessary efficiency to aircraft ground operations such as aircraft rescue and firefighting (ARFF), airport maintenance, and fuel storage.

Part 139 Certification

Federal Aviation Regulations (FAR) Part 139 prescribes rules governing the certification and operation of land airports that serve any scheduled or unscheduled passenger operation that is conducted with an aircraft having a seating capacity of more than nine passengers.

Under this certification, airports are classified based on the type of air carrier operations served:

- **Class I Airport** – an airport certificated to serve scheduled operations of large air carrier aircraft that can also serve unscheduled passenger operations of large air carrier aircraft and/or scheduled operations of small air carrier aircraft. Lincoln Airport is a Class I airport.
- **Class II Airport** – an airport certificated to serve scheduled operations of small air carrier aircraft and the unscheduled passenger operations of large air carrier aircraft. A Class II airport cannot serve scheduled large air carrier aircraft.
- **Class III Airport** – an airport certificated to serve scheduled operations of small air carrier aircraft. A Class III airport cannot serve scheduled or unscheduled large air carrier aircraft.
- **Class IV Airport** – an airport certificated to serve unscheduled passenger operations of large air carrier aircraft. A Class IV airport cannot serve scheduled large or small air carrier aircraft.

Aircraft Rescue and Firefighting Facilities (ARFF)

Part 139 airports are required to provide aircraft rescue and fire fighting (ARFF) services during air carrier op-

erations. Each certificated airport maintains equipment and personnel based on an ARFF index established according to the length of aircraft and scheduled daily flight frequency. There are five indices, A through E, with A applicable to the smallest aircraft and E the largest (based on wingspan). Lincoln Airport falls within ARFF index B. As such, Lincoln Airport is required to maintain a fleet of equipment and properly trained personnel consistent with this standard.

The Lincoln Airport ARFF facility is centrally located on the airfield at the north end of the Nebraska Air National Guard (NEANG) ramp. This 13,667 square foot facility is owned by NEANG and rests on land leased from the Lincoln Airport Authority. The ARFF facility houses the following equipment:

- Two Teledyne-Continental P-23 Airport Fire Trucks with:
 - 3,300 gallons of water
 - 500 gallons of aqueous fire fighting foam
 - 500 pounds of Dry Chemical
- One Oshkosh P-19 High Reach with:
 - 1,500 gallons of water
 - 310 gallons of aqueous fire fighting foam
 - 550 pounds of Dry Chemical
- One Oshkosh P-4 Airport Fire Truck with:
 - 1,500 gallons of water
 - 180 gallons of aqueous fire fighting foam

- One Oshkosh T-1500 Airport Fire Truck with (reserve equipment):
 - 1,585 gallons of water
 - 205 gallons of aqueous fire fighting foam
 - 700 pounds of Dry Chemical

Maintenance Facilities

The airport field maintenance facilities are located on the west apron, with direct access to all airside facilities. Security gates also permit access to the airport industrial park west of the airfield. This building has approximately 44,000 square feet which provides office space and storage of some equipment. The building immediately north has approximately 24,000 square feet and provides additional equipment storage. Three 4,000-gallon and one 6,000-gallon above-ground fuel storage tanks are also provided at this location. Two of these tanks contain diesel fuel, one contains unleaded fuel, and the final 6,000-gallon tank contains liquid runway de-icing fluid.

Fuel Storage

Each of the FBOs maintains a fuel farm, providing fuel to the airlines and general aviation aircraft. Silverhawk Jet Center has storage capabilities for 34,000 gallons of Jet A fuel, and 12,000 gallons of Avgas (100LL) fuel. These storage tanks are co-located with the Duncan Aviation fuel farm on the east side of the airport. Duncan Aviation is equipped with four 50,000-gallon tanks, with each used for the

storage of Jet A fuel, and a single 30,000-gallon storage tank for Avgas fuel. There is also a privately owned below-ground fuel storage tank with a capacity of 20,000 gallons which is used to store Jet A fuel. This tank is adjacent to the Ameritas corporate hangar.

De-icing Fluid Storage

There are five glycol (liquid de-icing fluid) storage tanks located south of the terminal ramp. All of the tanks are above-ground and have the following capacities and primary users:

- Two 6,000 gallon tanks utilized by United Express.
- One 2,000 gallon tank utilized by Northwest Airlinck.
- Two 1,000 gallon tanks (in concrete vault) for general usage.

OTHER FACILITIES

Office Building

Currently, an office building is located adjacent to the southern edge of the general aviation apron. Office space is provided for the FAA and the Nebraska Department Aeronautics (NDA) headquarters and one commercial office.

Lincoln Air Park West

Lincoln Air Park West is an industrial park encompassing more than 1,280 acres located on the west side of the

airfield. There are over 500 acres readily available and over 50 current tenants. This site was taken over by the Lincoln Airport Authority in 1966 when the Lincoln Air Force Base was closed, and is now used for airfield operations revenue support. The majority of the tenants of the air park are warehouses and light manufacturing operations. The northern portion of the air park has access to the Burlington Northern rail system in addition to the accessibility to the Lincoln Airport runway system. The Lincoln Air Park is located 2.3 miles from Interstate Highway 80, which provides access to all the major Midwestern markets.

The new Lincoln Air Park Rail Center is in the process of being constructed in the air park. This rail center could ultimately accommodate 700,000 square feet of building space able to accommodate multiple tenants and may be a hub for the distribution of warehouse merchandise, light manufacturing, and assembly for the Midwest. Rail service to the Lincoln Air Park, including the new Lincoln Air Park Rail Center, is provided by a north/south spur, owned by the Lincoln Airport Authority, which connects to the Burlington Northern Santa Fe Railroad.

Lincoln Air Park South

The airport maintains approximately 120 acres of property that is available for industrial/commercial development. This parcel is located to the

immediate south of West Adams Street and to the east of the Nebraska Air National Guard property. The area can be divided into smaller parcels of marketable size as required by a prospective lessee. The suggested land use would also include office space or warehousing facilities.

Air National Guard and Army National Guard Facilities

Lincoln Airport is utilized by the Nebraska Air National Guard's (NEANG) 155th Air Refueling Wing, as well as the Army National Guard (NEARNG). The 155th Air Refueling Wing operates nine KC-135 refueling aircraft. The NEANG has approximately 279 men and women stationed at the Lincoln Airport on the weekdays and approximately 930 on the weekends. The NEANG facilities are located to the south of the terminal area. The NEARNG currently does not have aircraft stationed at Lincoln Airport, and its facilities are located south of the NEANG facilities.

UTILITIES

The availability and capacity of the utilities serving the airport are factors in determining the development potential of the airport property, as well as the land immediately adjacent to the facility. Of primary concern in the inventory investigation is the availability of water, gas, sewer, and power sources. **Exhibit 1G** presents the existing primary utility lines.

Electric Power

Electricity is provided to the airport by The Lincoln Electric System (LES), an independently governed, municipally owned corporation. Power is supplied by power lines from the east for the general aviation area and the east electric vault. The terminal building area is supplied by power lines from the southwest through the National Guard area. The maintenance building and the west electric vault is supplied by power lines from the west.

The east electric vault provides airfield lighting for five taxiway circuits, Runway 17-35, Runway 14-32, PAPIs and VASIs. The west electric vault provides airfield lighting for 10 taxiway circuits and Runway 18-36. Emergency generators are available at the electrical vaults, the maintenance building, and the terminal building.

Natural Gas

Aquila is the supplier of natural gas to Lincoln Airport. A four-inch main enters the airport from the southeast of the general aviation area. This main serves the general aviation area and the airport terminal. A ten-inch main enters the airport from the east and north of the general aviation area. This main runs along North Park Road inside of the security fence to the west side and serves the Air Park West area. The guard unit has a separate gas line entering their property at the southwest corner.

Water

The City of Lincoln Water Department provides Lincoln Airport with water service. A 16-inch main enters the airport in the southeast corner. The terminal building area and National Guard Base are served by a 12-inch main which parallels West Adams Street and is ultimately connected to the 16-inch main. A 16-inch main, which is northeast of the airport, connects to the existing system on the west side of the airport to provide a looped distribution system to the airport.

The water system includes the 3.0 million gallon Arnold Heights above-ground storage reservoir, which is located west of the airport on West Superior Street.

Sanitary Sewer







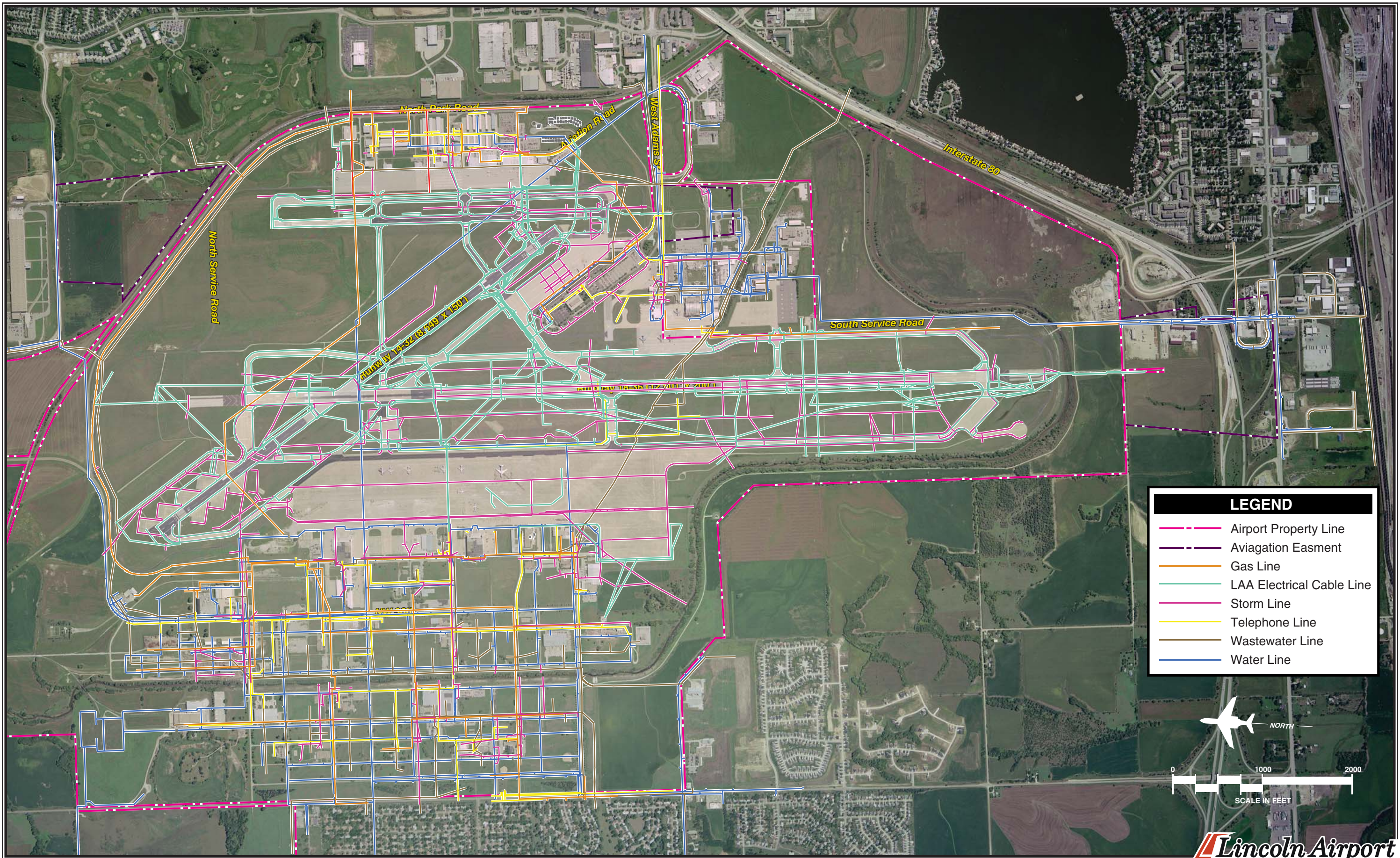

Sanitary sewer service is provided to the Lincoln Airport by the City of Lincoln Waste Water Department via the Oak Creek Trunk Sewer and the Theresa Street Sewage Treatment Plant. The terminal building area is served by a 12-inch sanitary sewer line and the general aviation area is served by an eight-inch sanitary sewer line which eventually connects to the Oak Creek Trunk Sewer.

Drainage System

Lincoln Airport is served by an extensive storm drainage system including



LEGEND

-  Airport Property Line
-  Avigation Easement
-  Gas Line
-  LAA Electrical Cable Line
-  Storm Line
-  Telephone Line
-  Wastewater Line
-  Water Line

 NORTH

0 1000 2000

SCALE IN FEET

storm sewer pipes, inlets, and open ditches. This includes the entire airport operations area and the Lincoln Air Park area.

Oak Creek, which drains approximately 160 square miles to the north and west of the airport, flows from north to south along the west side of the airport, bends around the south end of Runway 36, and flows on to the east. Virtually all of the drainage from the airport eventually discharges to Oak Creek.

Most of the storm water runoff from the air operations area is collected by three major drainage systems. The first system drains the west apron. It consists of a storm sewer which runs along the west side of the west apron and discharges into Oak Creek. The second system drains the area between the west apron, Runway 18-36, and the southern portion of Taxiway D. This second system also discharges into Oak Creek.

The third system drains the east portion of the airfield including the terminal apron, general aviation apron, and a portion of the Highlands area to the northeast of the airport. This system drains off of the airport into an open ditch on the Nebraska Air National Guard Base.

GENERAL ACCESS TO LINCOLN AIRPORT – SURROUNDING ROADS

Lincoln Airport is located immediately west and north of Interstate 80, and is accessible via the West Adam's Street

exit. The airport is bordered on the north by North Park Road, on the east by North Park Road, on the south by Interstate Highway 80 and West Vine Street, and to the west by Northwest 38th Street.

Interstate 80 serves the Lincoln metropolitan area, providing access to Omaha to the east and Denver and Cheyenne to the west. U.S. Highway 77 runs through Lincoln in a north/south direction, originating in South Sioux City to the north on the South Dakota/Iowa border, to Beatrice near the Kansas border in the south. U.S. Highway 34, U.S. Highway 6, Nebraska State Highway 2, and Nebraska State Highway 79 also serve the Lincoln area.

COMPETITIVE MODES

Alternative methods of transportation in the Lincoln area include: private automobiles, busing, truck freight, and the railroads. Public bus transportation does not provide services to the airport, but taxi services are available at all times. Several large truck lines operate out of Lincoln, providing Lincoln area businesses with freight services accessing the entire country. Amtrak provides passenger rail service, while cargo rail service is provided by Burlington Northern/Santa Fe and Union Pacific.

SOCIOECONOMIC PROFILE

During the preparation of this section, historical and forecasted socioeco-

conomic figures were obtained from the Nebraska Department of Economic Development, the Nebraska Department of Natural Resources, the Nebraska Department of Labor, the University of Nebraska Bureau of Business Research, as well as several federal agencies and private organizations. The following sections will analyze the population, employment, income, and housing of the region as it compares to state and national figures.

POPULATION

Historical population information for the City of Lincoln, Lancaster County, and the State of Nebraska is summarized in **Table 1K**. As indicated in the table, the City of Lincoln experienced steady growth through the years. The City of Lincoln and Lancaster County have both enjoyed nearly 1.5 percent annual growth since 1990. In comparison, the entire State of Nebraska has experienced an annual growth rate of 0.72 percent.

| TABLE 1K Historical Population | | | | | |
|---|-------------|-------------|-------------|-------------|---|
| | 1990 | 1995 | 2000 | 2005 | Average Annual Growth Rate 1990-2005 |
| City of Lincoln | 191,972 | 208,099 | 225,581 | 239,213 | 1.48% |
| Lancaster County | 213,416 | 231,119 | 250,291 | 264,814 | 1.45% |
| State of Nebraska | 1,578,417 | 1,644,455 | 1,713,261 | 1,758,787 | 0.72% |

Source: City of Lincoln Wastewater Facilities Plan Update 2002; 2005 population from Nebraska Department of Natural Resources - Historical Populations

EMPLOYMENT

Employment opportunities affect migration to the metropolitan area and

population growth. The City of Lincoln has consistently been below the national and state average unemployment rate, as shown in **Table 1L**.

| TABLE 1L Historical Unemployment Rates | | | | |
|---|------------------------|-------------------------|--------------------------|------------------------------|
| Year | City of Lincoln | Lancaster County | State of Nebraska | Midwest United States |
| 1996 | 2.50% | 2.40% | 2.80% | 4.50% |
| 1997 | 2.20% | 2.10% | 2.40% | 4.10% |
| 1998 | 2.20% | 2.10% | 2.50% | 3.70% |
| 1999 | 2.40% | 2.30% | 2.80% | 3.60% |
| 2000 | 2.50% | 2.40% | 2.80% | 3.60% |
| 2001 | 2.80% | 2.70% | 3.10% | 4.50% |
| 2002 | 3.40% | 3.20% | 3.70% | 5.50% |
| 2003 | 3.80% | 3.70% | 4.00% | 5.90% |
| 2004 | 3.60% | 3.50% | 3.90% | 5.70% |
| 2005 | 3.60% | 3.50% | 3.80% | 5.40% |

Source: U.S. Department of Labor, Bureau of Labor Statistics, 2006

Table 1M summarizes total employment by sector for the Lincoln Metropolitan Area from 2001 to July 2006. As shown in the table, the Lincoln Metropolitan Area recorded growth in total employment each year over this five year time period. Total employment grew by 11,643, a 7.3 percent increase. The sectors that experienced the greatest average annual growth rate were the financial activities sec-

tor at 5.5 percent, the services sector at 3.6 percent, and transport & public utilities and natural resources & construction each at 2.6 percent. Sectors experiencing negative growth rates include the information sector at -4.0 percent a year, manufacturing at -3.3 percent, wholesale trade at -2.2 percent and government at -0.5 percent over the same five-year time period.

| Sector | 2001 | 2002 | 2003 | 2004 | 2005 | 2006* | Average Annual Growth/Reduction Rate |
|---------------------------------|----------------|----------------|----------------|----------------|----------------|----------------|---|
| Natural Resource & Construction | 7,969 | 8,106 | 8,602 | 8,852 | 8,372 | 9,074 | 2.6% |
| Manufacturing | 17,518 | 16,580 | 16,371 | 15,664 | 15,199 | 14,814 | -3.3% |
| Transport & Public Utilities | 6,720 | 6,448 | 6,943 | 7,028 | 7,483 | 7,637 | 2.6% |
| Wholesale Trade | 4,648 | 4,553 | 4,621 | 4,194 | 4,085 | 4,152 | -2.2% |
| Retail Trade | 16,418 | 16,368 | 17,390 | 17,390 | 17,533 | 16,916 | 0.6% |
| Information | 3,580 | 3,363 | 3,559 | 3,172 | 3,023 | 2,924 | -4.0% |
| Financial Activities | 10,301 | 10,785 | 11,378 | 11,787 | 12,594 | 13,433 | 5.5% |
| Services | 56,561 | 57,323 | 61,250 | 62,803 | 64,327 | 67,375 | 3.6% |
| Government | 35,738 | 35,975 | 36,627 | 36,543 | 36,770 | 34,771 | -0.5% |
| Total Employment | 159,453 | 159,501 | 166,741 | 167,433 | 169,386 | 171,096 | 1.4% |

Source: Nebraska Department of Labor, 2006
* Through July, 2006

INCOME

Table 1N compares the per capita income (PCPI) for Lancaster County, the State of Nebraska, and the United States between 1990 and 2005. As illustrated in the table, Lancaster County PCPI has grown at a greater

pace than both the state of Nebraska and the U.S. By 2005, the Lancaster County PCPI had nearly caught up with that of the U.S. Thus, overall income for Lancaster County has been increasing and has increased at a greater rate than both the State of Nebraska and the U.S.

| | 1990 | 1995 | 2000 | 2005 | Average Annual Growth Rate 1990-2005 |
|-------------------|-------------|-------------|-------------|-------------|---|
| Lancaster County | \$21,053 | \$23,065 | \$27,344 | \$28,369 | 2.01% |
| State of Nebraska | \$20,899 | \$22,197 | \$25,842 | \$27,229 | 1.78% |
| United States | \$22,634 | \$23,573 | \$27,919 | \$28,562 | 1.56% |

Source: Woods & Poole Economics, CEDDS, 2006

ENVIRONMENTAL INVENTORY

Available information about the existing environmental conditions at Lincoln Airport has been derived from internet resources, agency maps, and existing literature. The intent of this task is to inventory potential environmental sensitivities that might affect future improvements at the airport. **Exhibit B1** in **Appendix B** depicts many of the environmental resources located within the airport environs. These resources are discussed further within the following sections.

Fish, Wildlife, and Plants

The Fish and Wildlife Service (FWS) and the National Marine Fisheries Service (NMFS) are charged with overseeing the requirements contained within Section 7 of the *Endangered Species Act*. This Act was put into place to protect animal or plant species whose populations are threatened by human activities. Along with the

FAA, the FWS and the NFMS review projects to determine if a significant impact to these protected species will result with implementation of a proposed project. Significant impacts occur when the proposed action could jeopardize the continued existence of a protected species, or would result in the destruction or adverse modification of federally designated critical habitat in the area.

In a similar manner, states are allowed to prepare statewide wildlife conservation plans through authorizations contained within the *Sikes Act*. Airport improvement projects should be checked for consistency with the State or DOD Wildlife Conservation Plans where such plans exist.

Table 1P depicts federally and state-listed threatened and endangered species in Lancaster County. Records indicate that the Salt Creek Tiger Beetle is known to occur within and adjacent to the saline wetlands located in the areas between Oak Creek and Interstate 80.

| TABLE 1P Threatened, Endangered, or Candidate Species | | |
|--|---------------------------------------|---------------|
| Common Name | Scientific Name | Status |
| Bald eagle | <i>Haliaeetus leucocephalus</i> | T |
| Salt Creek Tiger Beetle | <i>Cicindela nevadica lincolniana</i> | C |
| Western Prairie Fringed Orchid | <i>Platanthera praeclara</i> | T |
| <i>Source: U.S. Fish and Wildlife Service, Lancaster County Species List</i> | | |

Floodplains

Floodplains are defined in *Executive Order 11988, Floodplain Management*, as “the lowland and relatively flat areas adjoining inland and coastal wa-

ters...including at a minimum, that area subject to a one percent or greater chance of flooding in any given year” (i.e., that area would be inundated by a 100-year flood). Federal agencies, including the FAA, are di-

rected to “reduce the risk of loss, to minimize the impact of floods on human safety, health, and welfare, and to restore and preserve the natural and beneficial values served by floodplains.” To the south, the 100-year floodplain encroaches onto airport property based on a 2007 Letter of map Revision submitted to FEMA. To the west, the improvements to the levee system through the industrial park have contained the 100-year floodplain within the Oak Creek channel, which is reflected in a 2004 Letter of Map Revision to FEMA.

Wetlands and Waters of the U.S.

The U.S. Army Corps of Engineers regulates the discharge of dredged and/or fill material into waters of the United States, including adjacent wetlands, under Section 404 of the *Clean Water Act*. Wetlands are defined in *Executive Order 11990, Protection of Wetlands*, as “those areas that are inundated by surface or groundwater with a frequency sufficient to support and under normal circumstances does or would support a prevalence of vegetation or aquatic life that requires saturated or seasonably saturated soil conditions for growth and reproduction.” Categories of wetlands include swamps, marshes, bogs, sloughs, pot-holes, wet meadows, river overflows, mud flats, natural ponds, estuarine areas, tidal overflows, and shallow lakes and ponds with emergent vegetation. Wetlands exhibit three characteristics: hydrology, hydrophytes (plants able to tolerate various degrees of flooding or frequent saturation), and poorly drained soils.

According to the U.S. Fish and Wildlife Service’s wetland mapper, a number of wetland areas are present within the airport environs (refer to **Exhibit B1**). The largest of these areas is the saline wetland which is located west of the Runway 35 end and south of Oak Creek. Additional wetland areas are found scattered through the airpark as well as areas north of North Park Road.

Historical, Architectural, and Cultural Resources

Determination of a project’s impact to historic and cultural resources is made in compliance with the *National Historic Preservation Act (NHPA) of 1966*, as amended for federal undertakings. Two state acts also require consideration of cultural resources. The NHPA requires that an initial review be made of an undertaking’s *Area of Potential Effect (APE)* to determine if any properties in or eligible for inclusion in the National Register of Historic Places are present in the area.

One known historic site is the Lincoln Army Air Field Regimental Chapel, which is located west of the airport along NW 48th Street. This historic site is not on airport property.

Department of Transportation Act: Section 4(f)

Section 4(f) properties includes publicly-owned land from a public park, recreation area, or wildlife and waterfowl refuge of national, state, or local significance; or any land from a his-

toric site of national, state, or local significance. There are no section 4(f) resources located on airport property. Parks and recreational areas located in the vicinity of the airport include the Highlands Golf Course, Bowling Lake Park, and Olympic Heights Park.

Farmlands

The *Farmland Protection Policy Act (FPPA)* authorizes the Department of Agriculture to develop criteria for identifying the effects of federal programs on the conversion of farmland to nonagricultural uses. Farmland protected by the FPPA is classified as either unique farmland, prime farmland (which is not already committed to urban development or water storage), or farmland which is of state or local importance (as determined by the appropriate government agency and the Secretary of Agriculture).

Much of the undeveloped property surrounding the airport is considered prime farmland by the United States Department of Agriculture Natural Resource Conservation Service (formally the Soil Conservation Service).

DOCUMENT SOURCES

A variety of sources were used during the inventory process. The following listing reflects a partial compilation of these sources. In addition, considerable information was provided directly to the consultant by Lincoln Airport.

AirNAV Airport information, website:
www.airnav.com

Airport/Facility Directory North Central U.S. Edition; September 28, 2006

FAA Terminal Area Forecast

Lincoln Airport Authority

Nebraska Department of Aviation

Nebraska Department of Labor

Nebraska Department of Natural Resources

Omaha Sectional Chart, US Department of Commerce, National Oceanic and Atmospheric Administration; May 11, 2006

Regional Economic Information System, Bureau of Economic Analysis

U.S. Department of Commerce, April 2005

U.S. Department of Labor, Bureau of Labor Statistics, 2006

U.S. Terminal Procedures North Central Edition; September 28, 2006

University of Nebraska Bureau of Business Research

Woods & Poole Economics, CEDDS, 2006

The Weather Channel, website:
www.weather.com; NOAA

Lincoln Airport

FORECASTS

An important factor in facility planning involves a definition of demand that may reasonably be expected to occur during the useful life of the facility's key components. In airport master planning, this involves projecting potential aviation activity for a twenty-year timeframe. Forecasting for non-hub primary commercial service airports, such as Lincoln Airport (LNK), should consider passengers, cargo, based aircraft, and operations (takeoffs and landings) which will serve as the basis for facility planning.

The Federal Aviation Administration (FAA) has oversight responsibility to review and approve aviation forecasts developed in conjunction with airport planning studies. The FAA reviews such forecasts with the objective of comparing them to its

Terminal Area Forecasts (TAF) and the National Plan of Integrated Airport Systems (NPIAS). In addition, aviation activity forecasts are an important input to the benefit-cost analyses associated with airport development, and FAA reviews these analyses when federal funding requests are submitted.

As stated in FAA Order 5090.3C, Field Formulation of the National Plan of Integrated Airport Systems (NPIAS), dated December 4, 2004, forecasts should be:

- Realistic
- Based on the latest available data
- Reflect current conditions at the airport
- Supported by information in the study
- Provide adequate justification for airport planning and development



The forecast process for an airport master plan consists of a series of basic steps that can vary depending upon the issues to be addressed and the level of effort required to develop the forecast. The steps include a review of previous forecasts, determination of data needs, identification of data sources, collection of data, selection of forecast methods, preparation of the forecasts, and evaluation and documentation of the results.

The following forecast analysis for Lincoln Airport was produced following these basic guidelines. Previous forecasts dating back to the previous master plan are examined and compared against current and historic activity. The historical aviation activity is then examined along with other factors and trends that can affect demand. The intent is to provide an updated set of aviation-demand projections for LNK that will permit the Airport Authority to make planning adjustments as necessary to maintain a viable, efficient, and cost-effective facility.

NATIONAL AVIATION TRENDS

Each year, the FAA updates and publishes a national aviation forecast. Included in this publication are forecasts for the large air carriers, regional/commuter air carriers, general aviation, and FAA workload measures. The forecasts are prepared to meet budget and planning needs of the constituent units of the FAA and to provide information that can be used by state and local authorities, the avia-

tion industry, and the general public. The current edition when this chapter was prepared was FAA *Aerospace Forecasts-Fiscal Years 2006-2017*, published in March 2006. The forecasts use the economic performance of the United States as an indicator of future aviation industry growth. Similar economic analyses are applied to the outlook for aviation growth in international markets.

In the seven years prior to the events of September 11, 2001, the U.S. civil aviation industry experienced unprecedented growth in demand and profits. The impacts to the economy and aviation industry from the events of 9/11 were immediate and significant. The economic climate and aviation industry, however, has been on the recovery.

The Office of Management and Budget (OMB) expects the U.S. economy to continue to grow in terms of Gross Domestic Product (GDP) at an average annual rate of 3.1 percent over the next 12 years. This will positively influence the aviation industry, leading to passenger, air cargo, and general aviation growth throughout the forecast period (assuming there will be no new successful terrorists incidents against either U.S. or world aviation).

U.S. airline passengers (combined domestic and international) have now exceeded pre-9/11 levels, and are projected to grow at an average of 3.1 percent annually through 2017. Mainline air carriers will grow at 2.8 percent annually, while the regional/commuter airlines are expected to maintain a stronger pace of 4.3 percent annually.

U.S. airline air cargo revenue-ton-miles (RTMs) are projected to grow at 5.5 percent annually. The number of active general aviation aircraft is expected to grow at 1.4 percent annually.

COMMERCIAL PASSENGER AIRLINES

The passenger airlines in the United States are comprised of 34 mainline carriers and 79 regional carriers. The mainline carriers are airlines that primarily use passenger jets with over 90 seats, while the regional carriers are airlines that primarily use smaller propeller and jet aircraft with up to 90 seats. The mainline carriers have also emerged into two other groupings: legacy network carriers and low-cost carriers.

Legacy Network Carriers - This group includes the airlines established prior to deregulation in 1978 (e.g., Alaska Airlines, American Airlines, Continental Airlines, Delta Airlines, Northwest Airlines, United Airlines, US Airways). The legacy airlines were the most impacted by 9/11, and now are undergoing restructuring efforts to redefine themselves in the new operating environment of the industry. These airlines operate primarily in hub-and-spoke networks and generally have higher operating costs. The legacy airlines have been downsizing and cost-cutting to become competitive with the low-cost carriers. The string of negative external events, out of the control of the airlines, has made it difficult for most legacy carriers to achieve profitability.

Low-Cost Carriers - This group is comprised of established low-cost carriers, new entrants, and a few restructured legacy carriers (American Trans Air, AirTran, Frontier Airlines, Jet-Blue Airways, Southwest Airlines, and Spirit Air Lines). These carriers typically operate point-to-point and have lower operating costs than their legacy counterparts. Their post-9/11 strategy has been growth in airports and city-pairs served, aircraft fleet, and longer-haul flights. The recent sharp increases in oil prices have impacted the profits of the low-cost airlines.

Regionals/Commuters - This group's operating strategy focuses around providing feeder traffic through a code-sharing arrangement with a legacy airline. Some, like the now-defunct Independence Air, have attempted point-to-point service in competition with the larger carriers. Since 9/11, the regional commuters have benefited from the route restructuring and cost-cutting of the legacy network, taking over service to thinner medium-haul and long-haul markets.

While continuing to recover from 9/11, new challenges and uncertainties unfolded. A slowed economy, the Severe Acute Respiratory Syndrome (SARS) epidemic, and the war in Iraq all added to the difficulties already facing the industry. Since 2000, legacy air carrier enplanements are down over 18 percent. Their market share has declined from 70 percent in 2000 to 55 percent in 2005. Despite the continued declines in the legacy air carrier enplanements, system-wide domestic enplanements were up 6.6 percent in 2005.

System capacity is measured in available seat-miles (ASM), and it declined 20 percent immediately following 9/11. While recovery took some time, system capacity finally exceeded the pre-9/11 levels in 2004. Domestic ASMs grew 3.5 percent in 2005, due to large gains by the low-cost and regional carriers.

In 2006, however, the capacity cuts by the legacy carriers, due to continued fleet reductions and shifting to more international markets, is forecast to result in a 0.7 percent decline in domestic ASMs. Scheduled cuts by legacy carriers in Chapter 11 are expected to more than offset the continued strong growth in capacity expected from the regional carriers. In 2007, domestic capacity is expected to grow by 5.2 percent, then average 3.8 percent annual growth through 2017.

After two years of rapid growth in the recovery from 9/11, domestic revenue passenger miles (RPMs) are forecast to increase by just 0.2 percent in 2006. This reflects the effect of the anticipated domestic capacity cuts. As the capacity begins to grow again in 2007, RPMs are also forecast to increase by 4.3 percent. Projected economic growth and declining real yields result in a forecast of 3.9 percent average annual growth through 2017.

In line with the pattern expected for RPMs, the FAA has projected domestic enplanements to decline by 0.2 percent in 2006, but rebound with 3.7 percent growth in 2007. Domestic enplanements over the rest of the forecast period are projected to grow at an annual average rate of 3.2 percent. Mainline enplanement growth of 2.5 percent annually is expected to be con-

centrated in the low-cost carriers, while the regional carriers are projected to grow at 4.2 percent per year. The national enplanement history and projections are depicted on **Exhibit 2A**.

The real yield of domestic mainline traffic is expected to decline at an annual average rate of 0.8 percent through 2017. This forecast is based upon an assumption that increased competition from the low-cost carriers will continue to exert pressure on the legacy carriers to match fares on competitive routes. This competition is expected to continue to be applied not only by Southwest Airlines, but also smaller carriers such as AirTran, Frontier, and JetBlue. The newly merged US Airways may also have an impact in a broader application of simpler domestic fare structures.

Domestic aircraft size has been on the decline in recent years, primarily with the advent of the regional jet and the subsequent growth of the regional airlines. Domestic aircraft size has declined by 1.3 seats in 2005, to 120.4. The FAA projects aircraft size to continue to decline to an average of 117.7 seats by 2011. This is expected as the legacy carriers continue to downsize on domestic routes through both their partnerships with the regional carriers and by replacing wide-body and larger narrow-body aircraft with smaller narrow-body aircraft. Low-cost carriers such as JetBlue are also acquiring smaller aircraft in the 100-seat range. At the same time, the regional carriers have slowed their orders of the 50-seat regional jets and are now acquiring more in the 70 to

U.S. MAINLINE AIR CARRIERS SCHEDULED PASSENGER TRAFFIC

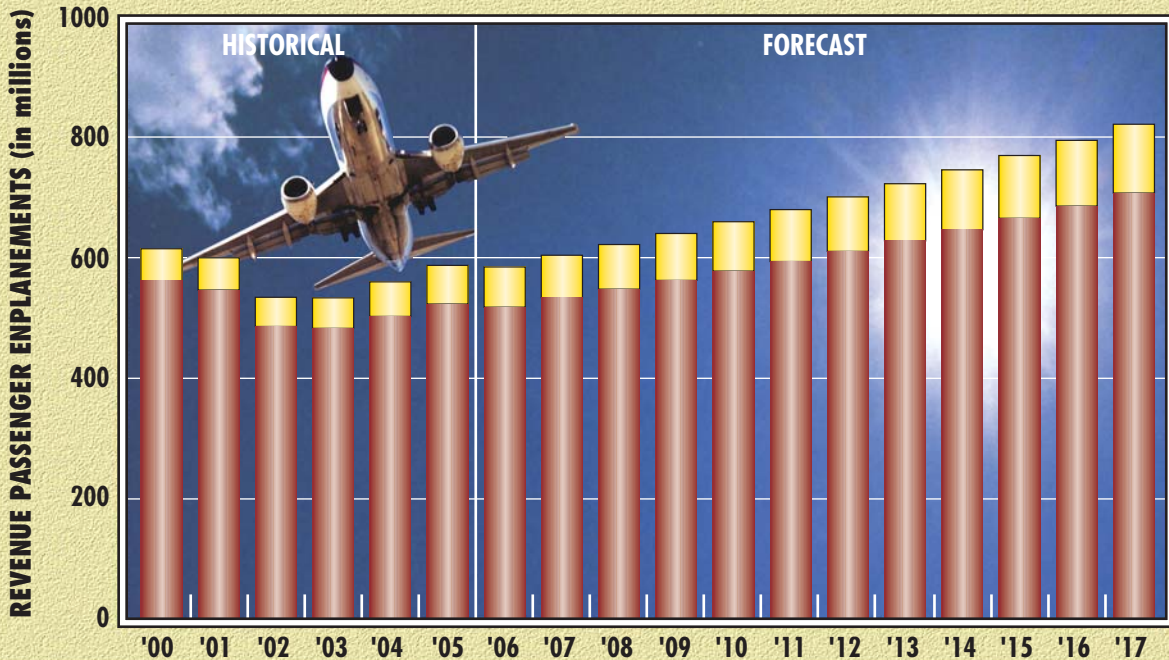

Source: Form 41, U.S. Department of Transportation

Domestic International

U.S. REGIONAL CARRIERS SCHEDULED PASSENGER TRAFFIC

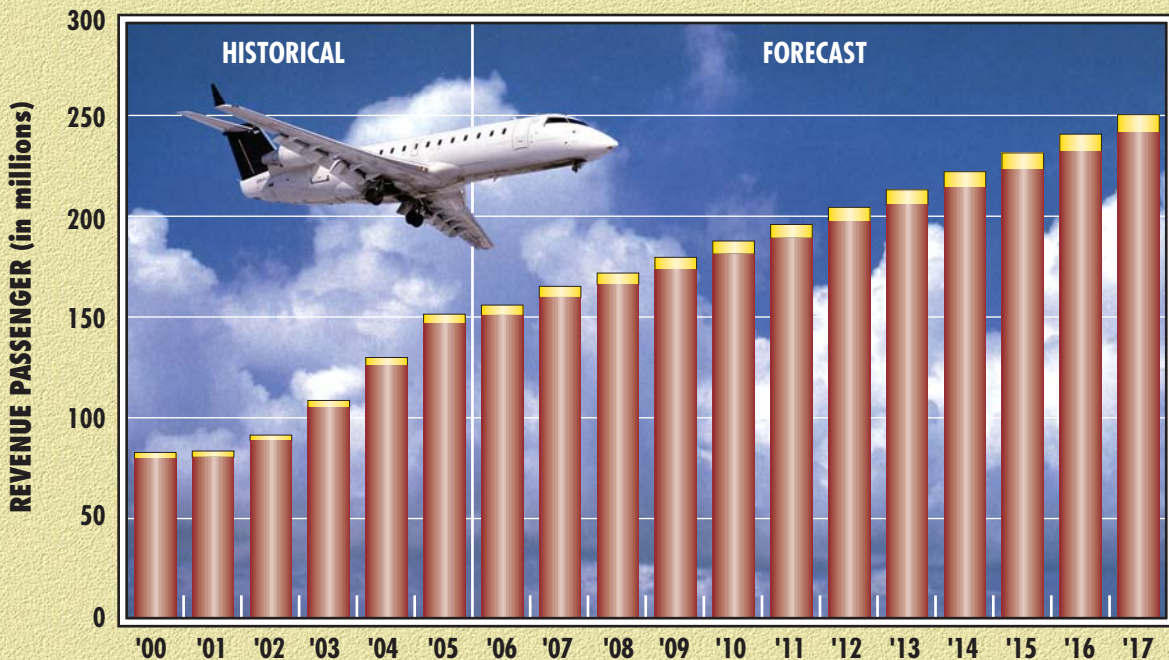

Source: Form 41 and 298C, U.S. Department of Transportation

90-seat range. This changing aircraft fleet is narrowing the gap between the size of aircraft operated by the mainline and regional carriers.

Finally, the domestic load factor has been on the rise since 2002, reaching an all-time high of 76.4 percent in 2005. This has been heavily influenced by the legacy carriers whose load factor is even higher at 78.4 percent. The average load factor is expected to increase by 0.7 percent in 2006, then grow more slowly (0.1 percent annually) through 2017.

AIR CARGO

Air cargo traffic is comprised of freight/express and mail. Air cargo is moved either in the bellies of passenger aircraft or in dedicated all-cargo aircraft. FAA data and forecasts are presented in revenue-ton-miles (RTMs).

Air cargo activity has historically had a high correlation to Gross Domestic Product (GDP). Other factors that affect air cargo growth are real yields, improved productivity, and globalization. Ongoing trends that are and will continue to improve the air cargo market include the opportunities from open-skies agreements, decreasing costs from global airline alliances, and increasing business volumes from e-commerce. At the same time, trends that could limit air cargo growth include increased use of e-mail, decreased costs of sending documents by facsimile, and increased airline costs due to environmental and security restrictions.

Before 2001, air cargo was the fastest growing sector of the aviation industry. From 1994 through 2000, total tons and RTMs grew at annual average rates of 8.0 and 8.6 percent. An economic slowdown in the U.S., combined with the collapse of the high-tech industry and a slowing of imports, resulted in declines of 5.0 percent in tons and 3.9 percent in RTMs. Traffic began to recover in 2002 and is setting new record RTMs, especially in the international market.

The FAA notes there are several structural changes occurring within the air cargo industry. Among them are the following:

- **Security regulations** – Security regulations put in place shortly after 9/11 shifted cargo from the passenger airlines to the all-cargo airlines. Additional regulations have been put in place since. These include requiring the carriers to conduct random inspections, codifying and strengthening the “known shipper” program, and establishing a security program specifically for all-cargo operations by aircraft over 20,000 pounds.
- **Market maturation** – The express market in the United States has matured after dramatic growth over the last two decades. This is the majority of domestic air cargo activity.
- **Modal shift** – Improved service and economics from the use of alternative modes of cargo transported by the integrated cargo car-

riers (e.g., FedEx, UPS, and DHL) has matured.

- **Increased USPS use of all-cargo carriers** – This initially resulted from the U.S. Postal Service’s (USPS) need to improve control over delivery. The trend has continued due to security regulations.
- **Increased use of mail substitutes** – Substitutes such as e-mail affect mail volume. The residual fear of mail because of terrorism has also been a factor.

FAA’s forecasts of air cargo RTMs are predicated on several assumptions:

- 1) security restrictions concerning air cargo transportation will stay in place;
- 2) there will be no additional terrorist attacks in the U.S.;
- 3) there will be continued domestic and international economic growth;
- 4) most of the modal shift from air to ground has occurred; and
- 5) in the long term, cargo activity will be tied to economic growth.

The number of RTMs flown by U.S. carriers grew by 7.5 percent in 2005 to 39.2 billion. Total RTMs flown are forecast to increase 5.4 percent in 2006 and 5.3 percent in 2007. Over the following ten years, total RTMs are projected to increase at an annual average rate of 5.1 percent.

Domestic cargo RTMs decreased 1.6 percent in 2005, to 16.1 billion, primarily due to the modal shift from air to ground and the impact of jet fuel

surcharges. Domestic RTMs are projected to increase 3.5 percent in 2006 and 3.4 percent in 2007. From 2008 through 2017, growth is expected to average 3.1 percent annually, based upon projected U.S. economic growth.

Between 1996 and 2005, the all-cargo carrier percentage of U.S. domestic RTMs grew from 64.6 percent to 80.8 percent. By 2017, this share is projected to increase to 84 percent based upon increases in wide-body capacity for all-cargo carriers and security considerations.

International RTMs flown by U.S. carriers grew to 23.1 billion in 2005, a 7.5 percent increase over the previous year. The FAA forecasts a 6.7 percent increase in 2006, and a 6.6 percent increase in 2007, followed by an average annual increase of 6.3 percent through 2016. The all-cargo carriers’ percentage of the international market is projected to increase from 63.8 percent in 2005, to 68.0 percent by 2017, due to increased capacity.

The all-cargo large jet aircraft fleet is expected to grow from 947 in 2004, to 1,312 by 2017. Narrow-body aircraft in the fleet are projected to decline from 54.2 percent of the fleet in 2005, to 38.6 percent by 2017. Wide-body aircraft will increase proportionally.

GENERAL AVIATION

In the 11 years since the passage of the *General Aviation Revitalization Act of 1994* (federal legislation which limits the liability on general aviation aircraft to 18 years from the date of

manufacture), it is clear that the Act has successfully infused new life into the general aviation industry. This legislation sparked an interest to renew the manufacturing of general aviation aircraft due to the reduction in product liability, as well as renewed optimism for the industry.

After the passage of this legislation, annual shipments of new aircraft rose every year between 1994 and 2000. According to the General Aviation Manufacturers Association (GAMA),

between 1994 and 2000, general aviation aircraft shipments increased at an average annual rate of more than 20 percent, increasing from 928 shipments in 1994, to 3,140 shipments in 2000. As shown in **Table 2A**, the growth in the general aviation industry slowed considerably after 2000, negatively impacted by the national economic recession and the events surrounding 9/11. In 2003, there were over 450 fewer aircraft shipments than in 2000, a decline of 14 percent.

| Year | Total | SEP | MEP | TP | J | Net Billings (\$ millions) |
|-------------|--------------|------------|------------|-----------|----------|---------------------------------------|
| 2000 | 3,140 | 1,862 | 103 | 415 | 760 | 13,497.0 |
| 2001 | 2,994 | 1,644 | 147 | 421 | 782 | 13,866.6 |
| 2002 | 2,687 | 1,601 | 130 | 280 | 676 | 11,823.1 |
| 2003 | 2,686 | 1,825 | 71 | 272 | 518 | 9,994.8 |
| 2004 | 2,963 | 1,999 | 52 | 321 | 591 | 11,903.8 |
| 2005 | 3,580 | 2,326 | 139 | 365 | 750 | 15,140.0 |

SEP - Single Engine Piston; MEP - Multi-Engine Piston; TP - Turboprop; J - Turbofan/Turbojet

Source: GAMA

In 2004, the general aviation production showed a significant increase, returning near pre-9/11 levels for most indicators. With the exception of multi-engine piston aircraft deliveries, deliveries of new aircraft in all categories increased. In 2005, total aircraft deliveries increased 17 percent. The largest increase was in single engine piston aircraft deliveries that increased 14 percent or by over 300 aircraft. Turbojet deliveries increased 21 percent, growing by more than 159 aircraft to 750 total aircraft. As evidenced in the table, new aircraft deliveries exceed pre-9/11 levels.

On July 21, 2004, the FAA published the final rule for sport aircraft. The *Certification of Aircraft and Airmen for the Operation of Light-Sport Aircraft* rules, which went into effect on September 1, 2004. This Final rule establishes new light-sport aircraft categories and allows aircraft manufacturers to build and sell completed aircraft without obtaining type and production certificates. Instead, aircraft manufacturers will build to industry consensus standards. This reduces development costs and subsequent aircraft acquisition costs. This new category places specific conditions on the design

of the aircraft, to limit them to “slow (less than 120 knots maximum) and simple” performance aircraft. New pilot training times are reduced and offer more flexibility in the type of aircraft which the pilot would be allowed to operate.

Viewed by many within the general aviation industry as a revolutionary change in the regulation of recreational aircraft, this new rule is anticipated to significantly increase access to general aviation by reducing the time required to earn a pilot’s license and the cost of owning and operating an aircraft. Since 2004, there have been over 30 new product offerings in the airplane category alone. These regulations are aimed primarily at the recreational aircraft owner/operator. By 2017, there is expected to be 14,000 of these aircraft in the national fleet.

While impacting aircraft production and delivery, the events of 9/11 and economic downturn have not had the same negative impact on the business/corporate side of general aviation. The increased security measures placed on commercial flights have increased interest in fractional and corporate aircraft ownership, as well as on-demand charter flights. According to GAMA, the total number of corporate operators has increased every year since 1992. Corporate operators are defined as those companies that have their own flight departments and utilize general aviation airplanes to enhance productivity. **Table 2B** summarizes the number of U.S. companies operating fixed-wing turbine aircraft since 1991.

| Year | Number of Operators | Number of Aircraft |
|-------------|----------------------------|---------------------------|
| 1991 | 6,584 | 9,504 |
| 1992 | 6,492 | 9,504 |
| 1993 | 6,747 | 9,594 |
| 1994 | 6,869 | 10,044 |
| 1995 | 7,126 | 10,321 |
| 1996 | 7,406 | 11,285 |
| 1997 | 7,805 | 11,774 |
| 1998 | 8,236 | 12,425 |
| 1999 | 8,778 | 13,148 |
| 2000 | 9,317 | 14,079 |
| 2001 | 9,709 | 14,837 |
| 2002 | 10,191 | 15,569 |
| 2003 | 10,661 | 15,870 |
| 2004 | 10,735 | 16,369 |
| 2005 | 10,809 | 16,867 |

Source: GAMA/NBAA

The growth in corporate operators comes at a time when fractional aircraft programs are experiencing significant growth. Fractional ownership programs sell a share in an aircraft at a fixed cost. This cost, plus monthly maintenance fees, allows the shareholder a set number of hours of use per year and provides for the management and pilot services associated with the aircraft's operation. These programs guarantee the aircraft is available at any time, with short notice. Fractional ownership programs offer the shareholder a more efficient use of time (when compared with commercial air service) by providing faster point-to-point travel times and

the ability to conduct business confidentially while flying. The lower initial startup costs (when compared with acquiring and establishing a flight department) and easier exiting options are also positive benefits.

Since beginning in 1986, fractional jet programs have flourished. **Table 2C** summarizes the growth in fractional shares since 1986. The number of aircraft in fractional jet programs has grown rapidly. In 2001, there were 696 aircraft in fractional jet programs. This grew to 776 aircraft in fractional jet programs at the end of 2002, and 826 in 2003. There were 949 aircraft at the end of 2005.

| Year | Number of Shares | Number of Aircraft |
|-------------|-------------------------|---------------------------|
| 1986 | 3 | NA |
| 1987 | 5 | NA |
| 1988 | 26 | NA |
| 1989 | 51 | NA |
| 1990 | 57 | NA |
| 1991 | 71 | NA |
| 1992 | 84 | NA |
| 1993 | 110 | NA |
| 1994 | 158 | NA |
| 1995 | 285 | NA |
| 1996 | 548 | NA |
| 1997 | 957 | NA |
| 1998 | 1,551 | NA |
| 1999 | 2,607 | NA |
| 2000 | 3,834 | NA |
| 2001 | 3,415 | 696 |
| 2002 | 4,098 | 776 |
| 2003 | 4,516 | 826 |
| 2004 | 4,765 | 865 |
| 2005 | 4,691 | 949 |

Source: GAMA

Very light jets (VLJs) are expected to enter the operational fleet in 2006. Also known as microjets, the VLJ is

defined as a jet aircraft that weighs less than 10,000 pounds. There are several new aircraft under develop-

ment, with the Eclipse 500, Cessna Mustang, and Adams 700 jets expected to enter service in 2006. These jets cost between one and two million, can take off on runways less than 3,000 feet, and cruise at 41,000 feet at speeds in excess of 300 knots. The VLJ is expected to redefine the business jet segment by expanding business jet flying and offering operational costs that can support on-demand air taxi point-to-point service. The FAA projects 100 VLJs in service in 2006. This category of aircraft is expected to expand at 400 to 500 aircraft per year, reaching nearly 5,000 aircraft by 2017.

In the seven years prior to the events of 9/11, the U.S. civil aviation industry experienced unprecedented growth in demand and profits. The impacts to the economy and aviation industry from the events of 9/11 were immediate and significant. However, the economic climate and aviation industry have been recovering in the past year. The FAA expects the U.S. economy to continue to expand through 2006 and 2007, and then continue to grow moderately (three percent annually) thereafter. This will positively influence the aviation industry, leading to passenger, air cargo, and general aviation growth throughout the forecast period (assuming there will be no new successful terrorists incidents against either U.S. or world aviation).

The FAA forecast assumes that the regulatory environment affecting general aviation will not change dramatically. The FAA recognizes that a major risk to continued economic growth is upward pressure on commodity prices, including the price of oil. However, the FAA economic mod-

els predict a 15 percent increase in oil prices in 2006, followed by a decline of 0.6 percent to 2.5 percent annually between 2007 and 2012, then rising by just over 2 percent annually for the balance of the forecast period.

The FAA projects the active general aviation aircraft fleet to increase at an average annual rate of 1.4 percent over the 12-year forecast period, increasing from 214,591 in 2005, to 252,775 in 2017. This growth is depicted on **Exhibit 2B**. FAA forecasts identify two general aviation economies that follow different market patterns. The turbojet fleet is expected to increase at an average annual rate of 4.0 percent, increasing from 16,658 in 2005, to 27,700 in 2017. Factors leading to this substantial growth include expected strong U.S. and global economic growth, the continued success of fractional-ownership programs, the introduction of the VLJ/microjet, and a continuation of the shift from commercial air travel to corporate/business air travel by business travelers and corporations. Piston-powered aircraft are projected to grow at 1.0 percent annually. Single engine piston aircraft are projected to grow at 0.3 percent annually, multi-engine piston at 1.0 percent annually, and 6.7 percent annually for piston-powered rotorcraft aircraft.

Aircraft utilization rates are projected to increase through the 12-year forecast period. The number of general aviation hours flown is projected to increase at 3.2 percent annually. Similar to active aircraft projections, there is projected disparity between piston and turbine aircraft hours flown. Hours flown in turbine aircraft

U.S. ACTIVE GENERAL AVIATION AIRCRAFT

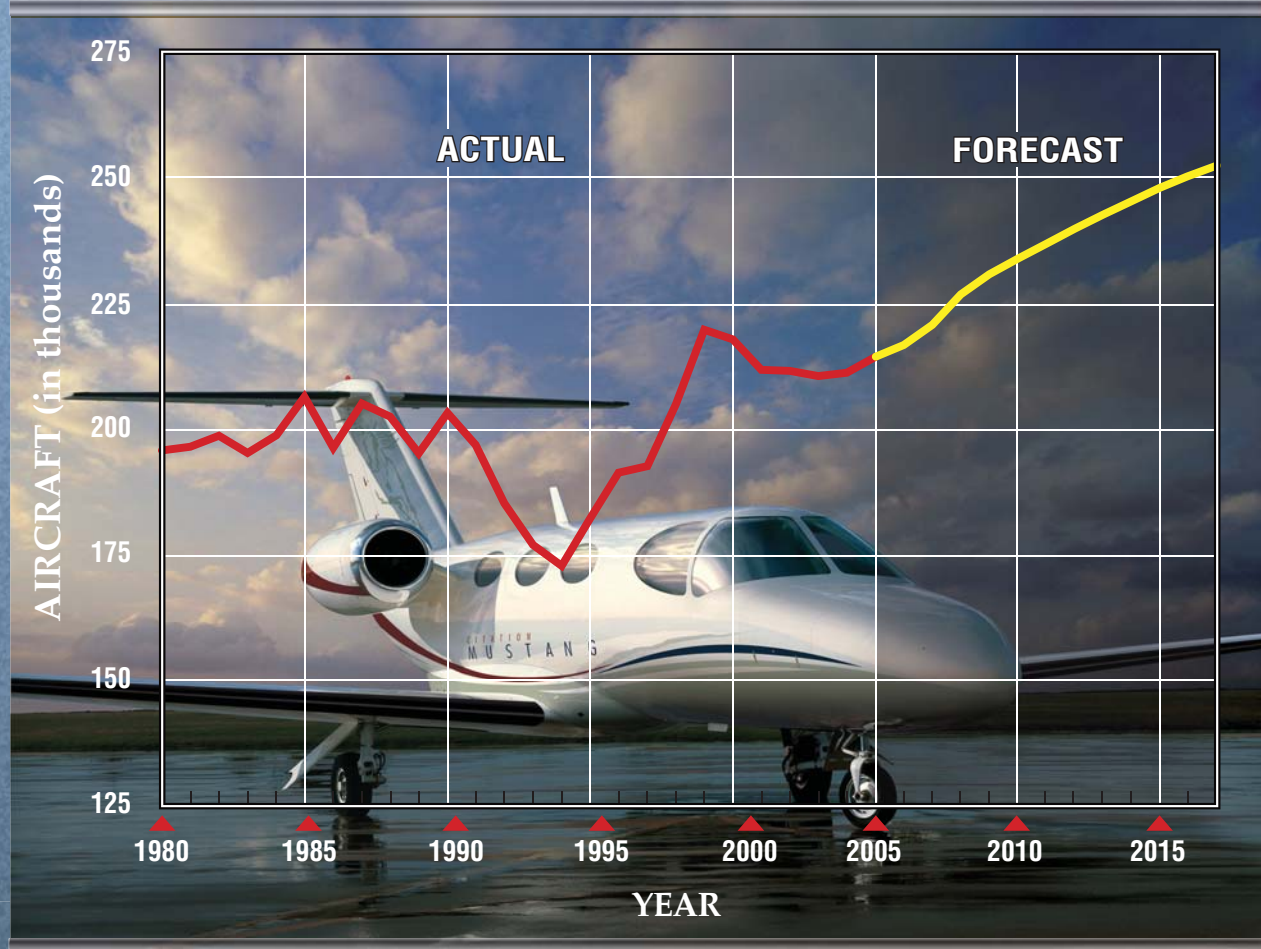

U.S. ACTIVE GENERAL AVIATION AIRCRAFT (in thousands)

| Year | FIXED WING | | | | ROTORCRAFT | | Experimental | Sport Aircraft | Other | Total |
|-------------|---------------|--------------|-----------|----------|------------|---------|--------------|----------------|-------|-------|
| | PISTON | | TURBINE | | Piston | Turbine | | | | |
| | Single Engine | Multi-Engine | Turboprop | Turbojet | | | | | | |
| 2005 (Est.) | 144.5 | 17.5 | 8.0 | 8.6 | 2.8 | 4.8 | 22.3 | N/A | 6.0 | 214.6 |
| 2009 | 146.7 | 17.6 | 8.8 | 10.8 | 4.1 | 5.4 | 23.5 | 8.2 | 5.9 | 231.0 |
| 2013 | 148.4 | 17.6 | 9.6 | 14.0 | 5.2 | 6.0 | 24.6 | 11.6 | 5.8 | 242.8 |
| 2017 | 149.7 | 17.7 | 10.4 | 17.2 | 6.0 | 6.7 | 25.7 | 13.6 | 5.7 | 252.8 |

Source: FAA Aerospace Forecasts, Fiscal Years 2006-2017.

Notes: An active aircraft is one that has a current registration and was flown at least one hour during the calendar year.

are expected to increase at 6.4 percent annually, compared with 1.8 percent for piston-powered aircraft. Jet aircraft are projected to increase at 10.2 percent annually over the next 12 years.

The total pilot population is projected to increase by 67,300 in the next 12 years from an estimated 467,611 in 2005, to 535,000 by 2017, which represents an average annual growth rate of 1.1 percent. The student pilot population is forecast to increase at an annual rate of 1.7 percent over the 12-year forecast period, reaching a total of 106,164 in 2017. Growth rates for the other pilot categories over the forecast period are as follows: airline transport pilots, up 0.1 percent; recreational pilots declining 0.6 percent annually; rotorcraft only, up 3.7 percent annually; commercial pilots up 2.1 percent annually, private pilots down 0.2 percent annually, and glider only, up 0.4 percent. The decline in recreational and private pilots is the result of the expectation that most new general aviation pilots will choose to obtain the Sport Pilot license instead.

Over the past several years, the general aviation industry has launched a series of programs and initiatives whose main goals are to promote and assure future growth within the industry. "No Plane, No Gain" is an advocacy program created in 1992 by the General Aviation Manufacturers Association (GAMA) and the National Business Aircraft Association (NBAA) to promote acceptance and increased use of general aviation as an essential, cost-effective tool for businesses. Other programs are intended to promote growth in new pilot starts and

introduce people to general aviation. "Project Pilot," sponsored by the Aircraft Owners and Pilots Association (AOPA), promotes the training of new pilots in order to increase and maintain the size of the pilot population. The "Be a Pilot" program is jointly sponsored and supported by more than 100 industry organizations. The NBAA sponsors "AvKids," a program designed to educate elementary school students about the benefits of business aviation to the community and career opportunities available to them in business aviation. Over the years, programs such as these have played an important role in the success of general aviation and will continue to be vital to its growth in the future.

There are several active local programs designed to educate the public about aviation at the Lincoln Airport. The Nebraska Military Department sponsors STARBASE for education of approximately 800 Nebraskan 5th and 6th graders. The Civil Air Patrol Lincoln Composite Squadron supports programs for 30 junior and senior members' education in aviation and participation in Civil Emergency response and support.

SERVICE AREA

The service area of an airport is typically defined by the proximity of other airports providing a similar level of service. The availability of other modes of transportation, particularly the interstate highway system, will also contribute to the defined service area. Lincoln Airport serves both scheduled commercial service as well as general aviation activity.

COMMERCIAL SERVICE

The closest commercial service airport to Lincoln Airport is Omaha Eppley Airfield, a 55-mile drive to the northeast. Interstate 80 provides a direct highway link between the two. Most major carriers including American, Continental, Delta, United, Southwest, Frontier, Northwest, US Airways, and Midwest Express provide service. Omaha Eppley Airfield recorded 1,892,000 passenger enplanements in 2004. There were 19 non-stop destinations from Omaha in 2006 including Phoenix, Las Vegas, Denver, Chicago, St. Louis, Atlanta, and New York.

Kansas City International Airport is approximately 170 miles to the southeast of Lincoln Airport. Interstate 29, located approximately 50 miles to the east of Lincoln via Nebraska Highway 2, provides a link to Kansas City. Kansas City International Airport enplaned over 5,040,000 passengers in 2004. There are 12 carriers operating from Kansas City International Airport providing non-stop service to most major metropolitan cities including destinations on both coasts.

Central Nebraska Regional Airport in Grand Island is located approximately 90 miles to the west. Interstate 80 and US Highway 34 provides direct highway access. Central Nebraska Regional Airport experienced approximately 7,000 enplanements in 2004. The airport is served by U.S. Airways Express operated by regional carrier Mesa Airlines. Daily service is provided to Omaha and Kansas City utilizing the 19-seat Beech 1900D turboprop aircraft.

The Lincoln Airport plays a key role in providing convenient air service to local users. From the Lincoln Airport, users are able to connect to large, primary commercial airports such as Chicago, Denver, Minneapolis, and Detroit in order to continue to their final destination. In addition to the convenience of the airport, competitive fares and low parking fees are attractive.

The service area for Lincoln Airport is limited to the east primarily due to the proximity of Omaha Eppley Airfield. Passenger service may extend west into rural areas in central Nebraska such as Seward and York counties, but the primary source for air passengers would likely be in Lancaster County. Lincoln Airport functions as a regional commercial service airport feeding passengers into larger hubs or to destinations for the cities it directly links.

Levels of service factors that can affect market share within a service area include frequency of service, number of airlines, type of aircraft, and non-stop destinations available. The biggest factor, however, tends to be airfares. Competition on routes and low-fare airlines are major factors that can draw vacation travelers to drive as much as three hours to a larger airport. Omaha's Eppley Airfield and Kansas City International Airport are both within a two to three-hour drive from Lincoln, and do draw some traffic from the LNK service area.

For this reason, these airports, especially Omaha, will continue to attract passengers from Lancaster County and effectively limit the service area to the east. Lincoln Airport's primary

service area for commercial services will be Lancaster County.

GENERAL AVIATION

General aviation users have a wider variety of airports from which to choose. While there are six commercial service airports in Nebraska, there are 84 other publicly-owned airports available to general aviation. Runway length is one of the first considerations for the various types of general aviation aircraft. Many small, single-engine piston, and some twin-engine aircraft can operate off runways with less than 2,500 feet of length. Cabin-class twin-engine piston aircraft and most small turboprops need 3,000 to 4,000 feet for regular operations. While some business jet aircraft can operate on less than 4,000 feet, lengths over 5,000 feet are typically necessary to be considered for regular operations by most business and corporate jet aircraft.

Lincoln Airport provides the longest general aviation runway of all the surrounding general aviation airports. As outlined in Chapter One – Inventory, Crete Municipal, Seward Municipal, and Wahoo Municipal each provide a runway length of between 4,100 feet and 4,200 feet. Wilbur Municipal Airport, to the southwest, provides a turf runway with a length of 2,345 feet.

The general aviation service area for Lincoln Airport would encompass primarily Lancaster County. It is likely that a jet aircraft owner in a neighboring county would also consider Lincoln Airport for basing, but there are very few jets registered in neighboring

counties. Thus, the service area for both commercial airlines and general aviation activity will be defined as Lancaster County.

SOCIOECONOMIC FORECASTS

The socioeconomic conditions provide an important baseline for preparing aviation demand forecasts. Local socioeconomic variables such as population, employment, and income are indicators for understanding the dynamics of the community and, in particular, the trends in aviation growth. The following is a summary of the research and projections presented in Chapter One.

POPULATION

Table 2D summarizes historical and forecast population estimates for The City of Lincoln, Lancaster County, and the State of Nebraska. The analysis of Lancaster County population indicates an average annual growth rate of 1.44 percent between 1990 and 2005. This exceeded the State growth rate of 0.72 percent over the same period. The City of Lincoln growth rate was even higher at 1.48 percent annually. Clearly, the City of Lincoln and Lancaster County represent growth centers for the entire state.

The overall population of Lancaster County is forecast to add nearly 100,000 people over the next 20 years. This represents an overall increase in population of 27 percent and an average annual growth rate of 1.59 percent. The City of Lincoln's population

is also forecast to experience significant population growth, averaging 1.58 percent annually over the next 20 years. Both of these exceed the population growth projected for the State of Nebraska as a whole, which is forecast to grow at an annual rate of 0.15 percent.

ing, and are forecast to continue to experience, are not uncommon for an area like Lancaster County. Lincoln is the State Capital and the location of the largest University in the State. Most major college towns, particularly in the Midwest, are growth centers for their state.

The trends that Lancaster County and the City of Lincoln are experienc-

| TABLE 2D | | | | | | | |
|--|-------------------|-------------|-----------------|-------------|-------------|---------------------------|---------------------|
| Socioeconomic Forecasts | | | | | | | |
| Lincoln Airport | | | | | | | |
| | HISTORICAL | | FORECAST | | | Annual Growth Rate | |
| | 1990 | 2005 | 2010 | 2015 | 2025 | 1990 to 2005 | 2005 to 2025 |
| Lancaster County | | | | | | | |
| Population | 213,641 | 264,814 | 290,473 | 312,922 | 363,159 | 1.44% | 1.59% |
| Employment | 148,000 | 196,980 | 210,970 | 225,150 | 254,140 | 1.92% | 1.28% |
| PCPI | \$21,053 | \$28,369 | \$29,573 | \$30,951 | \$34,126 | 2.01% | 0.93% |
| City of Lincoln | | | | | | | |
| Population | 191,972 | 239,213 | 261,796 | 282,029 | 327,306 | 1.48% | 1.58% |
| State of Nebraska | | | | | | | |
| Population | 1,578,417 | 1,758,787 | 1,768,997 | 1,788,508 | 1,812,787 | 0.72% | 0.15% |
| PCPI | \$20,899 | \$27,229 | \$28,797 | \$30,509 | \$34,263 | 1.78% | 1.16% |
| Employment | 994,283 | 1,217,166 | 1,298,399 | 1,379,606 | 1,541,898 | 1.36% | 1.19% |
| <i>Sources: Historical and Forecast Population – City of Lincoln Wastewater Facility Plan Update 2002 Historical and Forecast Employment & PCPI (\$1996) - Woods & Poole CEDDS, 2006</i> | | | | | | | |

EMPLOYMENT

Historical and forecast employment data for Lancaster County and the State of Nebraska are also presented in **Table 2D**. Between 1990 and 2005, Lancaster County employment grew by an average of 1.92 percent annually. This growth accounted for nearly 50,000 new jobs over the 15 year period, nearly 22 percent of the employment growth for the entire state.

Lancaster County is forecast to show continued strong employment growth

over the planning period, with an average annual growth rate of 1.28 percent between 2005 and 2025. At this rate, Lancaster County will add more than 57,000 new jobs over the next 20 years.

PER CAPITA PERSONAL INCOME (PCPI)

Table 2D also compares per capita personal income (adjusted to 1996 dollars) for the county and the state. Lancaster County's average adjusted

PCPI for 2005 is \$28,369, which is slightly more than the State of Nebraska at \$27,229. In the future, both the state and Lancaster County are forecast to grow at relatively similar rates.

FORECASTING APPROACH

The development of aviation forecasts proceeds through both analytical and judgmental processes. A series of mathematical relationships is tested to establish statistical logic and rationale for projected growth. However, the judgment of the forecast analyst, based upon professional experience, knowledge of the aviation industry, and assessment of the local situation, is important in the final determination of the preferred forecast.

The most reliable approach to estimating aviation demand is through the utilization of more than one analytical technique. Methodologies frequently considered include trend line projections, correlation/regression analysis, and market share analysis.

Trend line projections are probably the simplest and most familiar of the forecasting techniques. By fitting growth curves to historical demand data, then extending them into the future, a basic trend line projection is produced. A basic assumption of this technique is that outside factors will continue to affect aviation demand in much the same manner as in the past. As broad as this assumption may be, the trend line projection does serve as a reliable benchmark for comparing other projections.

Correlation analysis provides a measure of direct relationship between two separate sets of historic data. Should there be a reasonable correlation between the data, further evaluation using regression analysis may be employed.

Regression analysis measures the statistical relationship between dependent and independent variables yielding a "correlation coefficient." The correlation coefficient (Pearson's "r") measures association between the changes in a dependent variable and independent variable(s). If the r-squared (r^2) value (coefficient determination) is greater than 0.95, it indicates good predictive reliability. A value below 0.95 may be used with the understanding that the predictive reliability is lower.

Market share analysis involves a historical review of airport activity as a percentage, or share, of a larger regional, state, or national aviation market. A historical market share trend is determined providing an expected market share for the future. These shares are then multiplied by the forecasts of the larger geographical area to produce a market share projection. This method has the same limitations as trend line projections, but can provide a useful check on the validity of other forecasting techniques.

It is important to note that one should not assume a high level of confidence in forecasts that extend beyond five years. Facility and financial planning usually require at least a 10-year view, since it often takes more than five years to complete a major facility

development program. However, it is important to use forecasts which do not overestimate revenue-generating capabilities or understate demand for facilities needed to meet public (user) needs.

A wide range of factors is known to influence the aviation industry and can have significant impacts on the extent and nature of air service provided in both the local and national markets. Technological advances in aviation have historically altered, and will continue to change, the growth rates in aviation demand over time. The most obvious example is the impact of jet aircraft on the aviation industry, which resulted in a growth rate that far exceeded expectations. Such changes are difficult, if not impossible, to predict, and there is simply no mathematical way to estimate their impacts. Using a broad spectrum of local, regional and national socioeconomic and aviation information, and analyzing the most current aviation trends, forecasts are presented in the following sections.

The need for airport facilities at Lincoln Airport can best be determined by accounting for forecasts of future aviation demand. Therefore, the remainder of this chapter presents the forecasts for airport users and includes the following:

- **COMMERCIAL SERVICE**
 - Annual Enplaned Passengers
 - Operations and Fleet Mix
 - Peak Activity Levels
 - Annual Instrument Approaches
 - Enplaned/Deplaned Cargo

- **GENERAL AVIATION**
 - Based Aircraft
 - Based Aircraft Fleet Mix
 - Local and Itinerant Operations
 - Peak Activity Levels
 - Annual Instrument Approaches
- **AIR TAXI AND MILITARY**
 - Local and Itinerant Operations

COMMERCIAL SERVICE

To determine the types and sizes of facilities necessary to properly accommodate present and future airline activity at any airport, two basic elements must be forecast: annual enplaned passengers and annual aircraft operations. Annual enplaned passengers serve as the most basic indicator of demand for commercial service activity. From a forecast of annual enplanements, operations and other activity descriptors can be projected based upon behavioral factors characteristic of Lincoln Airport or the airline industry as a whole.

The term “enplanement” refers to a passenger boarding an airline flight. Enplaning passengers are then described in terms of either “originating,” “transfer,” or “through.” Originating passengers are those who board and depart in a commercial service aircraft from an airport. Transfer passengers are those who have departed from another location and are using the airport as an intermediate stop.

COMMERCIAL SERVICE HISTORY

In August 1997, there were two air carrier and two commuter airlines providing passenger service at Lincoln Airport. The air carrier airlines were United and TWA, while the commuter airlines were Northwest AirlinK and U.S. Airways Express (Air Midwest). United utilized a Boeing 727, 737, and 757, offering two daily departures to Chicago and two daily departures to Denver. TWA utilized a DC-9, offering four daily departures to St. Louis. Air Midwest offered four daily flights to Kansas City utilizing a Beechcraft 1900D turboprop. Northwest AirlinK offered four daily flights to Minneapolis utilizing the Dehavilland Dash 8 turboprop and the SAAB 340 turbo-prop aircraft.

Today there are two primary carriers operating at Lincoln Airport: United Express and Northwest AirlinK/Pinnacle Airlines. United Express operates Canadair Regional Jets (CRJs), with four daily departures to Chicago and four departures to Denver. Northwest AirlinK/Pinnacle Airlines also operates CRJs, with five daily departures to Minneapolis and one departure to Detroit.

The utilization of smaller 50-seat aircraft at Lincoln Airport is a trend that many smaller commercial service airports are experiencing. The CRJs are less expensive to operate and satisfy the desire by passengers to travel in a jet as opposed to a turboprop aircraft. One side effect of this commercial fleet change has been a sharp reduction in

both cargo and mail coming through the airport as these aircraft has smaller cargo carrying capacities.

One additional airline, Allegiant Air, utilizes a 150-seat MD83 aircraft to provide service to and from Las Vegas. Departures are scheduled for Wednesdays and Saturdays.

Origin and Destination

The U.S. Department of Transportation maintains a rolling quarterly survey of 10 percent of all airline tickets sold. This Origin & Destination (O&D) Survey provides information on passengers' starting and ending cities, and shows the volume of traffic between city pairs. The figures do not include through passengers, which would likely be a very small percentage of passengers at Lincoln Airport since all flights are directly linked to hub airports and no feeder routes link to Lincoln Airport.

Table 2E and **Exhibit 2C** present the top twenty O&D markets for Lincoln Airport. In 2000, Washington, D.C. was the top destination market, followed by St. Louis. At the time, TWA provided service to St. Louis, but there was no direct flight to Washington, D.C. Chicago was the fourth most popular O&D market. The top 20 markets in 2000 represented approximately 54 percent of all trips. In 2005, Chicago is the top O&D market, followed by Washington, D.C., Los Angeles, and St. Louis, in descending order. In 2005, the top 20 markets represent more than 76 percent of all trips.

TABLE 2E
Top Twenty Origin-Destination (O-D) Markets, 2000 and 2005
Lincoln Airport

| Rank | 2000 | | | 2005 | | |
|------|--------------------|----------|---------|--------------------|----------|---------|
| | Market | O-D Pax* | Percent | Market | O-D Pax* | Percent |
| 1 | Washington | 27,920 | 9.76% | Chicago | 38,710 | 12.53% |
| 2 | St. Louis | 27,600 | 9.65% | Washington | 31,530 | 10.21% |
| 3 | Los Angeles | 24,130 | 8.43% | Los Angeles | 25,390 | 8.22% |
| 4 | Chicago | 23,570 | 8.24% | St. Louis | 19,870 | 6.43% |
| 5 | New York | 18,340 | 6.41% | New York | 18,600 | 6.02% |
| 6 | Minneapolis | 16,030 | 5.60% | Phoenix | 16,840 | 5.45% |
| 7 | Denver | 15,640 | 5.47% | Minneapolis | 15,300 | 4.95% |
| 8 | Phoenix | 15,490 | 5.41% | San Francisco | 14,040 | 4.55% |
| 9 | San Francisco | 13,700 | 4.79% | Orlando | 13,840 | 4.48% |
| 10 | Seattle | 12,410 | 4.34% | Denver | 13,760 | 4.45% |
| 11 | Orlando | 12,290 | 4.30% | Las Vegas | 13,380 | 4.33% |
| 12 | Detroit | 10,960 | 3.83% | Seattle | 13,080 | 4.23% |
| 13 | Las Vegas | 9,720 | 3.40% | Detroit | 12,120 | 3.92% |
| 14 | San Diego | 9,710 | 3.39% | San Diego | 11,520 | 3.73% |
| 15 | Indianapolis | 9,140 | 3.19% | Atlanta | 8,950 | 2.90% |
| 16 | Portland | 8,190 | 2.86% | Portland | 8,830 | 2.86% |
| 17 | Dallas | 8,060 | 2.82% | Indianapolis | 8,640 | 2.80% |
| 18 | Atlanta | 7,960 | 2.78% | Boston | 8,490 | 2.75% |
| 19 | Nashville | 7,840 | 2.74% | Columbus | 8,080 | 2.62% |
| 20 | Philadelphia | 7,390 | 2.58% | Philadelphia | 7,910 | 2.56% |
| | Top 20 Passengers | 286,090 | | Top 20 Passengers | 308,880 | |
| | Total Passengers | 532,750 | | Total Passengers | 405,834 | |
| | Top 20 O&D Percent | 53.7% | | Top 20 O&D Percent | 76.1% | |

* Pax = Passengers

Source: Airport Records and Department of Transportation O&D Survey

Three of the four non-stop destinations from Lincoln Airport were in the O&D top ten in 2005. Las Vegas, with only recent service available, ranked eleventh. Washington, D.C. was the number two destination in 2005 and number one in 2000, yet has never had non-stop service.

HISTORIC PASSENGER ENPLANEMENTS

Table 2F and **Exhibit 2D** provide a review of the history of total passenger

enplanements at Lincoln Airport from 1986 to the present. Over the past 20 years, Lincoln Airport enplanement activity has fluctuated from a low of 198,000 in 1991, to a high of 283,000 in 1999. The average enplanement level over the previous 20 years has been nearly 241,000. Since 2000, each year has been below the average, with 2005 accounting for 203,000 enplanements.

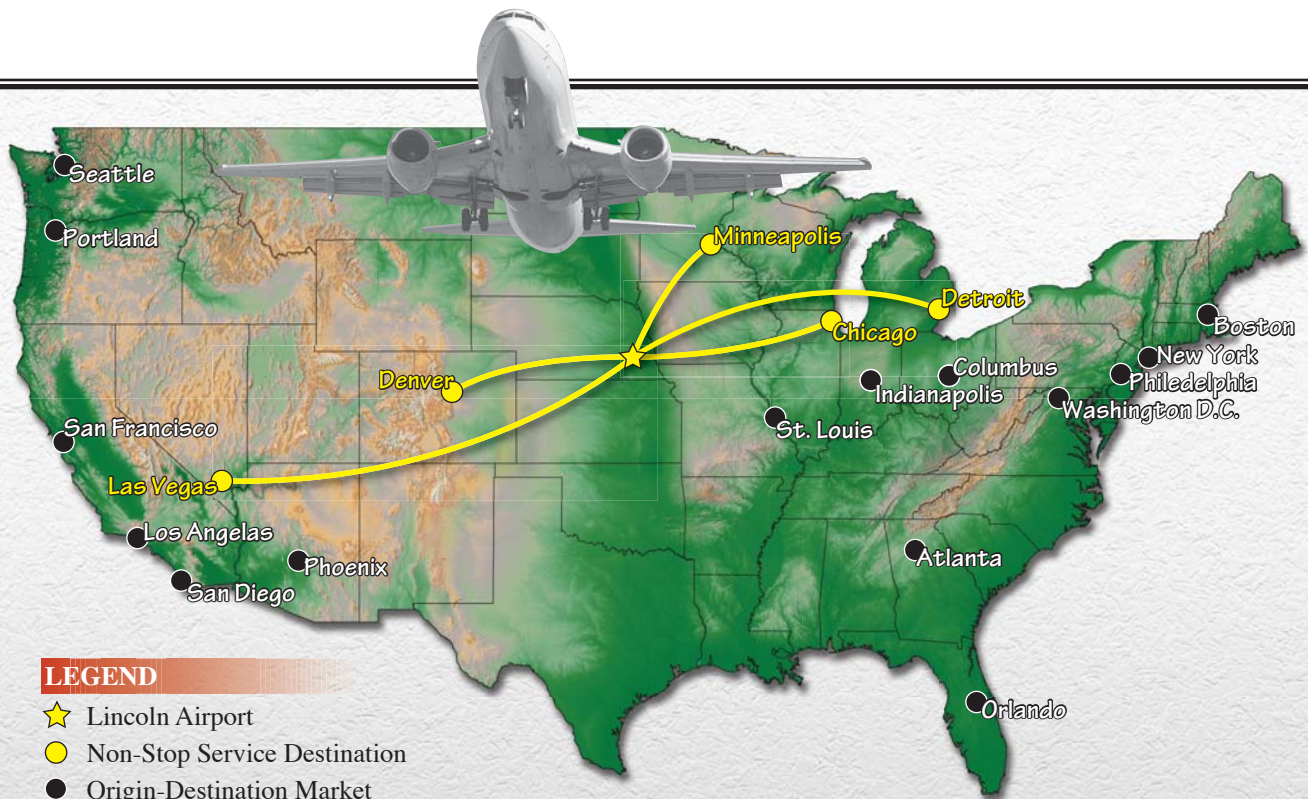

Top 20 Origin-Destination Markets / Non-Stop Service Destinations

1. Chicago
2. Washington D.C.
3. Los Angeles
4. St. Louis
5. New York
6. Phoenix
7. Minneapolis
8. San Francisco
9. Orlando
10. Denver

11. Las Vegas
12. Seattle
13. Detroit
14. San Diego
15. Atlanta
16. Portland
17. Indianapolis
18. Boston
19. Columbus
20. Philadelphia



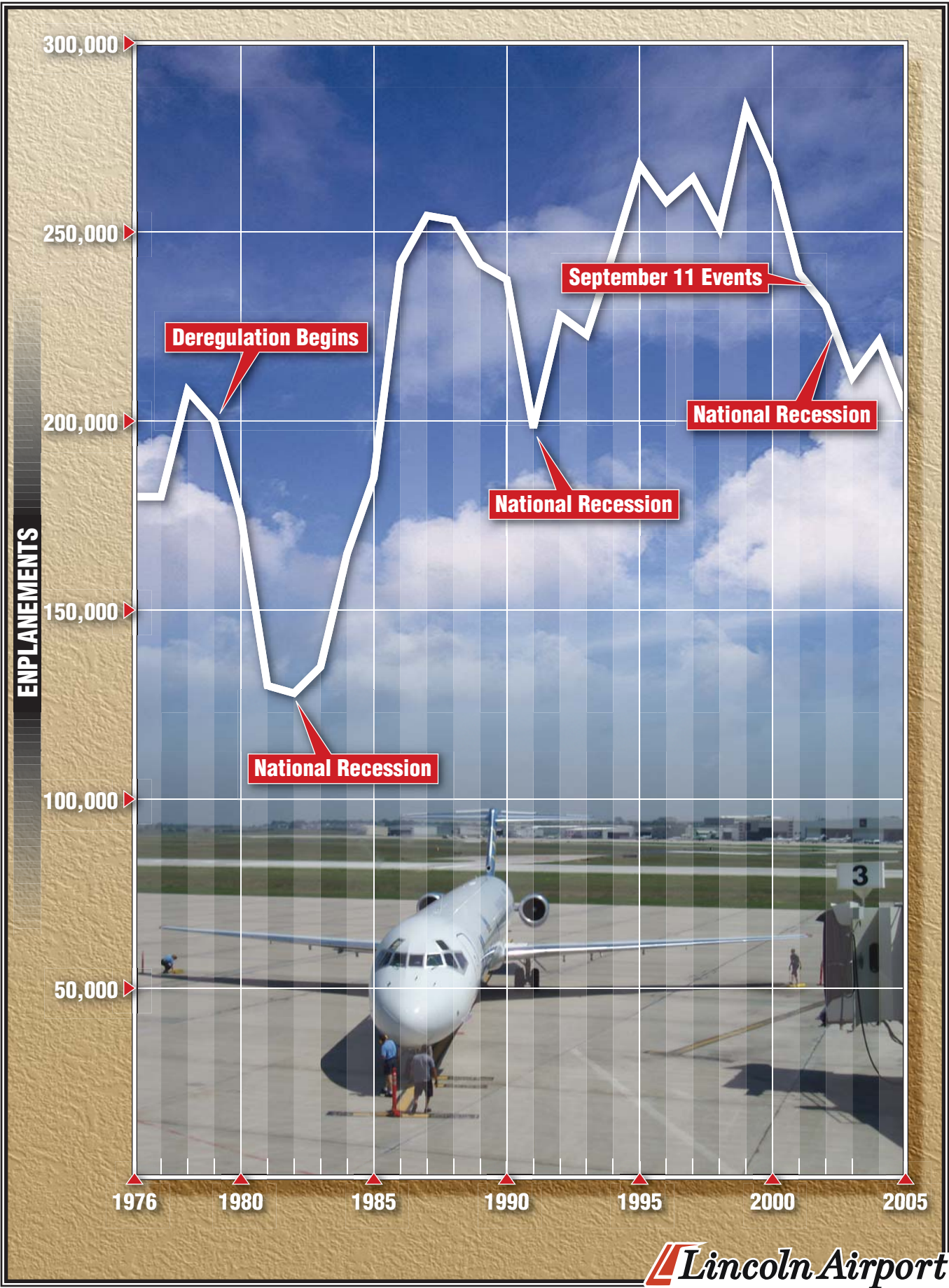

Lincoln Airport

TABLE 2F
Historic Passenger Enplanements
and Percent Change
Lincoln Airport

| Year | Lincoln Enplanements | Percent Change |
|-------------|-----------------------------|-----------------------|
| 1986 | 241,803 | NA |
| 1987 | 254,336 | 5.18% |
| 1988 | 253,096 | -0.49% |
| 1989 | 241,505 | -4.58% |
| 1990 | 237,460 | -1.67% |
| 1991 | 198,196 | -16.53% |
| 1992 | 227,997 | 15.04% |
| 1993 | 222,824 | -2.27% |
| 1994 | 244,383 | 9.68% |
| 1995 | 267,602 | 9.50% |
| 1996 | 257,929 | -3.61% |
| 1997 | 264,317 | 2.48% |
| 1998 | 251,031 | -5.03% |
| 1999 | 282,624 | 12.59% |
| 2000 | 266,375 | -5.75% |
| 2001 | 239,041 | -10.26% |
| 2002 | 230,389 | -3.62% |
| 2003 | 211,594 | -8.16% |
| 2004 | 221,228 | 4.55% |
| 2005 | 202,917 | -8.28% |

Source: Airport Records

As noted on the exhibit, national economic recessions have negatively influenced enplanements at Lincoln Airport. During times of economic prosperity, however, enplanements have thrived. During the 2000s, economic recession coupled with the events of 9/11 have significantly impacted enplanements at Lincoln.

Northwest AirlinK/Pinnacle Airlines and United Express are the dominant carriers operating at Lincoln Airport. Since 2003, Northwest AirlinK has accounted for an average of 33 percent of

total enplanements. United Express has captured approximately 56 percent on average. The large market share is likely the result of many factors including the destinations they serve, the competitive fares offered, and the consistency of service to the airport. Since Allegiant Air began operations in February 2006, they have captured approximately five percent of the enplanements. When American Eagle Airlines was operating, until September 2004, they captured approximately 30 percent of the enplanements. Monthly enplanements by airline, since 2003, are presented in **Table 2G**.

From June 2004 through June 2005, Westward Airways provided service from Scottsbluff, Nebraska, to North Platte, to Lincoln, and on to Omaha. Westward Airways utilized a Pilatus 12 single engine turboprop aircraft with a configuration for nine passenger seats and two pilots. Over the course of their service, the airline enplaned 1,378 passengers at Lincoln Airport.

Exhibit 2E illustrates the monthly moving total enplanements since January 2001. As can be seen, the previous six years of service has generally trended down. Many regional airports have also seen this trend in recent years, but most began to experience the downward trend after the events of September 11, 2001, and during the subsequent national economic recession. The decline of enplanements at Lincoln Airport began in 2000, after the airport's highest enplanement total of 282,000 in 1999.

TABLE 2G
Monthly Enplanements by Airline (January 2003-September 2006)
Lincoln Airport

| | | ENPLANEMENTS | | | | | PERCENT | | | |
|--------------|-------|----------------------|------------------------|----------------------------------|------------------------|----------------|---------------------------|------------------------|----------------------------------|------------------------|
| Year | Month | Northwest Airlink | United Ex- press | Alle- giant/ West- ward | Ameri- can Eagle | Total | North- west Airlink | United Ex- press | Alle- giant/ West- ward | Ameri- can Eagle |
| 2006 | Sept | 5,444 | 8,217 | 721 | 0 | 14,382 | 37.85% | 57.13% | 5.01% | 0.00% |
| 2006 | Aug | 5,625 | 9,270 | 878 | 0 | 15,773 | 35.66% | 58.77% | 5.57% | 0.00% |
| 2006 | July | 6,011 | 10,208 | 1,146 | 0 | 17,365 | 34.62% | 58.78% | 6.60% | 0.00% |
| 2006 | June | 6,240 | 10,544 | 1,049 | 0 | 17,833 | 34.99% | 59.13% | 5.88% | 0.00% |
| 2006 | May | 6,153 | 10,652 | 894 | 0 | 17,699 | 34.76% | 60.18% | 5.05% | 0.00% |
| 2006 | April | 5,125 | 9,863 | 769 | 0 | 10,893 | 47.05% | 45.89% | 7.06% | 0.00% |
| 2006 | Mar | 5,131 | 11,049 | 1,064 | 0 | 17,244 | 29.76% | 64.07% | 6.17% | 0.00% |
| 2006 | Feb | 4,051 | 8,723 | 935 | 0 | 13,709 | 29.55% | 63.63% | 6.82% | 0.00% |
| 2006 | Jan | 4,406 | 9,129 | 0 | 0 | 13,535 | 32.55% | 67.45% | 0.00% | 0.00% |
| TOTAL | | 48,186 | 82,791 | 7,456 | 0 | 138,433 | 35.20% | 59.45% | 5.35% | 0.00% |
| 2005 | Dec | 6,910 | 10,418 | 0 | 0 | 17,328 | 39.88% | 60.12% | 0.00% | 0.00% |
| 2005 | Nov | 6,408 | 9,179 | 0 | 0 | 15,587 | 41.11% | 58.89% | 0.00% | 0.00% |
| 2005 | Oct | 7,506 | 10,003 | 0 | 0 | 17,509 | 42.87% | 57.13% | 0.00% | 0.00% |
| 2005 | Sept | 7,090 | 9,976 | 0 | 0 | 17,066 | 41.54% | 58.46% | 0.00% | 0.00% |
| 2005 | Aug | 6,680 | 10,358 | 0 | 0 | 17,038 | 39.21% | 60.79% | 0.00% | 0.00% |
| 2005 | July | 7,261 | 11,247 | 0 | 0 | 18,508 | 39.23% | 60.77% | 0.00% | 0.00% |
| 2005 | June | 8,539 | 11,083 | 120 | 0 | 19,742 | 43.25% | 56.14% | 0.61% | 0.00% |
| 2005 | May | 8,047 | 10,511 | 119 | 0 | 18,677 | 43.09% | 56.28% | 0.64% | 0.00% |
| 2005 | April | 6,759 | 8,272 | 112 | 0 | 15,143 | 44.63% | 54.63% | 0.74% | 0.00% |
| 2005 | Mar | 6,358 | 9,621 | 124 | 0 | 16,103 | 39.48% | 59.75% | 0.77% | 0.00% |
| 2005 | Feb | 5,004 | 8,431 | 94 | 0 | 13,529 | 36.99% | 62.32% | 0.69% | 0.00% |
| 2005 | Jan | 5,250 | 8,927 | 101 | 0 | 14,278 | 36.77% | 62.52% | 0.71% | 0.00% |
| TOTAL | | 81,812 | 118,026 | 670 | 0 | 200,508 | 40.67% | 58.98% | 0.35% | 0.00% |
| 2004 | Dec | 6,722 | 10,415 | 106 | 0 | 17,243 | 38.98% | 60.40% | 0.61% | 0.00% |
| 2004 | Nov | 6,532 | 9,226 | 125 | 0 | 15,883 | 41.13% | 58.09% | 0.79% | 0.00% |
| 2004 | Oct | 6,817 | 10,576 | 119 | 0 | 17,512 | 38.93% | 60.39% | 0.68% | 0.00% |
| 2004 | Sept | 5,805 | 10,176 | 101 | 401 | 16,483 | 35.22% | 61.74% | 0.61% | 2.43% |
| 2004 | Aug | 5,464 | 10,301 | 83 | 2,304 | 18,152 | 30.10% | 56.75% | 0.46% | 12.69% |
| 2004 | July | 5,918 | 11,740 | 77 | 2,864 | 20,599 | 28.73% | 56.99% | 0.37% | 13.90% |
| 2004 | June | 6,232 | 13,058 | 97 | 3,245 | 22,632 | 27.54% | 57.70% | 0.43% | 14.34% |
| 2004 | May | 5,645 | 13,166 | 0 | 2,553 | 21,364 | 26.42% | 61.63% | 0.00% | 11.95% |
| 2004 | April | 4,472 | 11,292 | 0 | 2,295 | 18,059 | 24.76% | 62.53% | 0.00% | 12.71% |
| 2004 | Mar | 4,833 | 12,391 | 0 | 2,700 | 19,924 | 24.26% | 62.19% | 0.00% | 13.55% |
| 2004 | Feb | 3,826 | 10,370 | 0 | 2,339 | 16,535 | 23.14% | 62.72% | 0.00% | 14.15% |
| 2004 | Jan | 3,767 | 8,899 | 0 | 2,256 | 14,922 | 25.24% | 59.64% | 0.00% | 15.12% |
| TOTAL | | 66,033 | 131,610 | 708 | 20,957 | 219,308 | 30.37% | 60.06% | 0.33% | 9.24% |
| 2003 | Dec | 4,919 | 10,418 | 0 | 2,939 | 18,276 | 26.92% | 57.00% | 0.00% | 16.08% |
| 2003 | Nov | 4,705 | 9,578 | 0 | 2,734 | 17,017 | 27.65% | 56.28% | 0.00% | 16.07% |
| 2003 | Oct | 4,759 | 10,367 | 0 | 4,925 | 20,051 | 23.73% | 51.70% | 0.00% | 24.56% |
| 2003 | Sept | 4,255 | 8,861 | 0 | 4,634 | 17,750 | 23.97% | 49.92% | 0.00% | 26.11% |
| 2003 | Aug | 4,978 | 8,357 | 0 | 4,881 | 18,216 | 27.33% | 45.88% | 0.00% | 26.80% |
| 2003 | July | 5,183 | 7,766 | 0 | 5,618 | 18,567 | 27.92% | 41.83% | 0.00% | 30.26% |
| 2003 | June | 5,322 | 7,598 | 0 | 5,299 | 18,219 | 29.21% | 41.70% | 0.00% | 29.09% |
| 2003 | May | 4,737 | 7,886 | 0 | 5,156 | 17,779 | 26.64% | 44.36% | 0.00% | 29.00% |
| 2003 | April | 3,984 | 7,445 | 0 | 4,308 | 15,737 | 25.32% | 47.31% | 0.00% | 27.37% |
| 2003 | Mar | 4,673 | 7,389 | 0 | 4,818 | 16,880 | 27.68% | 43.77% | 0.00% | 28.54% |
| 2003 | Feb | 3,622 | 6,764 | 0 | 4,363 | 14,749 | 24.56% | 45.86% | 0.00% | 29.58% |
| 2003 | Jan | 3,499 | 7,151 | 0 | 4,413 | 15,063 | 23.23% | 47.47% | 0.00% | 29.30% |
| TOTAL | | 54,636 | 99,580 | 0 | 54,088 | 208,304 | 26.18% | 47.76% | 0.00% | 26.06% |

Source: Airport Records

PASSENGER ENPLANEMENTS



FACTORS AFFECTING ENPLANEMENT LEVELS

Since 9/11, airlines began operating in a more cost-conscious manner in order to compete with low-cost carriers. Legacy carriers such as United and American began replacing large jet aircraft, serving smaller markets with regional jets. This allowed the airlines to lower operating costs while increasing the board loading factor (BLF). The BLF is the ratio of seats sold versus seats available.

Another major factor impacting the Lincoln Airport enplanements was the transition when TWA was acquired by American Airlines. TWA had been operating DC-9s as well as regional jets at Lincoln Airport prior to the acquisition. American Airlines took over operations in December 2001 and immediately began utilizing regional jets and turboprop aircraft under the regional carrier American Connection (American Eagle). In September 2004, American discontinued all service to Lincoln Airport.

United Airlines has also transitioned service at Lincoln Airport, from mainline service utilizing 727, 737, 757 aircraft, to its regional carrier United Express. By June 2001, this transition was complete and only regional jet service was available through United Express. The loss of service by the legacy carriers utilizing larger aircraft has contributed to the drop in enplanement levels at Lincoln Airport. As a direct result, Omaha's Eppley Airfield has become more at-

tractive, as they have offered consistent service by the legacy carriers and new service from low-cost carriers.

A comparison of note with Omaha Eppley Airfield is the fact that enplanements at Lincoln Airport increased in the late 1990s, even after low-cost carriers were operating in Omaha. In May of 1994, Midwest Express established a secondary hub at Omaha, offering direct service to both coasts as well as service to their primary hub in Milwaukee. Between 1994 and 1995, enplanements at Omaha increased by 20 percent, or 290,000, reaching a total of 1.5 million enplanements. In 1995, both Southwest and Frontier Airlines began service and enplanements rose an additional 15 percent, adding another 260,000 enplanements.

During this time, enplanements at Lincoln Airport actually increased from 245,000 in 1994, to 268,000 in 1995. By 1999, Lincoln reached a historic high enplanement level of 283,000. Since 1999, enplanements have been down at Lincoln, while they have increased at Omaha to more than two million in 2005. It appears that the introduction of low-cost carriers at Omaha is not the primary factor negatively affecting enplanement levels at Lincoln. Instead, the loss of mainline carriers United and TWA/American and the accompanying fleet mix change from larger jets to regional jets has had a significant impact on enplanement levels at Lincoln Airport. In addition, the number of non-stop destinations has decreased.

Omaha Eppley Airfield will continue to have an effect on enplanement levels at Lincoln Airport. Omaha does offer service to 19 non-stop destinations, and has service from both mainline carriers and low-cost carriers. Overall, enplanement levels have also been increasing. But the most significant change to service at Lincoln Airport has been the replacement of the mainline carriers by the regional carriers, the loss of destinations, and the loss of service completely by American Airlines.

ENPLANEMENT FORECAST

As discussed in this chapter's introduction, the first steps involved in updating an airport's forecasts include reviewing previous forecasts in comparison to actual activity, to determine what changes, if any, may be necessary. After that comes the consideration of the effects of any potential new

factors that could affect the forecasts, such as changes in the socioeconomic climate, or the potential effects of low-cost service at other airports or at Lincoln.

Previous Enplanement Forecasts

Several previous forecasts were reviewed and are outlined in **Table 2H**. These include projections from the previous 1998 master plan, as well as from the FAA *Terminal Area Forecasts* (TAF), published in 1996 and 2006. The 2006 TAF is the FAA's most current forecast of activity for Lincoln Airport. The TAF was released in early 2006 and is considered for comparative purposes. The FAA TAF is aligned with the federal fiscal year which begins October 1. The FAA TAF used fiscal year 2004 as its base year for enplanement forecasts for Lincoln Airport.

TABLE 2H
Comparative Enplanement Forecasts
Lincoln Airport

| | 1995 | 2000 | 2005 | 2010 | 2015 | 2020 | 2025 |
|---------------------|---------|---------|---------|---------|---------|---------|---------|
| Actual Enplanements | 267,602 | 266,375 | 202,917 | | | | |
| 1998 Master Plan | | 285,000 | 325,000 | 375,000 | | 500,000 | |
| 2006 FAA TAF | 260,097 | 269,521 | 225,613 | 251,927 | 281,338 | 314,210 | 350,951 |
| 1996 FAA TAF | | 324,150 | 380,362 | 463,268 | | | |

As can be seen from the table, actual enplanement traffic has remained below the previous two master plan forecasts as well as the FAA TAF forecasts. The 2006 FAA TAF projections have the benefit of being prepared most recently, thus consider more-recent enplanement activity. The average annual growth rate projected

through 2025 by the 2006 TAF is 2.23 percent. This is slightly below the growth rate of 2.41 percent experienced nationwide from 1995 to 2005. It is also below the national forecast enplanement growth rate of 2.47 percent from 2006 through 2017. The following section will consider the industry trends as well as local socioeco-

conomic factors for comparison to the FAA TAF.

Comparable Market Analysis

There are a variety of local factors that affect the potential for passengers

within a Metropolitan Statistical Area (MSA). The MSA for Lincoln encompasses the whole of Lancaster County. The ratio of enplanements to population is termed the Travel Propensity Factor (TPF). **Table 2J** presents a historical review of the TPF for Lincoln Airport since 1980.

| Year | Lincoln Enplanements | Lancaster Population | Travel Propensity Factor |
|-------------|-----------------------------|-----------------------------|---------------------------------|
| 1980 | 197,906 | 193,700 | 1.0217 |
| 1985 | 190,477 | 202,280 | 0.9417 |
| 1990 | 237,460 | 213,641 | 1.1115 |
| 1995 | 267,602 | 234,280 | 1.1422 |
| 1996 | 257,929 | 237,610 | 1.0855 |
| 1997 | 264,317 | 241,150 | 1.0961 |
| 1998 | 251,031 | 244,590 | 1.0263 |
| 1999 | 282,624 | 247,440 | 1.1422 |
| 2000 | 266,375 | 251,152 | 1.0606 |
| 2001 | 239,041 | 253,183 | 0.9441 |
| 2002 | 230,389 | 256,374 | 0.8986 |
| 2003 | 211,594 | 260,047 | 0.8137 |
| 2004 | 221,228 | 261,742 | 0.8452 |
| 2005 | 202,917 | 264,814 | 0.7663 |

As noted in the table, in 2005 the Lincoln Airport TPF was at 0.7663, a 25-year low. The highest recorded TPF was 1.1422 in 1999. From 1980 to 1999, the Lincoln TPF averaged 1.0217, while from 2000 to 2005 the TPF declined, averaging 0.8881.

The TPF is predominantly impacted by the proximity of an airport to other regional airports with higher levels of service or “hub” airports. Regional airports with higher TPF ratios tend to be located further from hub airports, in relatively isolated areas. These airports generally have a ser-

vice area that extends into adjacent, well-populated regions, or have some type of air service advantage that attracts more of those passengers that might otherwise chose the hub airport.

For comparison purposes, 11 MSAs with similar characteristics to the Lincoln MSA were analyzed. This analysis is presented in **Table 2K**. Each of these MSAs is served by a regional airport with scheduled commercial service, and has a significant University presence and/or is the state capital. Each is within a manageable driving distance to a larger hub airport.

TABLE 2K
Comparable Market Analysis
Lincoln Airport

| | 2000 | | | 2005 | | | Miles to Hub Airport |
|---------------------------|----------------|----------------|---------------|----------------|----------------|---------------|---------------------------------|
| | MSA Population | Enplanements | TPF | MSA Population | Enplanements | TPF | |
| COMPARABLE MARKETS | | | | | | | |
| College Station, TX | 185,110 | 90,736 | 0.4902 | 189,740 | 73,584 | 0.3878 | 80 - Houston |
| Columbia, MO | 145,950 | 32,604 | 0.2234 | 153,280 | 22,821 | 0.1489 | 120 - St. Louis |
| Waco, TX | 213,517 | 63,365 | 0.2968 | 219,763 | 65,213 | 0.2967 | 90 - Dallas/Fort Worth |
| Peoria, IL | 366,670 | 196,005 | 0.5346 | 369,160 | 222,213 | 0.6019 | 40 - Bloomington |
| Evansville, IN | 343,010 | 253,894 | 0.7402 | 349,540 | 220,027 | 0.6295 | 120 - Louisville |
| Bloomington/Normal, IL | 150,860 | 230,419 | 1.5274 | 159,010 | 211,590 | 1.3307 | 40 - Peoria 60 - Springfield |
| Lansing, MI | 448,340 | 339,912 | 0.7582 | 455,320 | 299,037 | 0.6568 | 90 - Detroit |
| Tallahassee, FL | 320,930 | 459,514 | 1.4318 | 334,890 | 611,881 | 1.8271 | 160 - Jacksonville |
| Baton Rouge, LA | 707,390 | 417,366 | 0.5900 | 733,800 | 431,582 | 0.5881 | 60 - New Orleans |
| Cedar Rapids, IA | 237,800 | 485,629 | 2.0422 | 246,410 | 476,785 | 1.9349 | 120 - Des Moines |
| Madison, WI | 503,770 | 663,354 | 1.3168 | 537,040 | 851,643 | 1.5858 | 75 - Milwaukee |
| COMBINED AVERAGE | 329,395 | 293,891 | 0.9047 | 340,723 | 316,943 | 0.9080 | |
| Lincoln, NE | 251,152 | 266,375 | 1.0606 | 264,814 | 202,917 | 0.7663 | |

In 2000, the average TPF of the airports serving the eleven selected MSAs was 0.9047. This figure remained nearly the same in 2005, increasing only slightly to 0.9080. Of the MSAs presented, three showed an increase in TPF, with only Tallahassee, Florida, and Madison, Wisconsin, showing significant increases.

The increase in TPF for Tallahassee is likely the result of the remoteness of the city. The closest city with significant air carrier service and a low-cost carrier is Jacksonville, Florida, located approximately 160 miles to the east. Tampa is even further, approximately 180 miles to the south. With Tallahassee being the state capital and Florida State University located there, Tallahassee Regional Airport will likely continue to capture market share from a large area.

Madison has also shown TPF growth over the last five years, increasing from 1.3168 in 2000 to 1.5858 in 2005.

Madison is the state capital and is home to the University of Wisconsin. Dane County Regional Airport, which serves the Madison MSA, offers 15 non-stop flights to locations as diverse as Atlanta, Cincinnati, Denver, New York and Washington, D.C., as well as Chicago, Detroit, and Dallas. The available flights are more diverse than those offered by Lincoln Airport.

The Bloomington/Normal, Illinois, MSA is home to the University of Illinois and is 60 miles to the northeast of the state capital at Springfield. The airport, Central Illinois Regional, experienced a TPF of 1.3307 in 2005, with an MSA population of only 150,000. It seems clear that Central Illinois Regional Airport, serving the Bloomington/Normal MSA, offers amenities that draw enplanements from beyond its MSA. The airport offers low-cost service by AirTran to both Atlanta and Orlando. Delta Connection also offers service to Atlanta. In addition, service is offered to

Detroit by Northwest AirlinK and to Chicago by both United Express and American Eagle. This service exceeds that offered by both the Greater Peoria Regional Airport and the Abraham Lincoln Airport at Springfield.

The average TPF of the selected MSAs, with both Tallahassee and Madison removed, decreased from 0.8003 in 2000, to 0.7306 in 2005. This average reveals that the trend has been for regional airports to lose TPF, and thus enplanements, over the previous five years. Factors such as the proximity to other air carrier airports, particularly those with low-cost carriers such as AirTran or Southwest, have significantly impacted regional airports. The low-cost airlines tend to attract travelers from a wider area than the legacy carriers.

Lincoln Airport does provide a good airline schedule with convenient and desirable departure/arrival times, however, analysis of airline seats available, to be presented later, indicates that most aircraft are filled to 70 percent capacity on average. Typically, the last seats sold on the airplane cost more than those purchased first. Higher seat costs coupled with the opportunity to drive one hour to Omaha Eppley Airfield, an airport with higher levels of service, are significant factors that pull potential passengers away from Lincoln.

The Lincoln Airport TPF appears to have decreased more than the average of the selected MSAs and more than the individual MSAs. The Lansing, Michigan TPF, for example, is 0.6568. Lansing is the capital of Michigan and home to Michigan State University.

Detroit Metro Wayne County Airport is 90 miles to the southeast, connected directly by Interstate 96. The Lansing MSA population is twice as large as the Lincoln MSA, but the TPFs are similar. Lansing only decreased from a TPF of 0.7582 in 2000, to 0.6568 in 2005.

The average decline in TPF of those MSAs that experienced a decrease from 2000 to 2005 was only 0.0697. Lincoln Airport experienced a decrease of 0.2944. It appears that Lincoln is experiencing a greater decline in TPF than other airports with similar characteristics. This knowledge is considered when determining reasonable enplanement forecasts.

Market Share of Domestic Enplanements

The first forecasting method examined was the airport's historic market share of U.S. domestic enplanements. National forecasts of U.S. domestic enplanements are compiled each year by the FAA and consider the state of the economy, fuel prices, and prior year developments. According to the most recent publication, *FAA Aerospace Forecasts, Fiscal Years 2006-2017*, domestic passenger enplanements are forecast to increase at an average annual rate of 3.1 percent over the 12-year forecast period.

Two enplanement forecasts have been developed as a market share percent of national enplanement forecasts, as shown in **Table 2L**. The first considers the airport maintaining its 2005 percent of national enplanements. As

has been shown, the trend at the airport has been a decreasing market share, thus, this forecast would represent a high-end forecast and a return to historic levels. This forecast results in 229,910 enplanements in 2010; 269,142 enplanements in 2015, and 359,064 enplanements in 2025.

The second forecast considers a slight market share reduction in enplanements as a percent of national enplanements. This has been the trend at the airport over the previous twenty years. This forecast results in 223,876 enplanements in 2010, 257,636 enplanements in 2015, and 331,861 enplanements in 2025.

| TABLE 2L Market Share of U.S. Enplanements Lincoln Airport | | | | | |
|--|--|--------------------------------------|-----------------------------|---|-------------------------------------|
| Year | U.S. Domestic Enplanements (millions) | U.S. Year to Year Growth Rate | Lincoln Enplanements | Lincoln Year-to-Year Growth Rate | LNK Market Share of National |
| 1986 | 404.7 | NA | 241,803 | NA | 0.0597% |
| 1987 | 441.2 | 9.02% | 254,336 | 5.18% | 0.0576% |
| 1988 | 441.2 | 0.00% | 253,096 | -0.49% | 0.0574% |
| 1989 | 443.6 | 0.54% | 241,505 | -4.58% | 0.0544% |
| 1990 | 456.6 | 2.93% | 237,460 | -1.67% | 0.0520% |
| 1991 | 445.9 | -2.34% | 198,196 | -16.53% | 0.0444% |
| 1992 | 463.2 | 3.88% | 227,997 | 15.04% | 0.0492% |
| 1993 | 468.5 | 1.14% | 222,824 | -2.27% | 0.0476% |
| 1994 | 509.0 | 8.64% | 244,383 | 9.68% | 0.0480% |
| 1995 | 527.8 | 3.69% | 267,602 | 9.50% | 0.0507% |
| 1996 | 555.6 | 5.27% | 257,929 | -3.61% | 0.0464% |
| 1997 | 578.3 | 4.09% | 264,317 | 2.48% | 0.0457% |
| 1998 | 589.3 | 1.90% | 251,031 | -5.03% | 0.0426% |
| 1999 | 611.2 | 3.72% | 282,624 | 12.59% | 0.0462% |
| 2000 | 641.2 | 4.91% | 266,375 | -5.75% | 0.0415% |
| 2001 | 626.8 | -2.25% | 239,041 | -10.26% | 0.0381% |
| 2002 | 574.5 | -8.34% | 230,389 | -3.62% | 0.0401% |
| 2003 | 587.8 | 2.32% | 211,594 | -8.16% | 0.0360% |
| 2004 | 628.5 | 6.92% | 221,228 | 4.55% | 0.0352% |
| 2005 | 669.8 | 6.57% | 202,917 | -8.28% | 0.0303% |
| CONSTANT SHARE OF 2005 MARKET SHARE | | | | | |
| 2010 | 758.9 | 3.15% | 229,910 | 2.53% | 0.0303% |
| 2015 | 888.4 | 2.83% | 269,142 | 3.20% | 0.0303% |
| 2025 | 1,185.2 | 2.83% | 359,064 | 2.92% | 0.0303% |
| DECREASING SHARE FORECAST | | | | | |
| 2010 | 758.9 | 3.15% | 223,876 | 1.99% | 0.0295% |
| 2015 | 888.4 | 2.83% | 257,636 | 2.85% | 0.0290% |
| 2025 | 1,185.2 | 2.83% | 331,861 | 2.56% | 0.0280% |
| <i>U.S. Enplanements and projections from FAA Aerospace Forecasts 2006-2017, interpolation of data by Coffman Associates</i> | | | | | |

Travel Propensity Factor

The next forecasting method is to compare the historic relationship between the population of the airport service area (Lancaster County) and the airport enplanement levels or TPF as described earlier. As population increases, it is reasonable to expect the need and demand for commercial service to grow. Lincoln Airport provides a level of convenience to the residents of Lancaster County that cannot be readily met by other airports. Thus, it is reasonable to assume that Lincoln Airport could become more attractive to local travelers. This would be especially true if the airport were able to attract another carrier providing non-stop service to hub not currently served di-

rectly or direct service to a top-10 O & D market.

From 1996 to 2000, Lincoln Airport realized a TPF ratio of at least one enplanement per 1,000 residents in Lancaster County. Every year since 2001, the ratio has decreased, reaching a historic low ratio of 0.7663 in 2005.

Three enplanement forecasts were developed utilizing the TPF, shown below in **Table 2M**. The first forecast considers the airport maintaining a constant share TPF in Lancaster County. This constant share is based on maintaining the 0.77 ratio from 2005. This forecast results in 226,372 enplanements in 2010, 246,780 in 2015 and 294,125 in 2025.

| TABLE 2M | | | |
|--|------------------------------------|-----------------------------|---------------------------------|
| Market Share of Lincoln Travel Propensity | | | |
| Lincoln Airport | | | |
| Year | Lancaster County Population | Lincoln Enplanements | Travel Propensity Factor |
| 1996 | 237,610 | 257,929 | 1.09 |
| 1997 | 241,150 | 264,317 | 1.10 |
| 1998 | 244,590 | 251,031 | 1.03 |
| 1999 | 247,440 | 282,624 | 1.14 |
| 2000 | 251,152 | 266,375 | 1.06 |
| 2001 | 253,183 | 239,041 | 0.94 |
| 2002 | 256,374 | 230,389 | 0.90 |
| 2003 | 260,047 | 211,594 | 0.81 |
| 2004 | 261,742 | 221,228 | 0.85 |
| 2005 | 264,814 | 202,917 | 0.77 |
| CONSTANT SHARE OF 2005 POPULATION | | | |
| 2010 | 295,423 | 226,372 | 0.77 |
| 2015 | 322,057 | 246,780 | 0.77 |
| 2025 | 383,844 | 294,125 | 0.77 |
| RECAPTURE 10 YEAR TPF AVERAGE | | | |
| 2010 | 295,423 | 241,213 | 0.82 |
| 2015 | 322,057 | 279,223 | 0.87 |
| 2025 | 383,844 | 371,510 | 0.97 |
| DECREASING SHARE | | | |
| 2010 | 295,423 | 226,372 | 0.77 |
| 2015 | 322,057 | 238,322 | 0.74 |
| 2025 | 383,844 | 272,529 | 0.71 |

A second forecast considers the possibility of the airport recapturing the previous 10-year average TPF. This assumes a gradual increase in TPF from 0.82 percent in the short term to 0.97 in the long term. This forecast results in 241,213 enplanements in 2010; 279,223 enplanements in 2015; and 371,510 enplanements in 2025.

The final TPF forecast considers a decreasing share, which is reflective of the most recent five-year trend. This forecast would continue the trend at the airport over the previous six years, but slow the trend somewhat so that increases in actual enplanement figures are realized. The forecast results in 226,372 enplanements in 2010, 238,322 enplanements in 2015, and 272,529 enplanements in 2025.

Regression Analysis

Several analytical techniques were examined for their applicability to projecting airline enplanements at Lincoln Airport. These include time-series extrapolation and regression analysis (using several variables). While the potential timeframes used in regression and time series analysis can be endless, the experience of the consultant was used to narrow the potential variables to those that reflect recent trends at the airport.

Time-series analysis of airline enplanements was prepared based upon historic enplanements between 1986 and 2005. The correlation coefficient (r^2) was determined to be 0.029. A second time series regression was conducted upon historic enplanements be-

tween 1996 and 2005. This resulted in a correlation coefficient of 0.69.

The acceptability of the regression is based upon the correlation between the data. Neither of the time-series regressions resulted in an acceptable r^2 value. This result is not entirely unexpected as the airport has experienced a downward enplanement trend. As a result, neither time-series regression was used for forecasting.

A number of additional regressions that compared both local and national variables to enplanements at Lincoln Airport were conducted. National variables included national enplanement levels, available airline seat miles, and gross domestic product. Local variables included population, employment and per capita personal income for both Lancaster County and Nebraska. These analyses yielded correlation coefficients well below reasonable levels, consequently none of these were used in enplanement projections.

ENPLANEMENT FORECAST SUMMARY

A total of five new enplanement forecasts have been developed. Three enplanement forecasts previously developed from the FAA TAF and Airport Master Plan have also been consulted. The trend at Lincoln Airport over the previous six years has been one of declining enplanement levels. Other MSAs with similar characteristics to the Lincoln MSA are also experiencing declining enplanements, although not to the level of Lincoln.

Many factors have contributed to this declining trend at Lincoln Airport. Lincoln is located only 55 miles from Omaha Eppley Airfield. Omaha offers non-stop service to 19 destinations including seven of the top 10 Origin/Destination markets for Lincoln passengers. Markets served by Omaha include Chicago, Washington, D.C., St. Louis, New York, Phoenix, Atlanta, Detroit, Denver, and Minneapolis. In addition, low-cost Southwest Airlines offers service from Omaha.

The airline industry has developed a term called the Southwest Factor to describe what happens to enplanement levels when Southwest serves a city. First, enplanements tend to increase dramatically and second, the service area of the airport is enlarged. Passengers are more inclined to travel up to three hours by car in order to take advantage of lower fares offered by Southwest and other low fare airlines.

Other factors affecting the enplanement levels would be the limited non-stop destinations and a lack of service to some of its highest demand markets such as Washington, D.C. Lincoln Airport has also experienced a significant shift in aircraft fleet mix over the previous six years. While all turbo-prop have been replaced and upgraded with regional jets, the use of larger 727, 737, and 757 aircraft have also been replaced with regional jets. This fleet mix change limits the destinations that can be offered.

Table 2N compares all enplanement forecasts considered. These forecasts

are also depicted on **Exhibit 2F**. As can be seen in the table, the Travel Propensity Factor (TPF) has been declining since the high of 1.1422 in 1999. In 2005, the TPF was 0.7663, the lowest in the last 25 years.

For the past 10 years, the airline industry has experienced significant changes that directly affect Lincoln Airport. The most significant change has been the impact of low-cost carriers on smaller regional airports. The strategy of the low-cost carriers has been to increase their board loading factor (i.e., fill the seats available) with much lower fares than the legacy carriers. One result of this strategy has been a noticeable increase in the service area.

Passengers are inclined to drive significant distances, sometimes up to three hours, in order to take advantage of the lower fares. The convenience of a local regional airport becomes less important. As a result, the service offered from Omaha Eppley Airfield, in particular, is very attractive to travelers from Lincoln and beyond.

The stagnant or downward trend of enplanements at Lincoln Airport is indicative of what is happening at many regional airports across the country. Efforts to add flights or diversify destinations are the ultimate decision of the airlines, and the Airport Authority has little power to increase schedules. For example, the airport is currently served by Allegiant Air which offers twice weekly service to Las Vegas. This route has been very successful as most flights are more than 80 percent

filled. Persuading Allegiant Air to offer additional flights to Las Vegas or to other destination cities may be dif-

icult as there is a smaller catchment area from which to draw passengers.

| TABLE 2N | | | | | |
|---|-----------------------------|--|--|-------------------------------|---------------------------------------|
| Enplanement Forecast Summary | | | | | |
| Lincoln Airport | | | | | |
| Year | Lincoln Enplanements | U.S. Domestic Enplanements (millions) | Market Share of U.S. Enplanements | Lincoln MSA Population | Travel Propensity Factor (TPF) |
| 1996 | 257,929 | 555.6 | 0.0464% | 237,610 | 1.0855 |
| 1997 | 264,317 | 578.3 | 0.0457% | 241,150 | 1.0961 |
| 1998 | 251,031 | 589.3 | 0.0426% | 244,590 | 1.0263 |
| 1999 | 282,624 | 611.2 | 0.0462% | 247,440 | 1.1422 |
| 2000 | 266,375 | 641.2 | 0.0415% | 251,152 | 1.0606 |
| 2001 | 239,041 | 626.8 | 0.0381% | 253,183 | 0.9441 |
| 2002 | 230,389 | 574.5 | 0.0401% | 256,374 | 0.8986 |
| 2003 | 211,594 | 587.8 | 0.0360% | 260,047 | 0.8137 |
| 2004 | 221,228 | 628.5 | 0.0352% | 261,742 | 0.8452 |
| 2005 | 202,917 | 669.8 | 0.0303% | 264,814 | 0.7663 |
| CONSTANT SHARE OF 2005 U.S. ENPLANEMENTS | | | | | |
| 2010 | 229,910 | 758.9 | 0.0303% | 295,423 | 0.7782 |
| 2015 | 269,142 | 888.4 | 0.0303% | 322,057 | 0.8357 |
| 2025 | 359,058 | 1,185.2 | 0.0303% | 383,844 | 0.9354 |
| DECREASING SHARE OF U.S. ENPLANEMENTS | | | | | |
| 2010 | 223,876 | 758.9 | 0.0295% | 295,423 | 0.7578 |
| 2015 | 257,636 | 888.4 | 0.0290% | 322,057 | 0.8000 |
| 2025 | 331,856 | 1,185.2 | 0.0280% | 383,844 | 0.8646 |
| CONSTANT TPF | | | | | |
| 2010 | 226,372 | 758.9 | 0.0298% | 295,423 | 0.7663 |
| 2015 | 246,780 | 888.4 | 0.0278% | 322,057 | 0.7663 |
| 2025 | 294,125 | 1,185.2 | 0.0248% | 383,844 | 0.7663 |
| RECAPTURE 10 YEAR TPF AVERAGE | | | | | |
| 2010 | 241,213 | 758.9 | 0.0318% | 295,423 | 0.8165 |
| 2015 | 279,223 | 888.4 | 0.0314% | 322,057 | 0.8670 |
| 2025 | 371,510 | 1,185.2 | 0.0313% | 383,844 | 0.9679 |
| DECREASING TPF | | | | | |
| 2010 | 227,476 | 758.9 | 0.0300% | 295,423 | 0.7700 |
| 2015 | 238,322 | 888.4 | 0.0268% | 322,057 | 0.7400 |
| 2025 | 272,529 | 1,185.2 | 0.0230% | 383,844 | 0.7100 |
| 1998 AIRPORT MASTER PLAN* | | | | | |
| 2010 | 375,000 | 758.9 | 0.0494% | 295,423 | 1.2694 |
| 2015 | 433,013 | 888.4 | 0.0487% | 322,057 | 1.3445 |
| 2025 | 577,350 | 1,185.2 | 0.0487% | 383,844 | 1.5041 |
| 2006 FAA TAF/SELECTED FORECAST | | | | | |
| 2010 | 251,927 | 758.9 | 0.0332% | 295,423 | 0.8528 |
| 2015 | 281,388 | 888.4 | 0.0317% | 322,057 | 0.8737 |
| 2025 | 350,951 | 1,185.2 | 0.0296% | 383,844 | 0.9143 |

* Interpolated and extrapolated by Coffman Associates

Other scheduling improvements could be made by Northwest Airlinck and United Express. For example, it might make sense for either of these existing operators to provide a direct

flight to Washington, D.C., as it is the number two destination market for passengers enplaning at Lincoln. Unfortunately, those enplaning at Lincoln destined for Washington, D.C.,

ENPLANEMENTS

400,000
350,000
300,000
250,000
200,000
150,000
100,000
50,000

Historical

Forecast

LEGEND

- Constant Share of 2005 U.S. Enplanements
- Decreasing Share of U.S. Enplanements
- Constant TPF
- Constant TPF (10 year average/gradual recapture)
- Decreasing TPF
- 2006 TAF/Selected Forecast

1985 1990 1995 2000 2005 2010 2015 2020 2025



Lincoln Airport

are already utilizing both of these airlines to reach their ultimate destination by transferring through Chicago, Detroit and Minneapolis. Thus, for these airlines to add this route would likely not increase enplanements significantly because they would be cannibalizing their own existing passenger base.

For these reasons, enplanement levels are not expected to recover to 1999 levels in the next five years. Ultimately, the airport enplanement level may recover but the industry trends for regional airports do not support aggressive recapture of previous enplanement levels. As a result, the FAA TAF forecasts from 2006 appear to be the most reasonable for planning purposes. The TAF shows a modest recapture of enplanements to 252,000 in the next five years. By the long term planning period, the TAF estimates 351,000 enplanements for Lincoln Airport.

Because of year-to-year fluctuations, it is important that the master plan be demand based rather than time based so that the airport authority can better respond to actual needs as they develop in the future. To facilitate this, a series of planning horizons have been established based up on the 20-year forecasting envelope. The selected enplanement forecast most closely resembles the 2006 FAA TAF forecast, except that the figures have been rounded to the nearest thousandth. The enplanement milestones that will be used as master planning horizons for Lincoln Airport are:

- Short Term (0-5 years): 252,000
- Intermediate Term (6-10 years): 281,000
- Long Term (11-20 years): 351,000

AIRLINE FLEET MIX AND OPERATIONS

The type of aircraft in the commercial airline fleet serving the airport is an important component of airport planning. Not only is the commercial airline fleet mix serving the airport helpful in determining the number of commercial airline operations at the airport, but it is also helpful in defining many of the key parameters used in airport planning; namely, the critical aircraft serving the airport (used for pavement design, ramp geometry and terminal complex layout) and the maximum stage length capabilities (which affects runway length evaluations). **Table 2P** presents aircraft information for those aircraft predominantly utilized at Lincoln Airport.

The rebuilding and expansion of the commercial airline fleet continues. Driven by noise standards deadlines, most large air carriers are replacing aging aircraft to meet tougher noise standards. Additionally, airlines are adding new aircraft to expand capacity. For the large air carriers, narrow-body deliveries and orders are outpacing deliveries and orders for wide-body aircraft.

Changes in equipment, airframes, and engines have always had a significant

impact on airlines and airport planning. There are many ongoing programs by the manufacturers to improve performance characteristics. These programs continue to focus on improvements in fuel efficiency and noise reduction. Regional jets have also become a larger factor as the airlines look for ways to reduce costs. Many airlines have replaced larger commercial jets on smaller emerging routes with regional jets.

Regional airlines such as the ones serving Lincoln Airport have transitioned to advanced regional jets to fit

their market needs. As recently as six years ago, United Airlines utilized two Boeing 757s in addition to 737s and 727s for service at Lincoln Airport. The regional jets typically have lower operating costs and allow for greater scheduling flexibility. The regional jets made their initial impact in the 44 to 50-seat range. Regional jet aircraft are now available with as few as 37 seats and as many as 90 seats. This is essentially bridging a long-existing gap in seating capacity. Regional jets have become the aircraft of choice at most regional airports such as Lincoln.

| TABLE 2P | | | | |
|--|---------------------------|-------------------------------|-------------------|----------------------|
| Regional Airline Aircraft Characteristics | | | | |
| Type | Passenger Capacity | Max Cruise Speed (mph) | MTOW(lbs.) | Range (miles) |
| Regional Jets | | | | |
| CRJ-100 | 50 | 593 | 44,000 | 1,620 |
| CRJ-200 | 50 | 593 | 44,000 | 1,685 |
| CRJ-440* | 44 | 593 | 40,000 | 1,685 |
| CRJ-700 | 66 | 593 | 63,500 | 2,250 |
| CRJ-900 | 76-86 | 608 | 70,000 | 1,596 |
| Bae 146/200 | 88 | 475 | 42,200 | 1,290 |
| Bae 146/300 | 100 | 555 | 55,000 | 1,750 |
| ERJ-135 | 37 | 450 | 41,900 | 1,350 |
| ERJ-140 | 44 | 450 | 46,517 | 1,630 |
| ERJ-145 | 50 | 450 | 48,500 | 1,550 |
| Turboprops | | | | |
| Saab 340A | 30 | 324 | 27,275 | 935 |
| Saab 340B | 34 | 324 | 29,000 | 935 |
| * Pinnacle Airlines Exclusive | | | | |
| <i>Source: Aircraft Operating Manuals</i> | | | | |

The commercial service fleet mix is needed to project airline operations for the airport. A projection of the fleet mix for Lincoln Airport has been developed by reviewing aircraft used by the carriers serving the airport. **Table 2Q** depicts the aircraft fleet mix and seating capacities of the airlines serving the airport since 2002.

Table 2Q compares the airline operational fleet mix by seating capacity for the last five years at Lincoln Airport. In 2002, approximately 12 percent of the airport's commercial service flights were by aircraft with 60 seats or more. This was represented by United's use of the Bae-146 series aircraft which are configured for between 88 and 100

passengers. At the completion of the previous master plan in 1998, over 50 percent of the fleet mix was represented by aircraft with 60 seats or more. Today, less than six percent of the commercial service aircraft are configured for more than 60 seats. Of the six percent, less than two percent

is represented by Allegiant Air's use of the MD83 for their service. The remaining 4.3 percent is represented by United Express's use of regional jets configured with 66 seats. The shift to regional jet usage from the time of the previous master plan to today is clear.

TABLE 2Q
Airline Fleet Mix and Operations Forecast
Lincoln Airport

| Fleet Mix by Seating Capacity | ACTUAL | | | | | FORECAST | | |
|-------------------------------|---------|---------|---------|---------|---------|----------|---------|---------|
| | 2002 | 2003 | 2004 | 2005 | 2006* | 2010 | 2015 | 2025 |
| 77+ | 11.57% | 1.60% | 6.31% | 3.87% | 1.89% | 2.0% | 5.0% | 10.0% |
| 60-76 | 0.0% | 0.0% | 0.0% | 1.3% | 4.3% | 6.0% | 10.0% | 15.0% |
| 40-59 | 64.2% | 87.0% | 91.5% | 94.8% | 93.8% | 92.0% | 85.0% | 75.0% |
| 19-39 | 24.2% | 11.4% | 2.2% | 0.0% | 0.0% | 0.0% | 0.0% | 0.0% |
| Total | 100.0% | 100.0% | 100.0% | 100.0% | 100.0% | 100.0% | 100.0% | 100.0% |
| Average Seats Per Departure | 49.2 | 47.1 | 50.8 | 49.8 | 51.8 | 53.2 | 57.0 | 63.0 |
| Board Loading Factor | 67.2% | 70.7% | 70.2% | 66.6% | 71.9% | 70.0% | 70.0% | 70.0% |
| Enplanements Per Departure | 33.1 | 33.3 | 35.6 | 33.2 | 37.2 | 37.2 | 39.9 | 44.1 |
| Annual Enplanements | 230,389 | 211,594 | 221,228 | 202,917 | 192,305 | 252,000 | 281,000 | 351,000 |
| Annual Departures | 6,840 | 6,248 | 6,133 | 6,031 | 5,164 | 6,767 | 7,043 | 7,959 |
| Annual Operations | 13,680 | 12,496 | 12,266 | 12,062 | 10,328 | 13,534 | 14,085 | 15,918 |

* 2006 operations and enplanements estimated based upon January through September data.
Source: Airport Records

The trend in regional jets has been to reconfigure existing jets to accommodate more passengers or to introduce new jets configured for between 76 and 90 passengers. With board loading factors (BLF) hovering around 70 percent, it is reasonable to assume that the larger regional jets will be introduced to the Lincoln market. In addition, to realistically achieve long term enplanement forecast levels of 351,000, an additional carrier would likely need to begin operations at Lincoln Airport. This may be a mainline or low-cost carrier utilizing a larger aircraft such as a 737. The fleet mix forecast reflects this trend by showing the use of aircraft with 77 or more seats, increasing to 10 percent by the long term planning period.

Over 64 percent of the fleet in 2002 was represented by regional jets with between 40 and 59 seats. In 2006, this class of aircraft represents better than 94 percent of the available seats at Lincoln Airport. In the future, this class of aircraft is forecast to lose share percentage to regional jets such as the CRJ-900 with seating capacity of up to 86, or to a new mainline carrier utilizing a 737 or similar aircraft.

The BLF is defined as the ratio of passengers boarding aircraft compared to the seating capacity of the aircraft. The BLF at Lincoln Airport has remained relatively steady in recent years, growing slightly from 67.2 percent in 2002 to 71.9 percent in 2006. The airlines like to see a BLF above 60

percent and generally consider the need for additional flights when the BLF nears 70 percent. The BLF in the future is estimated to level out at 70 percent. This is a high figure and one that the airlines would like to maintain even if flights are added.

The number of passengers on each aircraft has been growing in the previous five years. The average enplanements per departure were 33.1 in 2002. In 2006, the ratio was 37.2 percent. As the average seats per departure increases, so too does the enplanements per aircraft. The forecast shows enplanements per aircraft increasing to 44.1 percent in the long term planning horizon. This forecast increase is reflective of the trend toward utilizing larger regional jets.

Lincoln Airport can expect regional airlines to dominate service into the future. While the 50-passenger aircraft has become the most dominant, new airline orders for regional jets are now focused on 70- and 90-seat aircraft. A growing local market with high BLF figures may also realize some service by the larger commercial jets. The BLF figures may also indicate a need for the existing carriers to add flights.

AIR CARGO

Air cargo is comprised of air freight and air mail. Air freight is handled by both passenger airlines and all-cargo airlines. Air mail is now primarily handled by an all-cargo carrier (FedEx) under contract with the United States Postal Service. Table

1E from the previous chapter showed that mail cargo has been reduced to zero over the past four years, thus future mail cargo is assumed to remain at this level.

Historic air freight activity at Lincoln Airport is presented on **Table 2R**. As can be seen, a change has occurred that has reduced air freight to record low levels. A decreasing trend has been experienced since 1993, but the dramatic drop occurred right around the year 2000. Several factors contributed to this steep decline in air freight activity.

| Year | FREIGHT | |
|-----------------|----------------|----------------|
| | Enplane | Deplane |
| 1993 | 115.40 | 665.86 |
| 1994 | 99.36 | 719.91 |
| 1995 | 75.93 | 282.29 |
| 1996 | 73.35 | 288.89 |
| 1997 | 62.87 | 278.50 |
| 1998 | 60.08 | 233.29 |
| 1999 | 59.30 | 219.70 |
| 2000 | 41.32 | 191.36 |
| 2001 | 26.29 | 109.49 |
| 2002 | 11.10 | 58.89 |
| 2003 | 7.06 | 47.40 |
| 2004 | 12.52 | 29.68 |
| 2005 | 9.09 | 41.11 |
| FORECAST | | |
| 2010 | 1,250 | 1,250 |
| 2015 | 2,100 | 2,100 |
| 2025 | 4,000 | 4,000 |

Source: Airport Records

The most significant factor has been the change in the airline fleet mix. Prior to 2000, both TWA and United were utilizing large commercial service aircraft such as the 727, 737, and

757. These aircraft were fully capable of accommodating both air freight and air mail. With the introduction of regional jets, there is far less space available to accommodate air cargo. As a result, air cargo has dropped dramatically.

In a declining air cargo circumstance, forecasts are difficult to develop with any precision although some assumptions can be made. First, the airline fleet mix forecast for Lincoln Airport does indicate a move toward a larger regional jet. This could accommodate some additional air cargo. The fleet mix projections also consider the introduction of larger aircraft, such as a 737, for some existing routes and the introduction of another significant carrier providing daily service to markets not previously served. These assumptions would allow for some growth in air cargo activity at the airport.

The sharp decline in U.S. mail moving through Lincoln Airport is a direct result of a move by the U.S. Post Office to shift to all-cargo carriers for the mail rather than contract with the airlines. In addition, the limited cargo space available on the regional jets made bulk mail transport inefficient.

In the past, Lincoln Airport has been served by all-cargo carrier Airborne, but this service has since stopped. Currently, there is no dedicated cargo carrier at the airport. Similar to the airlines, all-cargo carriers choose their markets according to proximity to other local population centers and inter-modal transportation availability. For the eastern Nebraska region,

Omaha's Eppley Airfield was chosen by most of the all-cargo carriers including FedEx, UPS, and DHL. For this reason it is unlikely that Lincoln Airport will attract significant all-cargo jet service given the close proximity to Omaha and the availability of Interstate 80.

Some opportunity does exist for Lincoln Airport to attract greater air cargo operations. The Lincoln Air Park and the construction of the new Lincoln Air Park Rail Center may drive demand for air cargo facilities. In addition, the all-cargo carriers typically have a network of "feeder" aircraft which provide cargo transport from more remote location to their hub. A "feeder" could be used to transport cargo to hubs in the future.

The previous master plan considered the addition of an all-cargo carrier to the airport for the same reasons as those presented here. The forecast from the previous master plan remains valid and is presented in **Table 2R**. The type of carrier will be primarily dependent upon the growth of the industrial park and community growth.

GENERAL AVIATION FORECASTS

General aviation encompasses all portions of civil aviation except commercial operations. To determine the types and sizes of facilities that should be planned to accommodate general aviation activity, certain elements of this activity must be forecast. These indicators of general aviation demand

include based aircraft, aircraft fleet mix, and annual operations.

BASED AIRCRAFT

The number of based aircraft is the most basic indicator of general aviation demand. By first developing a forecast of based aircraft, the growth of other general aviation activities and demands can be projected.

Aircraft basing at an airport is somewhat dependent upon the nature and magnitude of aircraft ownership in the local service area. Lincoln Airport serves the general aviation needs of Lancaster County; therefore, the process of developing forecasts of based aircraft begins with a review of historical aircraft registrations in the area.

Aircraft Registrations

Table 2S presents a two-decade history of registered aircraft in Lancaster County. This figure is derived from the FAA aircraft registration databases that categorized registered aircraft by county based on the zip code of the registered aircraft. Although this information generally provides a strong correlation to based aircraft, it is not uncommon for some aircraft to be registered in the county, but based at an airport outside the county.

Since 1986, aircraft registrations in Lancaster County have increased by 10 percent or 23 aircraft. The previous six years has actually realized a decrease in the number of registra-

tions, from a high of 272 in 2001, down to the current level of 255. A series of projections were developed to evaluate the potential growth of aircraft demand in the region over the next 20 years.

Time-series analyses and regressions were run to examine growth trends over the past two decades; however; none produced a correlation coefficient (r^2) above 0.90, which would have indicated a reasonable statistical fit. Therefore, these projections were not considered further.

Next, a market share analysis was performed to examine Lancaster County aircraft registrations as a percentage of active general aviation aircraft in the United States. The county market share of U.S. active aircraft has fluctuated between a high of 0.139 in 1994, and a low of 0.116 percent in 2004. A projection was developed based upon maintaining the current market share ratio (0.118%) into the future. FAA forecasts of active aircraft were used to develop this projection and resulted in 276 registered aircraft in 2010, 293 in 2015, and 320 in 2025.

Finally, registered aircraft were examined as a ratio of Lancaster County population. The ratio of aircraft to residents has declined slightly in recent years from a high of 1.09 in 1999, to 0.95 aircraft per 1,000 residents in 2005. Maintaining the 2005 ratio constant through the planning period, yields 365 based aircraft by 2025.

These projections are relatively similar through 2015, but vary in the long-

term. The selected projection follows a mid-range projection most closely related to the constant market share projection. Using this forecast, aircraft registrations in the county are

forecast to grow by 23 percent over the next twenty years. The selected forecast of registered aircraft in Lancaster County results in 275 in 2010, 295 in 2015, and 330 in 2025.

TABLE 2S
Registered Aircraft Projections
Lancaster County

| Year | County Registrations | U.S. Active Aircraft | Market Share | County Population | Aircraft per 1,000 Pop. |
|---|-----------------------------|-----------------------------|---------------------|--------------------------|--------------------------------|
| 1986 | 232 | NA | NA | NA | NA |
| 1987 | 229 | NA | NA | NA | NA |
| 1988 | 220 | NA | NA | NA | NA |
| 1989 | 215 | NA | NA | NA | NA |
| 1990 | 211 | NA | NA | 213,641 | 0.99 |
| 1991 | 214 | NA | NA | 216,566 | 0.99 |
| 1992 | 206 | NA | NA | 219,805 | 0.94 |
| 1993 | 220 | 177,719 | 0.124% | 223,512 | 0.98 |
| 1994 | 240 | 172,936 | 0.139% | 225,885 | 1.06 |
| 1995 | 241 | 188,089 | 0.128% | 229,063 | 1.05 |
| 1996 | 242 | 191,129 | 0.127% | 231,190 | 1.05 |
| 1997 | 246 | 192,414 | 0.128% | 233,788 | 1.05 |
| 1998 | 243 | 204,710 | 0.119% | 235,537 | 1.03 |
| 1999 | 258 | 219,464 | 0.118% | 237,657 | 1.09 |
| 2000 | 270 | 217,533 | 0.124% | 251,152 | 1.08 |
| 2001 | 272 | 211,447 | 0.129% | 253,183 | 1.07 |
| 2002 | 269 | 211,244 | 0.127% | 256,374 | 1.05 |
| 2003 | 259 | 209,606 | 0.123% | 260,047 | 1.00 |
| 2004 | 246 | 212,390 | 0.116% | 261,742 | 0.94 |
| 2005 | 252 | 214,591 | 0.117% | 264,814 | 0.95 |
| 2006 | 255 | 216,835 | 0.118% | NA | NA |
| Constant Market Share Projection | | | | | |
| 2010 | 276 | 234,030 | 0.118% | 295,423 | 0.93 |
| 2015 | 293 | 248,120 | 0.118% | 322,057 | 0.91 |
| 2025 | 320 | 271,600 | 0.118% | 383,844 | 0.83 |
| Aircraft per 1,000 Population Projection | | | | | |
| 2010 | 281 | 234,030 | 0.118% | 295,423 | 0.95 |
| 2015 | 306 | 248,120 | 0.123% | 322,057 | 0.95 |
| 2025 | 365 | 271,600 | 0.134% | 383,844 | 0.95 |
| Selected Projection | | | | | |
| 2010 | 275 | 234,030 | 0.118% | 295,423 | 0.93 |
| 2015 | 295 | 248,120 | 0.119% | 322,057 | 0.92 |
| 2025 | 330 | 271,600 | 0.122% | 383,844 | 0.86 |

Based Aircraft Forecast

Determining the number of based aircraft at an airport can be a challenging task because the number of based aircraft can change frequently. Only recently has the FAA formally re-

quested that all airports maintain annual based aircraft figures. Fortunately, Lincoln Airport has consistently maintained historic based aircraft figures as part of their annual Part 139 certification (commercial service).

Utilizing the forecast of Lancaster County registered aircraft, a based aircraft forecast can now be determined. As presented on **Table 2T**, based aircraft have increased from 145 in 1990, to 190 in 2006. A high point of 198 based aircraft was reached in 2001. Since 1990, the airport has

based, on average, 68 percent of the county aircraft registrations. Each of the previous six years, except one, has seen the airport capture in excess of 70 percent of the county registered aircraft. The previous six-year average was 73.1 percent.

| TABLE 2T Based Aircraft Forecasts Lincoln Airport | | | |
|---|-------------------------------|---|--|
| Year | Lincoln Based Aircraft | Lancaster County Registered Aircraft | Lincoln Airport Share of County Registered Aircraft |
| 1990 | 145 | 211 | 68.7% |
| 1991 | 147 | 214 | 68.7% |
| 1992 | 147 | 206 | 71.4% |
| 1993 | 147 | 220 | 66.8% |
| 1994 | 151 | 240 | 62.9% |
| 1995 | 149 | 241 | 61.8% |
| 1996 | 148 | 242 | 61.2% |
| 1997 | 148 | 246 | 60.2% |
| 1998 | 146 | 243 | 60.9% |
| 1999 | 177 | 258 | 68.6% |
| 2000 | 177 | 270 | 65.6% |
| 2001 | 198 | 272 | 72.8% |
| 2002 | 193 | 269 | 71.7% |
| 2003 | 177 | 259 | 68.3% |
| 2004 | 195 | 246 | 79.3% |
| 2005 | 181 | 252 | 71.8% |
| 2006 | 190 | 255 | 74.5% |
| CONSTANT SHARE OF REGISTERED AIRCRAFT | | | |
| 2010 | 201 | 275 | 73.1% |
| 2015 | 216 | 295 | 73.1% |
| 2025 | 241 | 330 | 73.1% |
| INCREASING SHARE FORECAST | | | |
| 2010 | 204 | 275 | 74.0% |
| 2015 | 224 | 295 | 76.0% |
| 2025 | 264 | 330 | 80.0% |
| SELECTED FORECAST | | | |
| 2010 | 200 | 275 | 72.7% |
| 2015 | 215 | 295 | 72.9% |
| 2025 | 240 | 330 | 72.7% |
| <i>Source: Historical based aircraft - Airport records; Historical registered aircraft - FAA Census of U.S. Civil Aircraft 2006</i> | | | |

Two forecasts have been developed based on the airport capturing based

aircraft from the pool of registered aircraft in Lancaster County. The first

forecast considers the airport maintaining a constant 73.1 percent share of county registered aircraft. This results in 201 based aircraft in 2010, 216 based aircraft in 2015, and 241 based aircraft in 2025. Over the 20-year planning period, this forecast adds 51 new based aircraft.

The second forecast considers the airport attracting an increasing market share of based aircraft from the pool of Lancaster County registered aircraft. This forecast results in a long term based aircraft figure of 264 aircraft, an addition of 74 aircraft.

Prior to making a final based aircraft forecast, it is prudent to analyze how these figures compare to previously completed forecasts. The FAA TAF provides a based aircraft forecast that considers 226 aircraft for every year through the planning period. The based aircraft forecast for Lincoln Airport does not exceed the FAA TAF until 2020. The previous master plan considered a year 2020 based aircraft total of 185. This figure has already been exceeded.

The selected forecast, presented on **Exhibit 2G**, is slightly below the con-

stant share forecast primarily because the airport has been losing based aircraft as a share of the overall U.S. general aviation fleet. As with the enplanement forecasts, the yearly forecast for based aircraft will be converted to planning horizons in order to facilitate a more fluid demand-based master plan. The following based aircraft forecast will be utilized to determine airport needs over the planning scope of this master plan:

- Short Term: 200
- Intermediate Term: 215
- Long term: 240

Based Aircraft Fleet Mix

The based aircraft fleet mix at Lincoln Airport, as presented in **Table 2U**, was compared to the existing and forecast U.S. general aviation fleet mix trends as presented in *FAA Aerospace Forecasts Fiscal Years 2006-2017*. The FAA expects business jets will continue to be the fastest growing general aviation aircraft type in the future. The number of business jets in the industry fleet is expected to nearly double in the next twelve years.

| Aircraft Type | EXISTING | | FORECAST | | | | | |
|---------------|------------|----------------|------------|----------------|-------------------|----------------|------------|----------------|
| | Based | Percent | Short Term | Percent | Intermediate Term | Percent | Long Term | Percent |
| Single Engine | 124 | 68.51% | 137 | 68.50% | 148 | 68.84% | 167 | 69.58% |
| Multi-Engine | 39 | 21.55% | 42 | 21.00% | 43 | 20.00% | 44 | 18.33% |
| Jet | 14 | 7.73% | 17 | 8.50% | 19 | 8.84% | 23 | 9.58% |
| Helicopter | 4 | 2.21% | 4 | 2.00% | 5 | 2.33% | 6 | 2.50% |
| Totals | 181 | 100.00% | 200 | 100.00% | 215 | 100.00% | 240 | 100.00% |

Source: Airport Records; Coffman Associates Analysis

Single-engine piston aircraft (including sport aviation and experimental aircraft), helicopter, and turboprop aircraft are expected to grow at slower rates. The number of multi-engine piston aircraft in the U.S. will experience only minimal increases as older aircraft are retired according to the FAA forecasts.

The forecast based aircraft mix considers an increasing trend for based business jets increasing from 15 currently to 23 by the long term planning period. Single engine aircraft will continue to dominate the based aircraft fleet mix and growth is in line with FAA forecasts. As a percent of the fleet mix at the airport, multi-engine aircraft are decreasing.

GENERAL AVIATION OPERATIONS

General aviation (GA) operations are classified by the airport traffic control tower (ATCT) as either local or itinerant. A local operation is a take-off or landing performed by an aircraft that operates within sight of the airport, or which executes simulated approaches or touch-and-go operations at the airport. Itinerant operations are those performed by aircraft with a specific origin or destination away from the airport. Generally, local operations are characterized by training operations. Typically, itinerant operations increase with business and commercial use, since business aircraft are operated on a higher frequency.

Itinerant Operations

Table 2V depicts general aviation itinerant operations from 1998 through 2005. General aviation itinerant operations have followed a path similar to overall operations, in that operations increased in the 1990s, reaching a high of 47,953 in 2000. Since 2000, general aviation itinerant operations have trended down to a low of 31,097 in 2005. This trend is reflective of the national trends as forecast by the FAA. In the immediate future the FAA forecasts national itinerant operations to grow by 1.019 percent annually.

Two forecasts for itinerant operations at Lincoln Airport were developed by comparing to national itinerant operations as forecast by the FAA. The first considers itinerant operations as a constant share of national itinerant operations. This forecast results in a long term total of 45,592 itinerant operations. This figure actually is less than the total realized at the airport in 2000.

A second forecast has been developed. This forecast presents an increasing market share of national itinerant operations. This forecast results in 59,373 itinerant operations by the long term planning period. A number of factors would lead to this forecast being considered including the improved national economic outlook and the lack of an aviation-related terrorist attack since 9/11. In addition, general aviation aircraft deliveries are in-

BASED AIRCRAFT

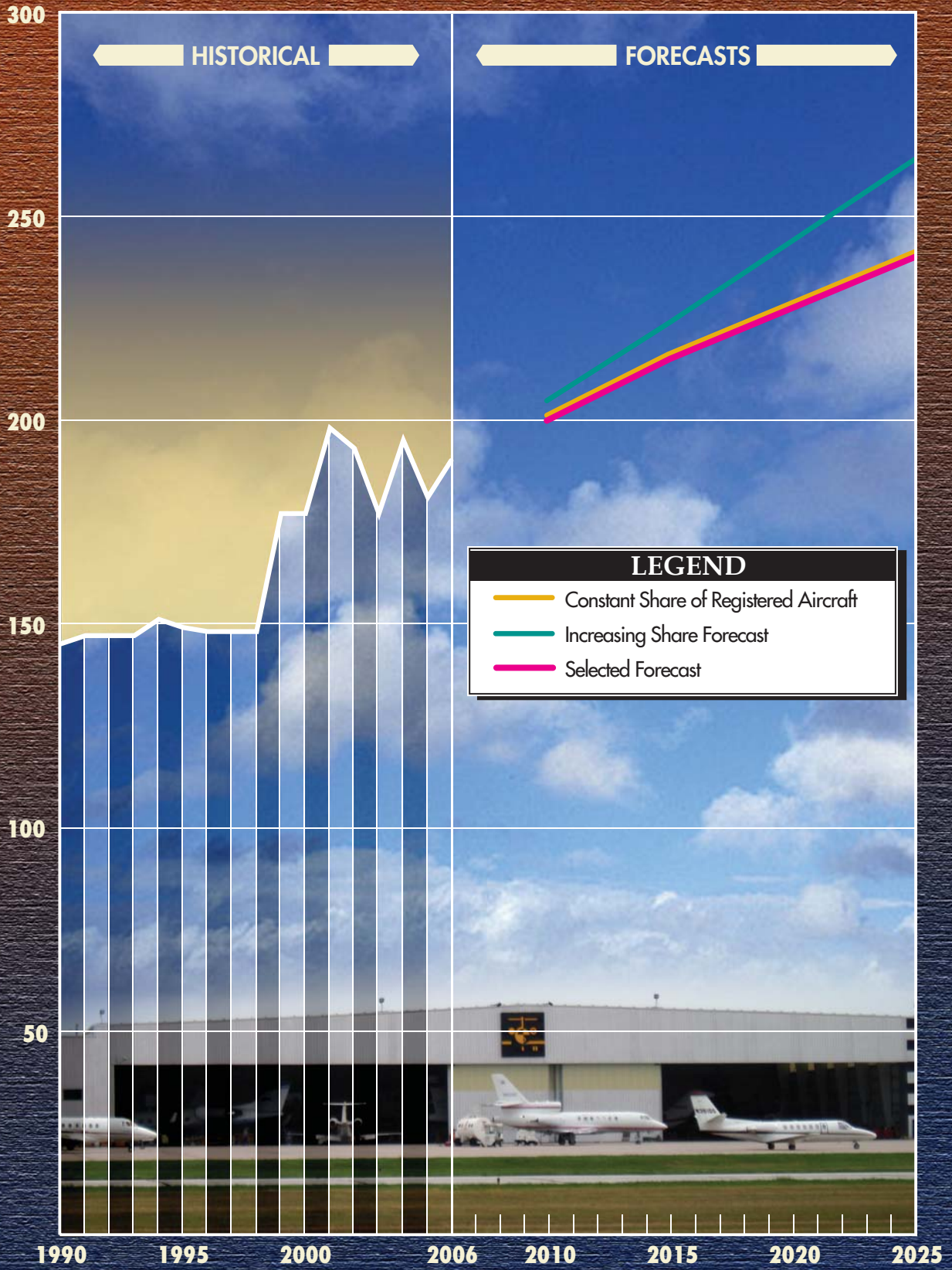

creasing and Lincoln Airport is home to a nationally recognized aviation

maintenance company in Duncan Aviation.

TABLE 2V
General Aviation Itinerant Operations Forecast
Lincoln Airport

| Year | GA Itinerant Operations | U.S. GA Itinerant Operations | Market Share Itinerant Operations | Based Aircraft | Itinerant Operations Per Based Aircraft |
|---|--------------------------------|-------------------------------------|--|-----------------------|--|
| 1998 | 36,572 | 22,086,500 | 0.1656% | 148 | 247 |
| 1999 | 43,788 | 23,019,400 | 0.1902% | 177 | 247 |
| 2000 | 47,953 | 22,844,100 | 0.2099% | 177 | 271 |
| 2001 | 43,160 | 21,433,300 | 0.2014% | 198 | 218 |
| 2002 | 41,679 | 21,450,500 | 0.1943% | 193 | 216 |
| 2003 | 36,146 | 20,231,300 | 0.1787% | 177 | 204 |
| 2004 | 32,965 | 20,007,200 | 0.1648% | 195 | 169 |
| 2005 | 31,097 | 19,284,100 | 0.1613% | 181 | 172 |
| Constant Market Share of Total U.S. Itinerant Operations | | | | | |
| 2010 | 33,662 | 20,874,800 | 0.1613% | 200 | 168 |
| 2015 | 37,770 | 23,422,400 | 0.1613% | 215 | 176 |
| 2025 | 45,592 | 28,273,087 | 0.1613% | 240 | 190 |
| Increasing Market Share of Total U.S. Itinerant Operations | | | | | |
| 2010 | 36,113 | 20,874,800 | 0.1730% | 200 | 181 |
| 2015 | 43,566 | 23,422,400 | 0.1860% | 215 | 203 |
| 2025 | 59,373 | 28,273,087 | 0.2100% | 240 | 247 |
| Selected Forecast | | | | | |
| 2010 | 36,000 | 20,874,800 | 0.1725% | 200 | 180 |
| 2015 | 44,000 | 23,422,400 | 0.1879% | 215 | 205 |
| 2025 | 59,000 | 28,273,087 | 0.2087% | 240 | 246 |

Source: FAA Aerospace Forecasts 2006-2017; 2003-2005 Tower Records; 1998-2002 Part 139 Operations submissions.

The increasing share forecast has been selected, with the figures rounded to the nearest thousand for use as a planning forecast. The selected forecast for 2010 is 36,000 itinerant operations, which is within 4.3 percent of the FAA TAF forecast of 34,449. The selected forecast for 2015 is 44,000 itinerant operations, which is within 15 percent of the FAA TAF. The long range selected forecast is 59,000 operations, which is somewhat higher than the 2025 FAA TAF forecast of 41,938.

The table also examines the relationship of annual itinerant operations to based aircraft. This ratio has fluctuated between 170 and 270 annual operations per based aircraft since 1998. The selected forecast results in the operations per based aircraft increasing from 180 in 2010, to 246 by 2025. These figures are well within the range of reasonableness for the airport.

Local Operations

A similar methodology was utilized to forecast local operations. **Table 2W** depicts the history of local operations at Lincoln Airport, and examines its historic market share of general aviation (GA) local operations at towered airports in the United States. Local operations began to decline from

38,988 operations in 2000, to 8,481 in 2005. This is a significant drop in local operations that indicates that some dramatic events have effected local operations. A portion of the decline can certainly be attributed to the effects of 9/11 and the subsequent economic recession. Most of the decline is likely attributable to the largest flight school at the airport closing in 2003.

| TABLE 2W | | | | | |
|---|----------------------------|---------------------------------|--------------------------------------|-----------------------|--|
| General Aviation Local Operations Forecast | | | | | |
| Lincoln Airport | | | | | |
| Year | GA Local Operations | U.S. GA Local Operations | Market Share Local Operations | Based Aircraft | Local Operations Per Based Aircraft |
| 1998 | 28,887 | 15,960,000 | 0.1810% | 148 | 195 |
| 1999 | 35,019 | 16,980,200 | 0.2062% | 177 | 198 |
| 2000 | 38,988 | 17,034,400 | 0.2289% | 177 | 220 |
| 2001 | 31,617 | 16,193,700 | 0.1952% | 198 | 160 |
| 2002 | 24,034 | 16,172,800 | 0.1486% | 193 | 125 |
| 2003 | 14,619 | 15,292,100 | 0.0956% | 177 | 83 |
| 2004 | 10,538 | 14,960,400 | 0.0704% | 195 | 54 |
| 2005 | 8,481 | 14,817,800 | 0.0572% | 181 | 47 |
| Constant Market Share of U.S. General Aviation Local Operations | | | | | |
| 2010 | 23,841 | 16,119,900 | 0.1479% | 200 | 119 |
| 2015 | 26,220 | 17,727,900 | 0.1479% | 215 | 122 |
| 2025 | 31,340 | 21,190,200 | 0.1479% | 240 | 131 |
| Increasing Market Share of U.S. General Aviation Local Operations | | | | | |
| 2010 | 12,896 | 16,119,900 | 0.0800% | 200 | 64 |
| 2015 | 22,160 | 17,727,900 | 0.1250% | 215 | 103 |
| 2025 | 46,618 | 21,190,200 | 0.2200% | 240 | 194 |
| Selected Forecast | | | | | |
| 2010 | 13,000 | 16,119,900 | 0.0806% | 200 | 65 |
| 2015 | 22,000 | 17,727,900 | 0.1241% | 215 | 102 |
| 2025 | 46,000 | 21,190,200 | 0.2171% | 240 | 192 |
| <i>Source: FAA Aerospace Forecasts 2006-2017; 2003-2005 Tower Records; 1998-2002 Part 139 Operations submissions.</i> | | | | | |

Two local general aviation forecasts have been developed. The first considers local operations remaining constant in relation to national local general aviation operations at towered airports in the U.S. The constant percentage utilized is an average of the

previous eight years which includes both the high point in 2000 and the low point in 2005. This forecast results in 23,841 local operations in 2010, 26,220 local operations in 2015, and 31,340 local operations in 2025.

The second forecast considers an increasing market share of total U.S. local operations. This forecast considers the possibility of a new flight school coming to the airport or an existing FBO ramping up training operations. The increasing share forecast increases moderately to nearly recapture the market share of U.S. local operations Lincoln had in 2000.

The selected forecast is the increasing market share forecast rounded to the nearest thousandth. The FAA TAF forecast estimates local general aviation operations at Lincoln Airport for every year from 2005 to 2025 at 8,453. The selected forecast considers the return of at least one flight school. Thus, the 2010 forecast of local operations is 13,000. The 2015 forecast is 22,000 annual operations, and the 2025 forecast is for 46,000 operations. **Exhibit 2H** presents both local and itinerant general aviation operations forecasts for Lincoln Airport.

A final comparison of local operations per based aircraft was considered as a check on the validity of the selected forecast. In 2005, there were on average 47 local general operations per based aircraft. The selected forecast considered 65 operations per based aircraft. A high of 220 operations per

based aircraft was realized in the year 2000. The high for the long term in the selected forecast is 192 local general aviation operations per based aircraft. Thus, the selected forecast appears to be well within the reasonable range.

OTHER AIR TAXI

Air taxi operations as reported by the ATCT include commuter passenger, commuter cargo, as well as for-hire general aviation operations. Some operations by aircraft operated under fractional ownership programs are also counted as air taxi operations. Since the airline and cargo operations have been forecast, this section reviews the growth potential for the "other air taxi" operations.

Table 2X presents the other air taxi operations for the past three years. These operations have averaged .3975 percent of all U.S. itinerant air taxi operations at towered airports. Because of the relationship to national air taxi activity, other air taxi operations were projected to increase in line with that of U.S. itinerant operations air taxi operations. The resulting forecast is also presented on **Table 2X**.

| TABLE 2X | | | |
|----------------------------------|-----------------------|---|----------------|
| Other Air Taxi Operations | | | |
| Lincoln Airport | | | |
| Year | Other Air Taxi | U.S. Itinerant Air Taxi Operations | Percent |
| 2003 | 6,190 | 11,426,000 | 0.0542% |
| 2004 | 7,017 | 12,243,900 | 0.0573% |
| 2005 | 5,629 | 12,571,900 | 0.0448% |
| FORECAST | | | |
| 2010 | 7,190 | 13,804,900 | 0.0521% |
| 2015 | 8,231 | 15,802,600 | 0.0521% |
| 2025 | 10,505 | 20,169,356 | 0.0521% |

Source: Lincoln ATCT records

MILITARY ACTIVITY

Lincoln Airport is utilized by the Nebraska Air National Guard's (NEANG) 155th Air Refueling Wing, as well as the Nebraska Army National Guard (NEARNG). The 155th Air Refueling Wing operates nine KC-135 refueling aircraft. The NEANG has approximately 300 men and women stationed at Lincoln Airport on the weekdays and approximately 930 one weekend per month. The NEANG facilities are located to the south of the terminal area. The NEARNG currently does not have aircraft stationed at Lincoln Airport, and its facilities are located south of the NEANG facilities.

Lincoln Airport has been an attractive airport for military operations because of the availability of a long runway with a diversity of approaches including the instrument landing system (ILS). Currently, the airport is serving as a temporary base for many of the aircraft from Offutt Air Force Base, which is undergoing runway re-

surfacing projects. This accommodation will end in October 2006.

Table 2Y presents the annual military operations since 1998 at Lincoln Airport. During that period, operations have averaged 22,158 annually. Future activity is dependent upon the future missions at the base and in the region. This makes projecting military utilization difficult since local missions can change with little notice. For example, the NEARNG had 31 aircraft based at the airport including Blackhawk and Cobra helicopters, until 2001, when this equipment was relocated away from the airport. This move is reflected in the decrease in overall local military operations after 2000.

For planning purposes, military operations were forecast to remain constant at around 22,500 annual operations in the future. This includes 15,000 itinerant and 7,500 local operations. This is similar to the FAA TAF forecast of 14,948 itinerant and 4,733 local military operations annually.

| Year | Itinerant | Local | Total |
|-----------------|------------------|--------------|--------------|
| 1998 | 13,107 | 13,293 | 26,400 |
| 1999 | 12,416 | 11,948 | 24,364 |
| 2000 | 10,999 | 10,037 | 21,036 |
| 2001 | 12,674 | 7,194 | 19,868 |
| 2002 | 14,644 | 6,441 | 21,085 |
| 2003 | 15,749 | 6,174 | 21,923 |
| 2004 | 17,549 | 6,217 | 23,766 |
| 2005 | 13,331 | 5,494 | 18,825 |
| FORECAST | | | |
| 2010 | 15,000 | 7,500 | 22,500 |
| 2015 | 15,000 | 7,500 | 22,500 |
| 2025 | 15,000 | 7,500 | 22,500 |

Source: ATCT 2003-2005; FAA TAF 1998-2002

General Aviation Local Operations Forecast

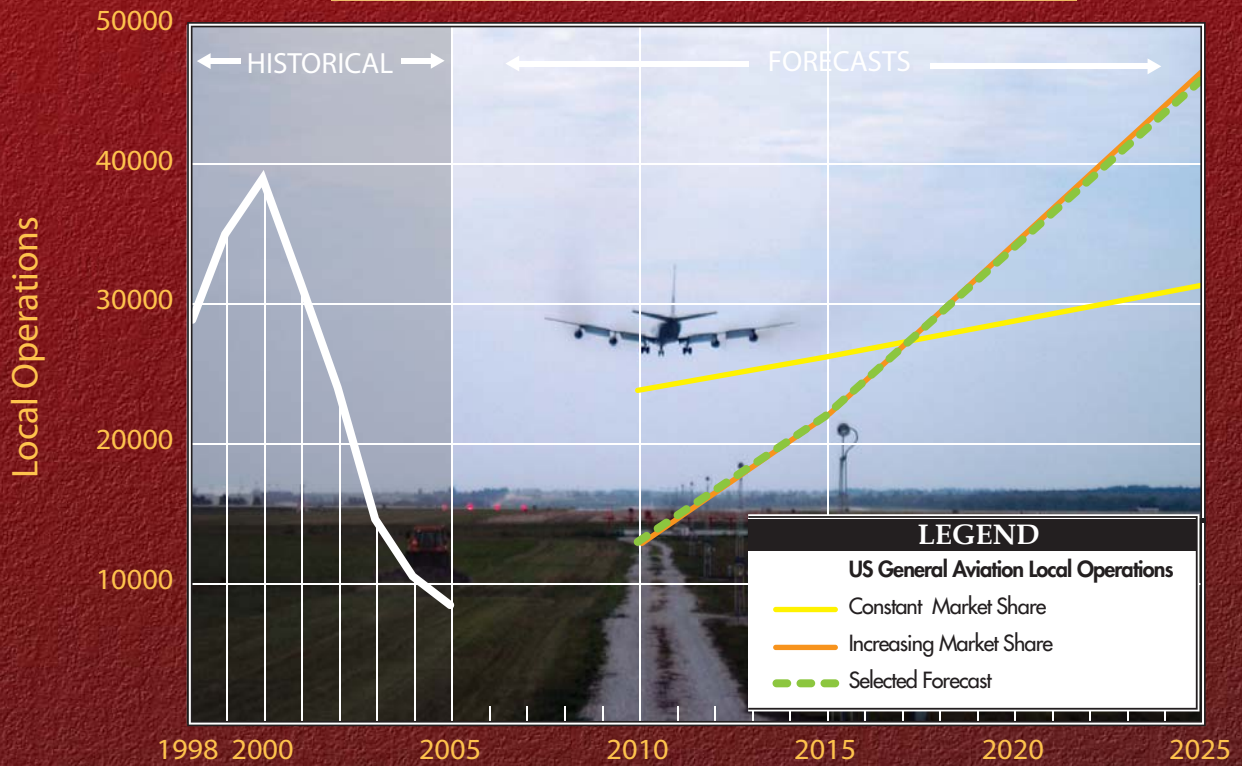

General Aviation Itinerant Operations Forecast

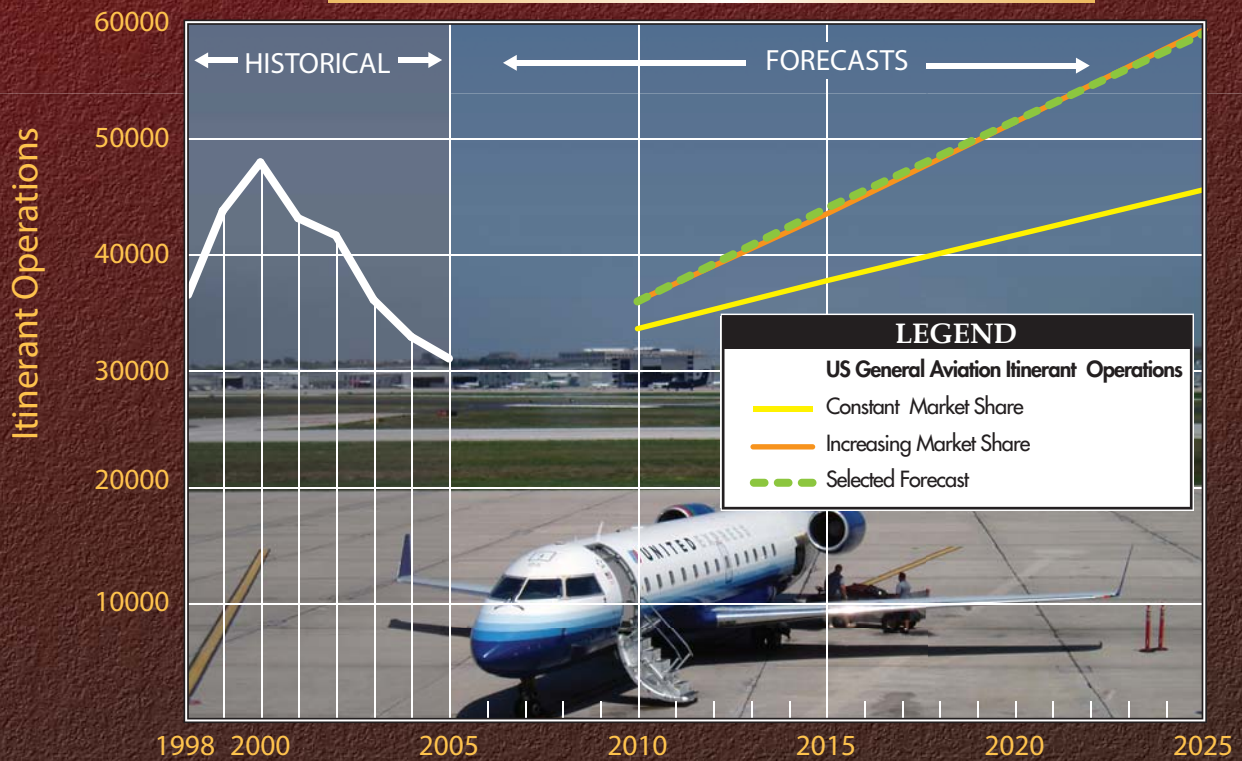

ANNUAL INSTRUMENT APPROACHES

Forecasts of annual instrument approaches provide guidance in determining an airport's requirements for navigational aid facilities. An instrument approach is defined by FAA as "an approach to an airport with intent to land by an aircraft in accordance with an Instrument Flight Rule (IFR) flight plan, when visibility is less than three miles and/or when the ceiling is at or below the minimum initial approach altitude."

Data on instrument approaches to Lincoln Airport was obtained from FAA statistics for the past eight years (1998-2005). For commercial opera-

tions, AIAs have averaged 3.3 percent of annual air carrier and air taxi operations. The AIA percentage for military activity has averaged 1.88 percent of itinerant military operations. For planning purposes, an average of 2.00 percent is used for future military AIAs. The AIAs for general aviation have averaged 1.72 percent of itinerant operations. The percentages can be expected to remain relatively constant through the planning period, with the exception of general aviation, where a growing mix of more-sophisticated business aircraft and more widespread use of GPS (Global Positioning System) will increase the percentage over time. **Table 2Z** presents the AIA forecast for Lincoln Airport.

TABLE 2Z

**Annual Instrument Approaches
Lincoln Airport**

| Year | Air Carrier/Air Taxi | General Aviation | Military | Total |
|-----------------|-----------------------------|-------------------------|-----------------|--------------|
| 1998 | 1,611 | 1,757 | 689 | 4,057 |
| 1999 | 783 | 941 | 269 | 1,993 |
| 2000 | 430 | 688 | 117 | 1,235 |
| 2001 | 298 | 385 | 134 | 817 |
| 2002 | 492 | 505 | 238 | 1,235 |
| 2003 | 622 | 577 | 315 | 1,514 |
| 2004 | 250 | 273 | 160 | 683 |
| 2005 | 226 | 266 | 131 | 623 |
| FORECAST | | | | |
| 2010 | 662 | 620 | 300 | 1,605 |
| 2015 | 728 | 880 | 300 | 1,918 |
| 2025 | 878 | 1,475 | 300 | 2,659 |

Source: FAA APO Approach Operations

SUMMARY

This chapter has outlined the various activity levels that might reasonably be anticipated over the planning period. **Exhibit 2J** provides a summary of the aviation forecasts prepared in

this chapter. Actual activity is included for 2005, which serves as the base year for these forecasts.

Lincoln Airport has realized a significant shift in the fleet mix of the airlines serving the airport. All carriers

have transitioned to regional jet service which is less expensive to operate and more efficient for the airlines. At the same time, overall passenger enplanements have been experiencing a downward trend over the course of the last six years. Lincoln has been significantly affected by the availability of low-cost carrier service from Omaha's Eppley Airfield. Low-cost carriers, such as Southwest Airlines at Eppley Airfield, tend to draw from a larger geographic area than mainline carriers. Thus, many passengers that might otherwise fly from Lincoln are willing to drive to Omaha primarily to take advantage of lower fares.

Airline passenger activity has potential for growth primarily because it has been historically profitable for an airline to operate from the airport. On average, more than 70 percent of the available seats are sold. This board loading factor (BLF) is very high and typically presents an opportunity for existing carriers to add flights or for a new carrier to begin operations.

Cargo shipment at Lincoln Airport has been severely affected by the U.S. Postal Service transitioning the transport of the mail to all-cargo carriers. Mail as a percentage of all air cargo has been reduced to zero and is not expected to change. Some opportunity exists for an all-cargo carrier cargo operator to locate at the airport particu-

larly if the Lincoln Air Park Rail Center grows substantially.

Based aircraft at Lincoln are expected to see some growth over the planning period. Business and corporate aircraft will spur most general aviation growth. The growth in smaller piston aircraft will depend upon the availability of services and facilities in the future.

Military activity will also continue to be a factor at Lincoln because of the Nebraska Air National Guard and Army National Guard units based at the airport. In addition, aircraft based at nearby Offutt Air Force Base regularly practice at the airport. In fact, Lincoln is attractive to military training operations from all over the region.

The next step in the planning process is to assess the capabilities of the existing facilities to determine what upgrades may be necessary to meet future demands. The forecasts developed here will be taken forward in the next chapter as planning horizon activity levels that will serve as milestones or activity benchmarks in evaluating facility requirements. Peak activity characteristics will also be determined for the various activity levels, for use in determining facility needs.

| | ACTUAL | FORECASTS | | |
|-------------------------------------|----------------|----------------|----------------|----------------|
| | 2005 | 2010 | 2015 | 2025 |
| ANNUAL OPERATIONS | | | | |
| General Aviation | | | | |
| Itinerant | 31,097 | 36,000 | 44,000 | 59,000 |
| Local | 8,481 | 13,000 | 22,000 | 46,000 |
| Military | | | | |
| Itinerant | 13,331 | 15,000 | 15,000 | 15,000 |
| Local | 5,494 | 7,500 | 7,500 | 7,500 |
| Air Taxi | 5,629 | 7,190 | 8,231 | 10,505 |
| Air Carrier | 12,645 | 13,534 | 14,085 | 15,918 |
| Total Local | 13,975 | 20,500 | 29,500 | 53,500 |
| Total Itinerant | 50,057 | 71,724 | 81,316 | 100,423 |
| TOTAL OPERATIONS | 76,677 | 92,224 | 110,816 | 153,923 |
| AIRLINE ENPLANEMENTS | 202,917 | 252,000 | 281,000 | 351,000 |
| AIR CARGO (TONS) | 50 | 2,500 | 4,200 | 8,000 |
| BASED AIRCRAFT | | | | |
| Single Engine | 124 | 137 | 148 | 167 |
| Multi-engine | 39 | 42 | 43 | 44 |
| Business Jet | 14 | 17 | 19 | 23 |
| Helicopter | 4 | 4 | 5 | 6 |
| TOTAL BASED AIRCRAFT | 181 | 200 | 215 | 240 |
| INSTRUMENT APPROACHES (AIAS) | 623 | 1,605 | 1,918 | 2,659 |

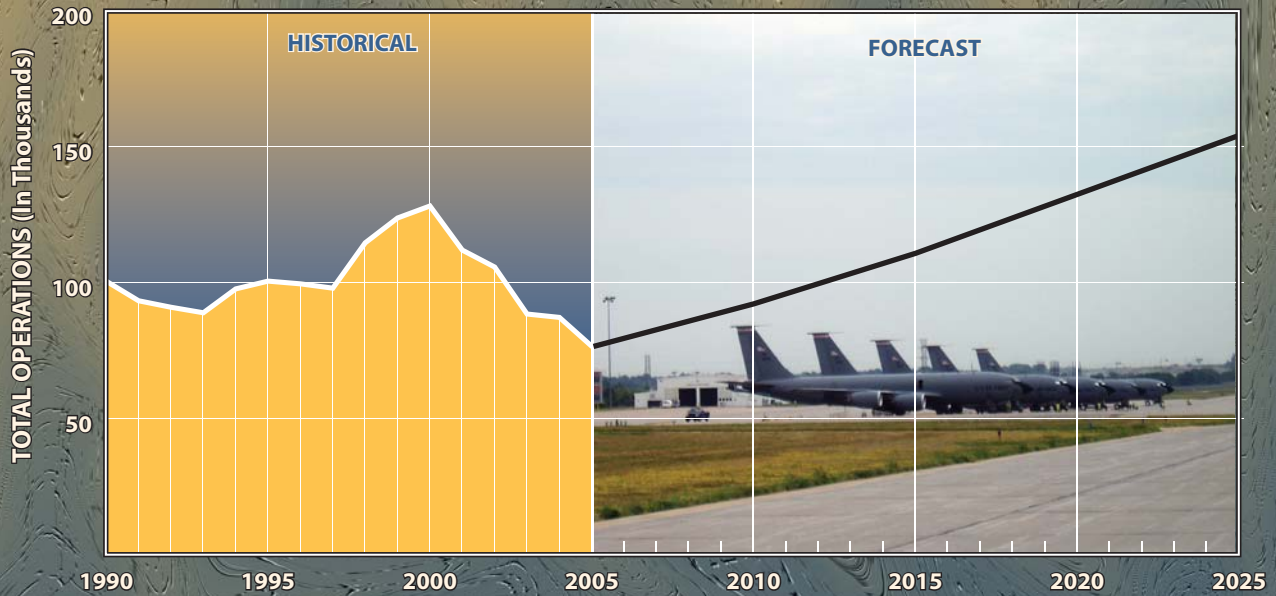

FACILITY REQUIREMENTS

Lincoln Airport

FACILITY REQUIREMENTS

To properly plan for the future at Lincoln Airport (LNK), it is necessary to translate forecast aviation demand into the specific types and quantities of facilities that can adequately serve projected demand levels. This chapter uses the results of the forecasts conducted in Chapter Two, as well as established planning criteria, to determine the airfield (i.e., runways, taxiways, navigational aids, marking and lighting, and support facilities), and landside (i.e., terminal building, cargo buildings, hangars, aircraft parking apron, fueling, vehicle parking and access) facility requirements.

The objective of this effort is to identify, in general terms, the adequacy of the existing airport facilities, outline what new facilities

may be needed, and when they may be needed to accommodate forecast demands. Having established these facility requirements, alternatives for providing the facilities will be evaluated in Chapter Four to determine the most cost-effective and efficient means for implementation.

PLANNING HORIZONS

Cost-effective, safe, efficient, and orderly development of an airport should rely more upon actual demand than a time-based forecast figure. Thus, in order to develop a master plan that is demand-based rather than time-based, a series of planning horizon milestones have been established, as discussed in Chapter Two - Forecasts, that take into consideration the reasonable range of aviation demand projections.



It is important to consider that, over time, the actual activity at the airport may be higher or lower than what the annualized forecast portrays. By planning according to activity milestones, the resultant plan can accommodate unexpected shifts, or changes in the area's aviation demand. It is important to plan for these milestones so that airport officials can respond to unexpected changes in a timely fashion. As a result, these milestones provide flexibility, while potentially extending this plan's useful life if aviation trends slow over the period.

The most important reason for utilizing milestones is to allow the airport to develop facilities according to need generated by actual demand levels. The demand-based schedule provides flexibility in development, as the schedule can be slowed or expedited according to actual demand at any given time over the planning period. The resultant plan provides airport officials with a financially responsible and need-based program. **Table 3A** presents the planning horizon milestones for each activity demand category.

| TABLE 3A Planning Horizon Activity Levels Lincoln Airport | | | | |
|--|------------------|--------------------------|-------------|-------------|
| | BASE YEAR | PLANNING HORIZONS | | |
| | 2005 | 2010 | 2015 | 2025 |
| Air Carrier Activity | | | | |
| Enplaned Passengers | 202,917 | 252,000 | 281,000 | 351,000 |
| Annual Operations | 12,645 | 13,534 | 14,085 | 15,918 |
| General Aviation Activity | | | | |
| Based Aircraft | 181 | 200 | 215 | 240 |
| Annual Operations | | | | |
| Itinerant | 31,097 | 36,000 | 44,000 | 59,000 |
| Local | 8,481 | 13,000 | 22,000 | 46,000 |
| <i>Total General Aviation Operations</i> | 39,578 | 49,000 | 66,000 | 105,000 |
| Other Air Taxi Activity | 5,629 | 7,190 | 8,231 | 10,505 |
| Military Activity | | | | |
| Itinerant | 13,331 | 15,000 | 15,000 | 15,000 |
| Local | 5,494 | 7,500 | 7,500 | 7,500 |
| <i>Total Military Operations</i> | 18,825 | 22,500 | 22,500 | 22,500 |
| Total Airport Operations | 76,677 | 92,224 | 110,816 | 153,923 |
| Annual Instrument Approaches | 623 | 1,605 | 1,918 | 2,659 |

In this chapter, existing components of the airport are evaluated so that the capacities of the overall system are identified. Once identified, the existing capacity is compared to the planning horizon milestones to determine where deficiencies currently exist or

may be expected to materialize in the future. Once deficiencies in a component are identified, a more specific determination of the approximate sizing and timing of the new facilities can be made.

PEAKING CHARACTERISTICS

Airport capacity and facility need analyses typically consider the levels of activity during a peak or design period. The periods used in developing the capacity analyses and facility requirements in this study are as follows:

- **Peak Month** - The calendar month in which traffic activity is highest.
- **Design Day** - The average day in the peak month. This indicator is easily derived by dividing the peak month operations by the number of days in the month.
- **Busy Day** - The busy day of a typical week in the peak month. This descriptor is used primarily to determine general aviation transient ramp parking requirements.
- **Design Hour** - The busiest hour within the design day or busy day.

It is important to note that only the peak month is an absolute peak within a given year. All other peak periods will be exceeded at various times during the year. However, they do represent reasonable planning standards that can be applied without overbuilding or being too restrictive.

AIRLINE PEAK PERIODS

Monthly passenger activity at LNK was reviewed over the last several years. The peak passenger demand is

typically in June, coinciding with the summer vacation season. Since 1998, the peak month totals have fluctuated around an average of 9.5 percent of the annual enplaned passengers.

Airline operations have varied less from month-to-month. Peaks in a given year are often created by changes in flight schedules. The peak month has averaged 9.2 percent of the annual airline operations.

The design day of the peak month is essentially the average weekday of the peak month. To account for slightly fewer flights on weekends, the design day for operations is obtained by dividing by a factor of 29.5 rather than 30 or 31.

Hourly passenger activity is examined as a percentage of the daily activity. This can be greatly affected by the number of flights and the aircraft seats available during the design hour. According to the July 2006 flight schedule, LNK had 30 daily arrivals and departures, spread throughout the day. This includes the Wednesday and Saturday departures for Allegiant Air. The hourly peak for departures was four beginning at 12:47 p.m.; the hourly peak for arrivals was also four and it begins at 12:15 p.m. The peak hour for total operations (arrivals and departures) is eight beginning at 12:15 p.m.

Based upon a review of the aircraft mix during the peak hour, there were a total of 300 seats available during the peak hour for departures. This represented 35.0 percent of the daily seats available. The design hour pas-

sengers were determined using an 85 percent boarding load factor during the peak hour.

A similar methodology was used for deplanements and total passengers. There were 294 arrival seats during the peak hour or 35 percent of the daily seats available. There are 594

total seats (35 percent) during the total passenger peak. As traffic increases, it can be anticipated that additional flights may be added throughout the day, decreasing the design hour percentage slightly. This is reflected in the airline peaking characteristics summarized in **Table 3B**.

| TABLE 3B Airline Peak Activity Lincoln Airport | | | | |
|---|----------------|-------------------|--------------------------|------------------|
| | Current | Short Term | Intermediate Term | Long Term |
| Airline Enplanements | | | | |
| Annual | 202,917 | 252,000 | 281,000 | 351,000 |
| Peak Month | 19,742 | 24,948 | 27,819 | 34,749 |
| Design Day | 681 | 860 | 959 | 1,198 |
| Design Hour | 255 | 301 | 326 | 359 |
| Deplanements | | | | |
| Design Hour | 255 | 301 | 326 | 359 |
| Total Passengers | | | | |
| Design Day | 1,362 | 1,721 | 1,919 | 2,396 |
| Design Hour | 509 | 602 | 652 | 719 |
| Airline Operations | | | | |
| Annual | 12,062 | 13,534 | 14,085 | 15,918 |
| Peak Month | 1,108 | 1,243 | 1,294 | 1,462 |
| Design Day | 38 | 42 | 44 | 50 |
| Design Hour | 8 | 9 | 10 | 11 |
| Departures | | | | |
| Design Day | 19 | 21 | 22 | 25 |
| Design Hour | 4 | 5 | 5 | 6 |
| Arrivals | | | | |
| Design Day | 19 | 21 | 22 | 25 |
| Design Hour | 4 | 5 | 5 | 6 |

ITINERANT GENERAL AVIATION/AIR TAXI PEAKS

The peak month for general aviation and air taxi itinerant operations at LNK is typically in August. Over the last several years the peak month averaged 11.7 percent of the annual general aviation/air taxi itinerant operations. Daily operational counts from the ATCT were utilized to determine a

busy day peaking factor for itinerant general aviation activity. The design day was determined as the peak month divided by 30, or the number of days in the month. The design hour for itinerant operations was determined from an average of the ATCT hourly counts on the top ten peak days for the previous year. The design hour averages 17.5 percent of the design day operations. **Table 3C** summa-

izes the peak activity projections for each planning horizon for general

aviation and air taxi itinerant operations.

| TABLE 3C General Aviation/Air Taxi Itinerant Operational Peak Lincoln Airport | | | | |
|--|--------|--------|--------|---------|
| Annual | 45,207 | 56,239 | 74,287 | 115,860 |
| Peak Month | 5,311 | 6,607 | 8,727 | 13,611 |
| Design Day | 177 | 220 | 291 | 454 |
| Design Hour | 31 | 39 | 51 | 79 |

TOTAL OPERATIONS PEAK PERIODS

The peaking characteristics of total aircraft operations, which include general aviation local operations and military operations, are utilized in examining the operational capacity of the airfield. The peak month for total operations has averaged 9.9 percent over the last several years. The peak

month is typically during the summer months.

Design hour operations were determined from ATCT hourly data to average 13 percent of the daily operations. This can be expected to decline slightly as activity increases. **Table 3D** also summarizes the peak activity projections for the total operations planning horizons.

| TABLE 3D Peak Total Operations Lincoln Airport | | | | |
|---|----------------|-------------------|--------------------------|------------------|
| | Current | Short Term | Intermediate Term | Long Term |
| Annual | 76,677 | 92,273 | 110,872 | 154,278 |
| Peak Month | 8,481 | 9,227 | 10,533 | 13,885 |
| Design Day | 283 | 308 | 351 | 463 |
| Design Hour | 37 | 40 | 46 | 60 |

AIRFIELD CAPACITY

Airfield capacity is measured in a variety of different ways. The **hourly capacity** measures the maximum number of aircraft operations that can take place in an hour. The **annual service volume (ASV)** is an annual level of service that may be used to define airfield capacity needs. **Aircraft delay** is the total delay incurred by

aircraft using the airfield during a given timeframe. FAA Advisory Circular 150/5060-5, *Airport Capacity and Delay*, provides a methodology for examining the operational capacity of an airfield for planning purposes. This analysis takes into account specific factors about the airfield. These various factors are depicted in **Exhibit 3A**. The following describes the input factors as they relate to Lincoln Airport:

- **Runway Configuration** – The existing runway configuration consists of a primary runway, Runway 18-36, with an intersecting crosswind runway, Runway 14-32. An additional parallel runway, Runway 17-35, is available approximately 3,000 feet to the east of the primary runway. This parallel runway is primarily utilized by general aviation and air taxi operators.
- **Runway Use** – Runway use is normally dictated by wind conditions. The direction of takeoffs and landings are generally determined by the speed and direction of the wind. It is gener-

ally safest for aircraft to takeoff and land into the wind, avoiding a crosswind (wind that is blowing perpendicular to the travel of the aircraft) or tailwind components during these operations. Prevailing winds are from the south during the summer months and from the north during the winter months. The availability of instrument approaches is also considered. All runways, except Runway 32, have straight-in instrument approaches. For planning purposes, the runway use percentages presented in **Table 3E** are considered for Lincoln Airport.

| Runway Configuration | Weather Condition | Time in Use |
|-----------------------------|--------------------------|--------------------|
| 18-36 & 14-32 | VFR | 5.0% |
| 18-36 & 17-35 | VFR | 89.2% |
| 18-36 & 14-32 | IFR | 1.0% |
| 18-36 & 17-35 | IFR | 4.2% |
| 18-36 | PVC | 0.6% |

VFR - > 3 miles visibility and > 1,000 foot cloud ceilings
 IFR - visibility > 1 mile < 3 miles and/or clouds >500 feet < 1,000 feet
 PVC - visibility < one statute mile and/or clouds < 500 feet
Source: LNK All Weather Observations 1996-2005; FAA AC 150/5060-5, Airport Capacity and Delay

- **Exit Taxiways** - Based upon mix, taxiways located between 5,000 and 7,000 feet from the landing threshold count in the exit rating for each runway. There are currently two exits available within this range for each runway. Therefore, the exit rating is two for all runways.

- **Weather Conditions** – The airport operates under visual meteorological conditions (VMC) 93.6 percent of the time. Instrument meteorological conditions (IMC) occur when cloud ceilings are between 500 and 1,000 feet and visibility is between one and three statute miles. This occurs 5.8 percent

AIRFIELD LAYOUT

RUNWAY CONFIGURATION



RUNWAY USE



NUMBER OF EXITS



WEATHER CONDITIONS

VMC



IMC



PVC



AIRCRAFT MIX

A & B

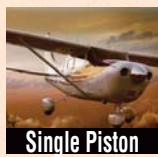

Single Piston



Small Turboprop



Twin Piston

C



Business Jet

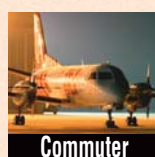

Commuter

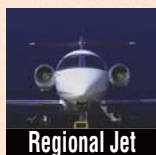

Regional Jet



Commerical Jet



Wide Body Jet

D

OPERATIONS

ARRIVALS AND DEPARTURES



TOTAL ANNUAL OPERATIONS

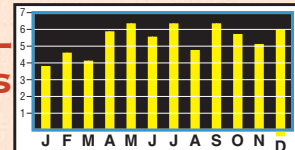

TOUCH-AND-GO OPERATIONS



of the time. Poor visibility conditions (PVC) apply for minimums below 500 feet and one mile. This occurs approximately 0.6 percent of the time.

- **Aircraft Mix** - Descriptions of the classifications and the percentage mix for each planning horizon are presented in **Table 3F**.

TABLE 3F
Total Operations By Classification, By Weather Condition
Lincoln Airport

| | Weather Condition | Existing | Percent | Short Term | Percent | Inter. Term | Percent | Long Term | Percent |
|----------------|--------------------------|-----------------|----------------|-------------------|----------------|--------------------|----------------|------------------|----------------|
| A&B | | 33,659 | 43.9% | 40,697 | 44.1% | 53,137 | 47.9% | 79,662 | 51.6% |
| | VFR | 31,505 | 93.6% | 38,092 | 93.6% | 49,737 | 93.6% | 74,564 | 93.6% |
| | IFR | 1,952 | 5.8% | 2,360 | 5.8% | 3,082 | 5.8% | 4,620 | 5.8% |
| | PVC | 202 | 0.6% | 244 | 0.6% | 319 | 0.6% | 478 | 0.6% |
| Totals | | 33,659 | 100.0% | 40,697 | 100.0% | 53,137 | 100.0% | 79,662 | 100.0% |
| C | | 26,076 | 34.0% | 31,326 | 33.9% | 37,485 | 33.8% | 54,366 | 35.2% |
| | VFR | 24,407 | 93.6% | 29,321 | 93.6% | 35,086 | 93.6% | 50,887 | 93.6% |
| | IFR | 1,512 | 5.8% | 1,817 | 5.8% | 2,174 | 5.8% | 3,153 | 5.8% |
| | PVC | 156 | 0.6% | 188 | 0.6% | 225 | 0.6% | 326 | 0.6% |
| Totals | | 26,076 | 100.0% | 31,326 | 100.0% | 37,485 | 100.0% | 54,366 | 100.0% |
| D | | 16,943 | 22.1% | 20,250 | 21.9% | 20,250 | 18.3% | 20,250 | 13.1% |
| | VFR | 15,858 | 93.6% | 18,954 | 93.6% | 18,954 | 93.6% | 18,954 | 93.6% |
| | IFR | 983 | 5.8% | 1,175 | 5.8% | 1,175 | 5.8% | 1,175 | 5.8% |
| | PVC | 102 | 0.6% | 122 | 0.6% | 122 | 0.6% | 122 | 0.6% |
| Totals | | 16,943 | 100.0% | 20,250 | 100.0% | 20,250 | 100.0% | 20,250 | 100.0% |
| TOTALS | | 76,677 | | 92,273 | | 110,872 | | 154,278 | |

Definitions:

- Class A: Small single-engine aircraft with gross weight of 12,500 pounds or less.
- Class B: Small twin-engine aircraft with gross weight of 12,500 pounds or less.
- Class C: Large aircraft with gross weights over 12,500 pounds up to 300,000 pounds.
- Class D: Large aircraft with gross weights over 300,000 pounds.

- **Percent Arrivals** - Generally follows the typical 50-50 percent split.
- **Touch-and-Go Activity** - Touch and go activity has dropped steadily since 2000. Touch and go activity by general aviation aircraft accounts for approximately 11 percent of operations. Military touch and go activity accounts for an additional seven percent of activity.
- **Peak Period Operations** - For the airfield capacity analysis, average daily operations and average peak hour operations during the peak month area, as calculated in the previous section, are utilized. Typical operations activity is important in the calculation of an airports annual service volume as “peak demand” levels occur sporadically. The peak periods used in the capacity analysis

are representative of normal operational activity and can be exceeded at various times throughout the year.

CALCULATION OF ANNUAL SERVICE VOLUME

The preceding information was used in conjunction with the airfield capacity methodology developed by the FAA to determine airfield capacity for Lincoln Airport.

Hourly Runway Capacity

The first step in determining annual service volume involves the computation of the hourly capacity of each runway configuration. The percentage use of each runway, the amount of touch-and-go training activity, and the number and location of runway exits become important factors in determin-

ing the hourly capacity of each runway configuration.

As presented in **Table 3F**, the mix of aircraft operating at an airport remains relatively steady with operations by C and D aircraft progressively representing a slightly lower overall percent of operation. This progression would be representative as smaller aircraft operations increase at a greater rate than that of commercial and military flight. This shift in aircraft mix results in hourly capacities increasing over time, and as a direct result, the overall airport capacity increasing over time as well.

Annual Service Volume

Once the hourly capacity is known, the annual service volume can be determined. Annual service volume is calculated by the following equation:

| | |
|--|---|
| $\text{Annual Service Volume} = C \times D \times H$ | |
| C = | weighted hourly capacity |
| D = | ratio of annual demand to average daily demand during the peak month |
| H = | ratio of average daily demand to average peak hour demand during the peak month |

Following this formula, the current annual service volume for Lincoln Airport has been estimated at 172,000 operations. In the short term, ASV increases to 190,000 and by the long term, the ASV reaches 218,000 annual operations.

The master plan conducted in 1992 is the most recent capacity analysis

available for comparison. In that master plan, the ASV was calculated to be approximately 260,000 by 2010. The primary difference between the two calculations is that aircraft in the D category represented only six percent of total operations. In these calculations, D aircraft, primarily represented by the KC-135 refueling tankers based at the airport, represent 20

percent of the current operations. The larger D aircraft require greater separation distances and more time on the runway, thus, the overall capacity is reduced.

Delay

As the number of annual aircraft operations approaches the airfield's capacity, increasing amounts of delay to aircraft operations begin to occur. Delays occur to arriving and departing aircraft in all weather conditions. Arriving aircraft delays result in aircraft holding outside of the airport traffic area. Departing aircraft delays result in aircraft holding at the runway end until released by the air traffic control tower.

Currently, total annual delay at the airport is estimated at 192 hours. It should be noted that delays of five to ten times the average could be experi-

enced by individual aircraft during peak periods. If no capacity improvements are made, annual delay can be expected to reach 1,080 hours by the long range planning horizon. This calculates to an average delay of 25 seconds per aircraft. The FAA threshold for significant delay is four minutes, thus Lincoln Airport appears to provide enough capacity through the planning period.

Conclusion

Table 3G summarizes annual service volume values. **Exhibit 3B** compares annual service volume to existing and forecast operational levels. The 2005 total of 76,677 operations represented 44.6 percent of the existing annual service volume. By the end of the long term planning period, total annual operations are expected to represent 70.8 percent of annual service volume.

| TABLE 3G Airfield Demand/Capacity Summary Lincoln Airport | | | | |
|--|-------------------------|-------------------|--------------------------|------------------|
| | PLANNING HORIZON | | | |
| | Current | Short Term | Intermediate Term | Long Term |
| Operational Demand | | | | |
| Annual Design Hour | 76,677 | 92,273 | 110,872 | 154,278 |
| | 37 | 40 | 46 | 60 |
| Capacity | | | | |
| Annual Service Volume | 172,000 | 192,000 | 203,000 | 218,000 |
| Percent Capacity | 44.58% | 48.06% | 54.62% | 70.77% |
| Weighted Hourly Capacity | 83 | 83 | 84 | 85 |
| Delay | | | | |
| Per Operation (Minutes) | 0.15 | 0.17 | 0.24 | 0.42 |
| Total Annual (Hours) | 192 | 226 | 443 | 1,080 |

FAA Order 5090.3B, *Field Formulation of the National Plan of Integrated*

Airport Systems (NPIAS), indicates that improvements for airfield capac-

ity purposes should begin to be considered once operations reach 60 to 75 percent of the annual service volume. This is an approximate level to begin the detailed planning of capacity improvements. Actual implementation may be deferred until such time that the improvement is considered timely and cost-beneficial. The airfield capacity analysis indicated that the airfield will reach 60 percent of its annual service volume (ASV) by 128,000 annual operations, which is within the long term planning horizon.

Although capacity constraints are not an issue at the airport currently, capacity forecasts indicate that some relatively minor improvements may benefit the airport by the long term. Improvements such as high-speed taxiways exits in strategic locations can add as much as 10 percent to overall capacity. These options will be considered further in Chapter Four.

CRITICAL AIRCRAFT

The selection of appropriate FAA design standards for the development and location of airport facilities is based primarily upon the characteristics of the aircraft which are currently using, or are expected to use the airport. The critical design aircraft is defined as the most demanding category of aircraft, or family of aircraft, which conducts at least 500 operations per year at the airport. Planning for future aircraft use is of particular importance since design standards are used to plan separation distances between facilities. These future stan-

dards must be considered now to ensure that short term development does not preclude the long range potential needs of the airport.

The FAA has established a coding system to relate airport design criteria to the operational and physical characteristics of aircraft expected to use the airport. This airport reference code (ARC) has two components: the first component, depicted by a letter, is the aircraft approach category and relates to aircraft approach speed (operational characteristic); the second component, depicted by a Roman numeral, is the airplane design group and relates to aircraft wingspan or tail height (physical characteristic), whichever is more demanding. Generally, aircraft approach speed applies to runways and runway-related facilities, while airplane wingspan or tail height primarily relates to separation criteria involving taxiways, taxilanes, and landside facilities.

According to FAA Advisory Circular (AC) 150/5300-13, *Airport Design*, an aircraft's approach category is based upon 1.3 times its stall speed in landing configuration at that aircraft's maximum certificated weight. The five approach categories used in airport planning are as follows:

Category A: Speed less than 91 knots.

Category B: Speed 91 knots or more, but less than 121 knots.

Category C: Speed 121 knots or more, but less than 141 knots.

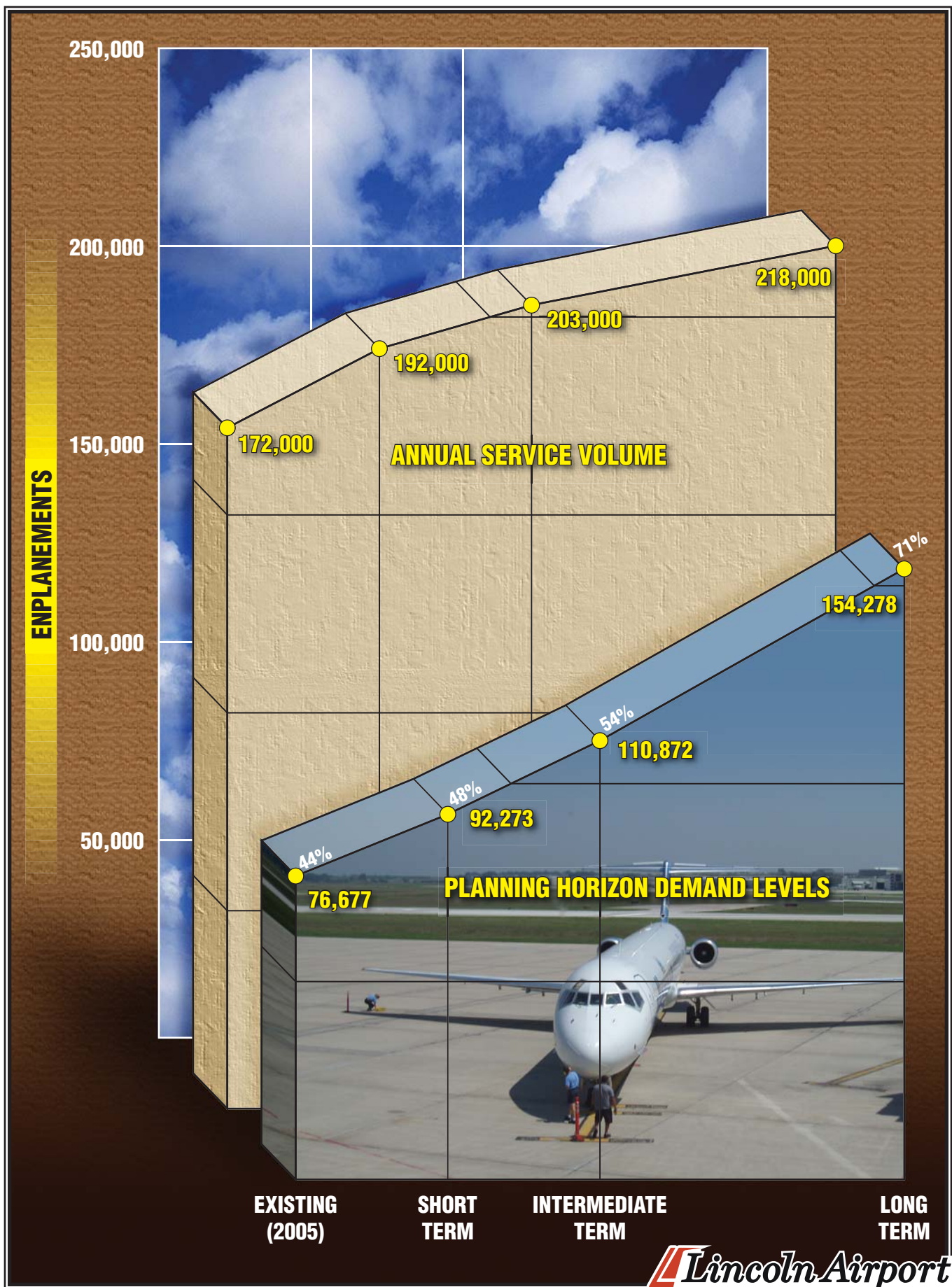

Category D: Speed 141 knots or more, but less than 166 knots.

Category E: Speed greater than 166 knots.

The airplane design group (ADG) is based upon either the aircraft's wingspan or tail height, whichever is greater. For example, an aircraft may fall in ADG III for wingspan at 95 feet, but ADG IV for tail height at 46 feet. This aircraft would be classified under ADG IV. The six ADGs used in airport planning are as follows:

| ADG | Tail Height (ft) | Wingspan (ft) |
|-----|------------------|---------------|
| I | <20 | <49 |
| II | 20-<30 | 49-<79 |
| III | 30-<45 | 70-<118 |
| IV | 45-<60 | 118-<171 |
| V | 60-<66 | 171-<214 |
| VI | 66-<80 | 214-<262 |

Source: 150/5300-13, Change 10

Exhibit 3C summarizes representative aircraft by ARC.

In order to determine several airfield design requirements, the critical aircraft and critical ARC should first be determined. Appropriate airport design criteria can then be applied. This begins with a review of the type of aircraft using and expected to use Lincoln Airport.

At commercial airports such as LNK, the critical aircraft typically come from the passenger or cargo airline fleets. With no regular cargo operations currently, the commercial fleet serving the airport must be considered. Currently, the largest civil aircraft regularly operating at the airport

is the MD-83, as utilized by Allegiant Air. This aircraft currently provides direct service to Las Vegas on Wednesdays and Saturdays. The MD-83 has a wingspan of 108 feet and a tail height of 29.5 feet and falls in approach category D, thus the associated ARC would be D-III.

In the recent past, both American and United Airlines have operated Boeing 757s at the airport. Consideration should be given to the potential return of scheduled commercial service utilizing the full range of commercial aircraft including those ranging up to Group IV, such as the B-757. **The Airport Reference Code utilized for planning at Lincoln Airport falls in ARC D-IV.**

The Lincoln Airport Authority airfield operates under a Joint Use Agreement with the Air and Army National Guard, so consideration of the military requirements must also be addressed in the ARC determination. The Nebraska Air National Guard 155th Air Refueling Wing utilizes Boeing KC-135 refueling aircraft. The KC-135, a military variant of the Boeing 707, is categorized as an ARC C-IV aircraft (wingspan of 145 feet and 8 inches; tail height of 41 feet 8 inches). Without a significant change in the role of the Nebraska Air National Guard, it is anticipated that the fleet of KC-135s will remain based at the airport through the planning period.

In addition to the based military aircraft, Lincoln Airport also serves a regional military role. During the past several months, runways at Offutt Air Force Base, 40 miles to the northeast,

have undergone reconstruction. The military temporarily relocated many aircraft to the west ramp at Lincoln Airport. This includes two E-4 aircraft, which are converted 747s which fall in ARC D-V.

The airport should also consider the full range of business jets operating at the airport. This is particularly true since there is a large aircraft maintenance operation at the airport that attracts customers internationally. Runway 17-35 is primarily utilized by the general aviation aircraft and should be designed to accommodate the full range of business jets.

The most demanding business jets will be the Gulfstream models IV and V, as well as the Boeing Business Jet (BBJ). These aircraft fall within approach categories C and D and airplane design groups II and III. **Therefore, the long range design group for general aviation aircraft for Lincoln Airport is recommended to be ARC D-III.**

AIRFIELD REQUIREMENTS

The analyses of the operational capacity and the critical design aircraft are used to determine airfield needs. This includes runway configuration, dimensional standards, pavement strength, as well as navigational aids, lighting, and marking.

RUNWAY CONFIGURATION

Key considerations in the runway configuration of an airport involve the orientation for wind coverage and the

operational capacity of the runway system. FAA Advisory Circular 150/5300-13, Change 10, *Airport Design*, recommends that a crosswind runway should be made available when the primary runway orientation provides less than 95 percent wind coverage for any aircraft forecast to use the airport on a regular basis.

The 95 percent wind coverage is computed on the basis of the crosswind component not exceeding 10.5 knots (12 mph) for ARC A-I and B-I; 13 knots (15 mph) for ARC A-II and B-II; and 16 knots (18 mph) for ARC A-III, B-III, and C-I through D-II; and 20 knots (23 mph) for ARC C-III through D-IV.

The previous 10 years of wind data was obtained from the National Climatic Data Center and has been analyzed to identify wind coverage provided by the existing runway orientations. At Lincoln Airport, the orientation of Runways 18-36 and 17-35 provide 92.7 percent coverage for 10.5 knot crosswinds, and 96.32 percent coverage for 13 knot crosswinds. Runway 14-32 provides less than 95 percent coverage for these two crosswind components. Thus, neither of the single runway orientations available at LNK provides adequate wind coverage for up to ARC B-I aircraft.

The combined wind coverage provided by the parallel runways and the crosswind runway, however, exceeds 95 percent for all the design speeds. Thus, the three runways at Lincoln Airport provide adequate wind coverage. Both the IFR and VFR wind roses are presented on **Exhibit 3D**.

A-I



- Beech Baron 55
- Beech Bonanza
- Cessna 150
- Cessna 172
- Cessna Citation Mustang
- **Eclipse 500**
- Piper Archer
- Piper Seneca

C-I, D-I



- Beech 400
- **Lear** 25, 31, **35**, 45, 55, 60
- Israeli Westwind
- HS 125-400, 700

B-I *less than 12,500 lbs.*



- Beech Baron 58
- Beech King Air 100
- Cessna 402
- **Cessna 421**
- Piper Navajo
- Piper Cheyenne
- Swearingen Metroliner
- Cessna Citation I

C-II, D-II



- Cessna Citation III, VI, VIII, X
- **Gulfstream II, III, IV**
- Canadair 600
- ERJ-135, 140, 145
- CRJ-200, 700, 900
- Embraer Regional Jet
- Lockheed JetStar
- Super King Air 350

B-II *less than 12,500 lbs.*



- **Super King Air 200**
- Cessna 441
- DHC Twin Otter

C-III, D-III



- ERJ-170, 190
- Boeing Business Jet
- B 727-200
- **B 737-300 Series**
- MD-80, DC-9
- Fokker 70, 100
- A319, A320
- Gulfstream V
- Global Express

B-I, B-II *over 12,500 lbs.*



- Super King Air 300
- Beech 1900
- Jetstream 31
- Falcon 10, 20, 50
- Falcon 200, 900
- **Citation II, III, IV, V**
- Saab 340
- Embraer 120

C-IV, D-IV



- **B-757**
- B-767
- C-130
- DC-8-70
- DC-10
- MD-11
- L1011

A-III, B-III



- DHC Dash 7
- **DHC Dash 8**
- DC-3
- Convair 580
- Fairchild F-27
- ATR 72
- ATP

D-V



- **B-747 Series**
- B-777

Note: Aircraft pictured is identified in bold type.

Draft: 06MP13-30-11/13/06

| ALL WEATHER WIND COVERAGE | | | | |
|---------------------------|------------|----------|----------|----------|
| Runway | 10.5 Knots | 13 Knots | 16 Knots | 20 Knots |
| Runway 14-32 | 89.75% | 94.87% | 98.36% | 99.60% |
| Runway 17-35 | 92.70% | 96.32% | 98.86% | 99.69% |
| Runway 18-36 | 92.70% | 96.32% | 98.86% | 99.69% |
| Combind | 97.31% | 98.91% | 99.73% | 99.93% |

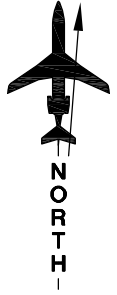

| IFR CAT-I WIND COVERAGE | | | | |
|-------------------------|------------|----------|----------|----------|
| Runway | 10.5 Knots | 13 Knots | 16 Knots | 20 Knots |
| Runway 14-32 | 89.55% | 94.75% | 98.34% | 96.60% |
| Runway 17-35 | 92.61% | 96.28% | 98.85% | 99.68% |
| Runway 18-36 | 92.61% | 96.28% | 98.85% | 99.68% |
| Combind | 97.25% | 98.89% | 99.72% | 99.30% |

Magnetic Variance
 04° 21' East (November 2006)
 Annual Rate of Change
 00° 07' West (November 2006)

SOURCE:
 NOAA National Climatic Center
 Asheville, North Carolina
 Lincoln Airport (LNK)
 Lincoln, Nebraska

OBSERVATIONS:
 76,656 All Weather Observations
 84,945 IFR CAT-I Observations
 1996-2005

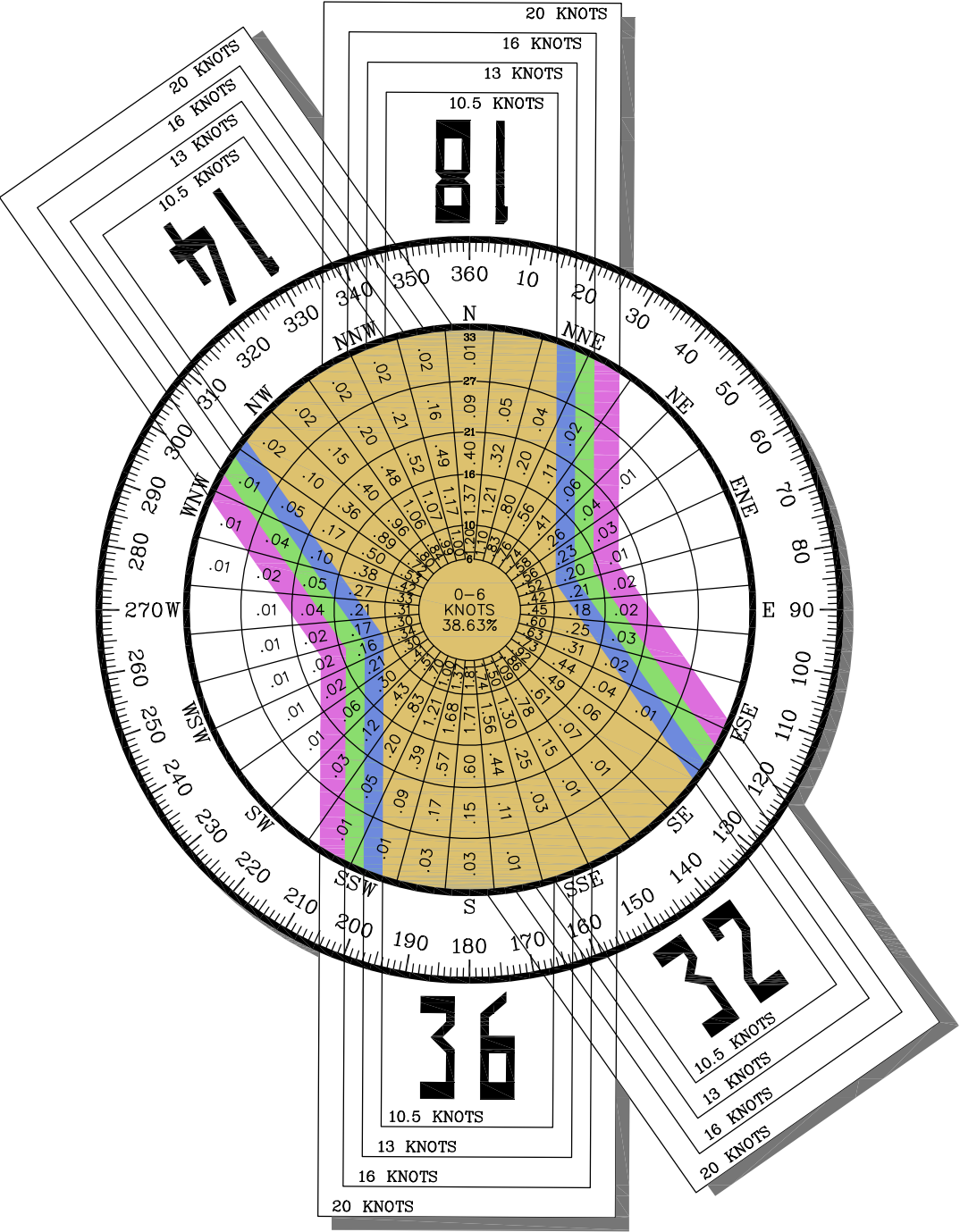
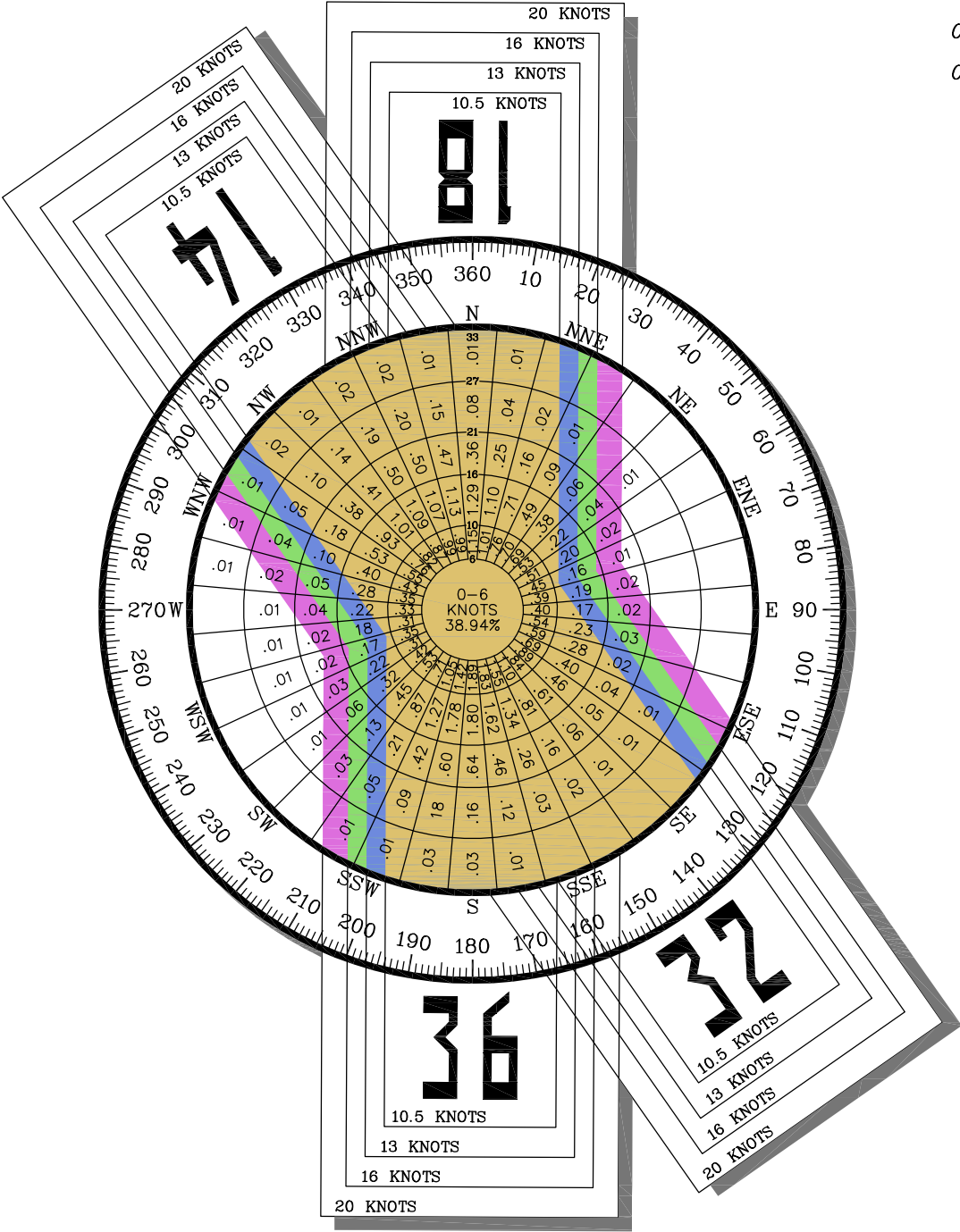

RUNWAY DIMENSIONAL REQUIREMENTS

Runway dimensional standards include the length and width of the runway, as well as the dimensions associated with runway safety areas and other clearances. These requirements are based upon the design aircraft, or group of aircraft. The runway length must consider the performance characteristics of individual aircraft types, while the other dimensional standards are generally based upon the most critical airport reference code expected to use the runway. The dimensional standards are outlined for the planning period runways serving Lincoln Airport.

Runway Length

The aircraft performance capability is a key factor in determining the runway length needed for takeoff and landing. The performance capability and, subsequently, the runway length requirement of a given aircraft type can be affected by the elevation of the airport, the air temperature, the gradient of the runway, and the operating weight of the aircraft. Aircraft performance declines as each of these factors increase.

The airport elevation at Lincoln Airport is 1,219 feet above mean sea level (MSL). The temperature commonly used for design is the mean maximum daily temperature during the hottest month. According to the National Weather Service, that is 88.5 degrees

Fahrenheit (F) in Lincoln during the month of July. The change in elevation (gradient) varies by 20.5 feet along Runway 18-36 (0.16 percent gradient), by 42.8 feet along Runway 17-35 (0.79 percent gradient), and 21.8 feet along Runway 14-32 (0.24 percent gradient). This information is utilized in the following runway length analyses.

At least one runway should have the capability to handle the most demanding aircraft with regards to runway length. Thus, the following discussion considers the most demanding runway length requirements now and in the future.

The aircraft load is dependent upon the payload of passengers and/or cargo, plus the amount of fuel it has on board. For departures, the amount of fuel varies depending upon the length of non-stop flight or trip length. As of June 2006, there were two weekly non-stop flights by the passenger airlines to destinations over 1,000 miles from LNK. This is represented by the service provided by Allegiant Air utilizing an MD-83 aircraft.

Table 3H indicates the existing and potential non-stop haul length from Lincoln Airport. Currently, only the Las Vegas destination is greater than 1,000 air miles. In the future, destinations such as Phoenix and Washington, D.C., would exceed 1,000-mile haul lengths. Thus, runway length requirements will consider fully loaded passenger aircraft with haul lengths over 1,000 miles.

TABLE 3H
Non-Stop Commercial Service Haul Lengths (over 300 miles)
Lincoln Airport

| Existing Non-Stops | Air Miles | Potential Non-Stops | Air Miles |
|--------------------|-----------|---------------------|-----------|
| Chicago | 479 | Dallas-Ft. Worth | 515 |
| Denver | 440 | Phoenix | 1,038 |
| Minneapolis | 332 | Atlanta | 840 |
| Detroit | 717 | Salt Lake City | 797 |
| Las Vegas | 1,050 | Washington D.C. | 1,029 |

Table 3J outlines the runway length requirements at maximum takeoff weight (MTOW) for key passenger commercial jets at LNK's design temperature. The still air range in statute miles is also given for each aircraft listed. The current 12,900-foot runway length is adequate for the key

passenger aircraft. Only very long range wide body aircraft, under fully loaded conditions may require more runway length. If any of the wide body aircraft were to operate at the airport, they would simply take on less load on those hottest days and make an intermittent stop if necessary.

TABLE 3J
Take-off Length Requirements
Lincoln Airport

| | Runway Length | Range (miles) |
|--------------------|---------------|---------------|
| Narrow body | | |
| CRJ700ER | 7,200 | 2,239 |
| MD-83 | 10,500 | 2,520 |
| B737-300 | 8,500 | 1,635 |
| B757-200F | 10,000 | 3,150 |
| B707-320C | 13,500 | 4,900 |
| ERJ 145LR | 9,700 | 1,780 |
| Wide body | | |
| B747-400F | 13,200 | 4,445 |
| A380 | 12,100 | 9,200 |
| DC-10 Series 40 | 13,300 | 4,830 |
| MD-11 | 13,000 | 7,070 |

Assumptions:

MTOW: Maximum Take-off Weight

Temperature: 89.5° F; Elevation: 1,219; Gradient: 0.16%

Source: Aircraft operational manuals; FAA Central Region Runway Length Formula

The Boeing 707 listed in the table is representative of the KC-135R aircraft based at the airport by the guard unit. These aircraft would be fully capable of performing refueling missions the majority of the year. Only on the hot-

test days would they likely have to take on slightly less fuel. The current runway length of 12,900 feet is capable of accommodating most civilian passenger aircraft and military aircraft.

The current length of Runway 18-36 exceeds the need of most aircraft currently using or forecast to use the runway. The current length does lend flexibility to current and future users, as well as a suitable emergency landing site for NASA's Space Shuttle. Its continued maintenance cost, however, may not be fully provided by the FAA. Typically, the FAA will only support the costs associated with pavement improvements required by the airport's critical aircraft. For LNK, a length of at least 10,500 feet should be justifiable to the FAA for grant funding assistance. As noted above, runway length analysis indicated a need for 10,500 feet to meet

the requirements of the MD-83 aircraft utilized by Allegiant Air.

Runway 17-35 is designed to serve the basic needs of general aviation aircraft. In this manner it provides improved airfield capacity and safety by separating general aviation operations from commercial service and military operations. **Table 3K** outlines the runway length requirements for various groupings of general aviation aircraft. The current runway length of 5,400 feet serves the needs of 75 percent of business jets at 60 percent useful load. This is the most basic planning standard for a general aviation runway serving large business jets.

| TABLE 3K General Aviation Runway Length Analysis Lincoln Airport | |
|--|--------------------------|
| AIRPORT AND RUNWAY DATA | |
| Airport Elevation..... | 1,219 feet |
| Mean daily maximum temperature..... | 89.5° F |
| Maximum difference in runway centerline elevation..... | 42.8 feet |
| Length of haul length for airplanes of more than 60,000 pounds..... | 1,000 miles |
| Wet and slippery runways | |
| RUNWAY LENGTHS RECOMMENDED FOR AIRPORT DESIGN | |
| Small airplanes with less than 10 passenger seats | |
| 75 percent of these small airplanes..... | 3,000 feet |
| 95 percent of these small airplanes..... | 3,500 feet |
| 100 percent of these small airplanes..... | 4,100 feet |
| Small airplanes with 10 or more passenger seats..... | 4,500 feet |
| Large airplanes of 60,000 pounds or less | |
| 75 percent at 60 percent useful load..... | 5,300 feet |
| 75 percent at 90 percent useful load..... | 7,200 feet |
| 100 percent at 60 percent useful load..... | 6,200 feet |
| 100 percent at 90 percent useful load..... | 9,200 feet |
| Airplanes of more than 60,000 pounds..... | approximately 6,500 feet |
| <i>Reference: Chapter Two of AC 150/5325-4A, Runway Length Requirements for Airport Design</i> | |

The large aircraft maintenance operation located on the east ramp has a national and international client base. It is not unusual for aircraft owners based in Europe or South America to utilize the service of this FBO at Lincoln. When conditions are such that the pilot of a business jet requires a longer runway length than is provided by Runway 17-35, the primary runway is available. Thus, the existing length of 5,400 feet for Runway 17-35 is adequate through the long term planning period.

Runway Width

Primary Runway 18-36 is 200 feet wide. This width exceeds the 150-foot FAA standard for runways designed to accommodate aircraft in ARC D-IV. Prior to the next major runway rehabilitation or overlay project the necessity of maintaining a 200-foot wide runway should be evaluated. A benefit/cost analysis of maintaining the 200-foot width versus the expense of narrowing to 150 feet will be presented in the alternatives chapter.

Crosswind Runway 14-32 is 150 feet wide and parallel Runway 17-35 is 100 feet wide. Both of these widths are adequate to meet the applicable design standards for their associated design aircraft.

Pavement Strength

An important feature of airfield pavement is its ability to withstand repeated use by aircraft of significant weight. At Lincoln Airport, pavement

must be able to support multiple operations of large commercial and military jet aircraft on a daily basis.

The current strength rating on Runway 18-36 is 100,000 pounds single wheel loading (SWL), 200,000 dual wheel loading (DWL), and 400,000 pounds dual tandem wheel loading (DTWL). The current critical commercial passenger aircraft, the MD-83, has a dual wheel configuration and a maximum gross weight of 163,000 pounds. The CRJs, with SWL configurations, have a gross weight of less than 100,000 pounds. The B757, a DTWL configured aircraft, has a maximum gross weight of 224,000 pounds. The KC-135 tanker has a DTWL configuration and a maximum gross weight of 322,500 pounds. Thus, the primary runway strength is adequate and should be maintained in the future.

Runway 14-32 is currently strength-rated at 80,000 pounds SWL, 170,000 pounds DWL, and 280,000 pounds DTWL. This strength is adequate to accommodate the entire fleet of CRJs currently operating as well as the current critical passenger aircraft, the MD-83. If larger and heavier commercial aircraft return to regular operation at the airport, consideration should be given to increasing the strength of the crosswind runway to that of the primary runway.

Runway 17-35 is primarily utilized by general aviation aircraft and is strength-rated at 49,000 pounds SWL and 60,000 pounds DWL. This strength-rating is capable of accommodating regular activity by the vast

majority of business jets. The largest business jets, such as many Gulfstream models, exceed this strength-rating. These aircraft could adequately be served by both the primary and crosswind runways.

Taxiways

Taxiways are primarily constructed to facilitate aircraft movements to and from the runway system. Parallel taxiways greatly enhance airfield capacity and are essential to aircraft movement on the ground. Some taxiways are necessary simply to provide access to apron and terminal areas, while others are designed to facilitate the movement of aircraft to and from the runways. As activity increases, additional taxiways become necessary to provide for safe and efficient use of the airfield. The taxiway system at LNK consists of parallel taxiways serving each runway, exit taxiways, and access taxiways connecting the airfield to the various aircraft ramps.

All runways have at least one parallel taxiway, while primary Runway 18-36 provides both east and west parallel taxiways. Parallel taxiways greatly enhance airfield capacity and are essential to efficient aircraft movement on the airfield.

Runway 18-36 is served by parallel Taxiway G to the west and Taxiway D to the east. Taxiways D and G are 75 feet wide, meeting FAA standards for taxiways serving a critical aircraft in ARC D-IV. Taxiway D is separated from the runway at distances varying from 600 feet to 775 feet. Taxiway G

is separated from the runway by 1,025 feet. The minimum separation standard for these taxiways is 400 feet.

The type and frequency of taxiway exits can affect the efficiency and capacity of the runway system. Runway 18-36 provides exits at each end of the runway and several midfield exits. Taxiways J and K are acute angle, high-speed exits connecting to parallel Taxiway D, while Taxiway H is a right angle exit available to the east. Taxiways E and S are right angle exits providing access to Taxiway G and the west ramp area.

Although the spacing of these exits is adequate, the frequency of exits is limited. High-speed exits should be considered near midfield to improve exit efficiency for commercial and military aircraft. At least one additional west side exit should be considered if west ramp activity increases. All exits from the primary runway are 75 feet wide and should be maintained at this width.

Taxiways serving the crosswind runway should be planned to a similar standard as those serving the primary runway. Parallel Taxiway J is 75 feet wide and is separated from the runway centerline by at least 400 feet. Taxiways G, D, and K are also 75 feet wide and each is a midfield exit from the runway. The taxiway system serving crosswind Runway 14-32 is adequate and should be maintained.

Runway 17-35 is served by parallel Taxiway A to the east. The southern half of the taxiway from the intersection with Taxiway K is 75 feet wide, while the northern half is 50 feet wide.

The standard for accommodating a general aviation critical aircraft in ARC D-II is 50 feet wide. The larger business jets fall in Design Group III, which requires a taxiway width of 50 feet. Thus, Taxiway A should remain at least 50 feet wide.

Taxiways E, K, and N connect to Taxiway A and onto the east ramp area. Because each of these exits can also be utilized to connect to other areas of the airport, they will be traversed by Design Group II aircraft. Therefore, it is recommended that they be maintained at 50 feet in width. The continuation of Taxiways E, K, and N to the crosswind runway and points to the west is extremely useful in reducing taxi distances, thus improving airfield capacity.

Hold aprons or bypass taxiways can improve the efficiency of the taxiway system. Runway 17-35 has hold apron on both ends of Taxiway A. Runway 36 is served by a hold apron on the west side. The center area of Taxiway N between Runway 17-35 and Runway 14-32 has a small hold apron. The length available for holding is approximately 75 feet, thus this apron is only available for small general aviation aircraft holding for Runway 32.

One primary issue which should be addressed is the alignment of Taxiways D and E. Aircraft which taxi between the general aviation ramp and Runway 18-36 must taxi onto Runway 14-32 then to Taxiway D. Alternative analysis will consider routing Taxiway E to intersect directly with Taxiway D without requiring aircraft to enter Runway 14-32. This improvement will

increase capacity and improve operational efficiency of the airfield.

AIRFIELD “HOT SPOTS”

A runway incursion is "any occurrence at an airport involving an aircraft, vehicle, person or object on the ground that creates a collision hazard or results in a loss of separation with an aircraft taking off, intending to take off, landing, or intending to land." The FAA has identified runway incursions as a serious aviation safety issue. The decreasing of runway incursions and improving of airport surface operations is a “Top Five” agency safety initiative.

While there may be broad causal factors at the root of runway incursions, most incidents result from characteristics unique to each airport, which may include layout, local procedures, traffic mix, and airport location. Identifying specific causes at each airport becomes crucial to improving its level of runway safety.

The FAA has identified those local conditions that could potentially lead to runway incursions at Lincoln Airport. **Exhibit 3E** presents the identified “Hot Spots.” The first identified hot spot is the confluence of Taxiways J, D, and E with Runways 18-36 and 14-32. This area can be confusing to pilots unfamiliar with the airport. Some designated hot spots are simply identified for pilot information purposes. For example, hot spot #2 points out that the parallel runways have been re-designated to 18-36 for the

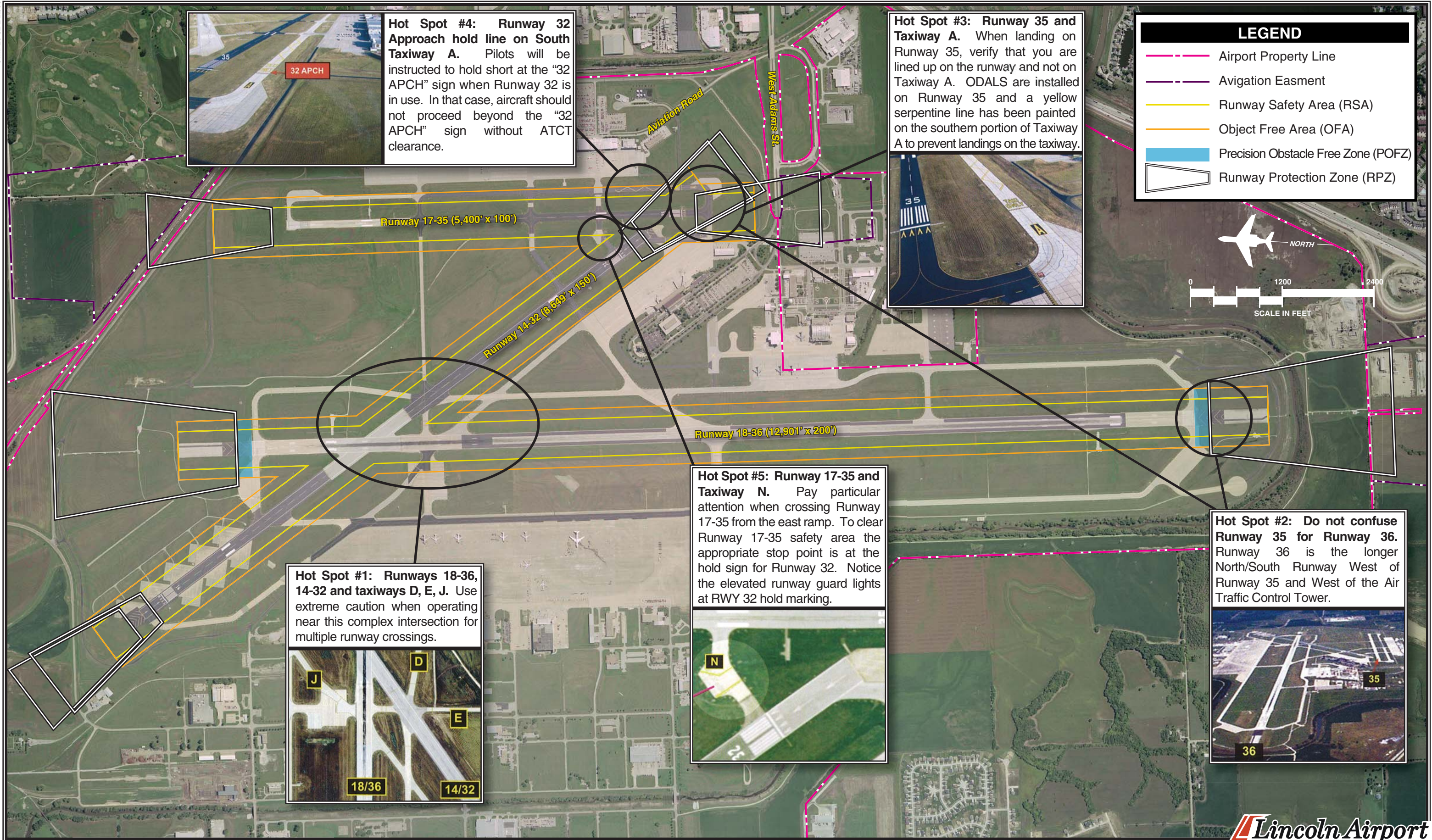

Hot Spot #4: Runway 32 Approach hold line on South Taxiway A. Pilots will be instructed to hold short at the "32 APCH" sign when Runway 32 is in use. In that case, aircraft should not proceed beyond the "32 APCH" sign without ATCT clearance.

Hot Spot #3: Runway 35 and Taxiway A. When landing on Runway 35, verify that you are lined up on the runway and not on Taxiway A. ODALS are installed on Runway 35 and a yellow serpentine line has been painted on the southern portion of Taxiway A to prevent landings on the taxiway.



LEGEND

- Airport Property Line
- Avigation Easment
- Runway Safety Area (RSA)
- Object Free Area (OFA)
- Precision Obstacle Free Zone (POFZ)
- Runway Protection Zone (RPZ)

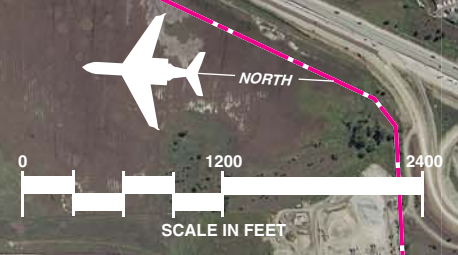

Hot Spot #1: Runways 18-36, 14-32 and taxiways D, E, J. Use extreme caution when operating near this complex intersection for multiple runway crossings.



Hot Spot #5: Runway 17-35 and Taxiway N. Pay particular attention when crossing Runway 17-35 from the east ramp. To clear Runway 17-35 safety area the appropriate stop point is at the hold sign for Runway 32. Notice the elevated runway guard lights at RWY 32 hold marking.

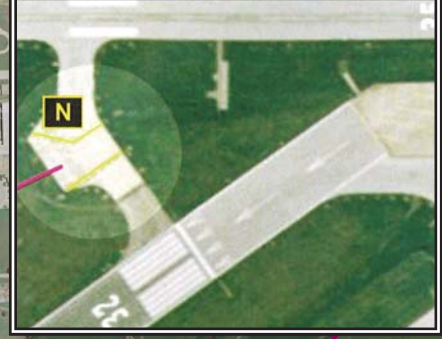

Hot Spot #2: Do not confuse Runway 35 for Runway 36. Runway 36 is the longer North/South Runway West of Runway 35 and West of the Air Traffic Control Tower.



primary runway and 17-35 for the general aviation runway.

The third hot spot is the potential confusion between Taxiway A and the Runway 35 threshold. In the past, pilots have landed on Taxiway A, mistaking it for the runway. Several pavement markings have been applied to alleviate the confusion. A large boxed 'A' appears on the taxiway, the words "TAXI ONLY" are also marked. Finally, a non-standard serpentine yellow line approximately 700 feet long notifies pilots that this pavement is not the runway. The FAA is utilizing this nonstandard marking at Lincoln as a national pilot program to assess the effectiveness of the marking.

The fourth hot spot is the Runway 32 approach hold line on the south end of Taxiway A. This is unusual in that hold lines are typically associated with the immediately adjacent runway. In this case, when Runway 32 is in use, pilots may be asked to hold at the "32 Approach" sign before being allowed to taxi to Runway 35.

The final hot spot is the hold apron on Taxiway N between Runway 17-35 and 14-32. The hold lines overlap in this area, thus, when holding in this area it is necessary to cross one set of hold lines and stop prior to the second set.

SAFETY AREA DESIGN STANDARDS

The FAA has established several safety surfaces to protect aircraft operational areas and keep them free

from obstructions that could affect their safe operation. These include the runway safety area (RSA), object free area (OFA), obstacle free zone (OFZ), and runway protection zone (RPZ).

The entire RSA, OFZ, and OFA should be under the direct control of the airport sponsor to ensure these areas remain free of obstacles and can be readily accessed by maintenance and emergency personnel. It is not required that the RPZ be under airport ownership, but it is strongly recommended. An alternative to outright ownership of the RPZ is the purchase of aviation easements (acquiring control of designated airspace within the RPZ) or having sufficient land use control measures in places which ensure the RPZ remains free of incompatible development. **Exhibit 3E** visually depicts the existing runway safety areas at Lincoln Airport.

Dimensional standards for the various safety areas associated with the runways are a function of the type of aircraft (ARC) expected to use the runways, as well as the approved instrument approach visibility minimums. Each runway can be designed to serve a different type of aircraft based on ARC. At Lincoln Airport, Runway 18-36 is the designated primary runway and should meet design standards for ARC D-IV. Runway 14-32 should meet design standards for ARC D-III and Runway 17-35 should meet design standards for aircraft in ARC D-II.

Because the airport serves scheduled commercial service, the crosswind runway should adhere to the same de-

sign standards as the primary runway, where possible.

Runway Safety Area (RSA)

The RSA is defined in FAA Advisory Circular (AC) 150/5300-13, *Airport Design*, Change 10, as a “surface surrounding the runway prepared or suitable for reducing the risk of damage to airplanes in the event of an undershoot, overshoot, or excursion from the runway.” The RSA is centered on the runway and dimensioned in accordance to the approach speed of the critical aircraft using the runway. The FAA requires the RSA to be cleared and graded, drained by grading or storm sewers, capable of accommodating the design aircraft and fire and rescue vehicles, and free of obstacles not fixed by navigational purpose.

The FAA has placed a higher significance on maintaining adequate RSAs at all airports. Under Order 5200.8, effective October 1, 1999, the FAA established the *Runway Safety Area Program*. The Order states, “The objective of the Runway Safety Area Program is that all RSAs at federally-obligated airports . . . shall conform to the standards contained in Advisory Circular 150/5300-13, *Airport Design*, to the extent practicable.” Each Regional Airports Division of the FAA is obligated to collect and maintain data on the RSA for each runway at the airport, and perform airport inspections.

For runways serving a critical aircraft in approach categories C and D, as all

runways at Lincoln Airport do, the RSA must be 500 feet wide, centered on the runway, and extend 1,000 feet beyond the end of the runway. The RSA is required to extend 600 feet prior to the landing threshold.

RSA standards are currently met beyond all runway ends except for the RSA behind Runway 36. The localizer is currently a penetration to the standard RSA surface. Relocation of the localizer is scheduled for early 2007. The alternatives analysis will thus be completed assuming that all RSA standards are met.

Object Free Area (OFA)

The runway OFA is “a two-dimensional ground area, surrounding runways, taxiways, and taxilanes, which is clear of objects except for objects whose location is fixed by function (i.e., airfield lighting).” The OFA does not have to be graded and level as does the RSA; instead, the primary requirement for the OFA is that no object in the OFA penetrate the lateral elevation of the RSA. The runway OFA is centered on the runway, extending out in accordance to the critical aircraft design category utilizing the runway.

For all runways with a critical aircraft in approach categories C and D, the OFA must be 800 feet wide, centered on the runway, and extend 1,000 feet beyond the runway pavement end. Currently, the electrical vault located near Runway 36 penetrates the OFA surface. This vault should be relocated when the localizer is relocated.

A small portion of the service road to the north and west of the Runway 14 end may penetrate the OFA. The alternatives chapter will provide solutions if the OFA is penetrated.

The south service road crosses the southwestern corner of the Runway 14-32 OFA and then the southwestern portion of Runway 17-35 OFA. This OFA penetration has previously been addressed with the FAA and a modification to standards was accepted on February 28, 2001.

Obstacle Free Zones (OFZ)

The OFZ is an imaginary surface which precludes object penetrations, including taxiing and parked aircraft. The only allowance for OFZ obstructions is navigational aids mounted on frangible bases which are fixed in their location by function such as airfield signs. The OFZ is established to ensure the safety of aircraft operations. If the OFZ is obstructed, the airport's approaches could be removed or approach minimums could be increased.

For all runways serving aircraft over 12,500 pounds, the OFZ is 400 feet wide, centered on the runway, and extends 200 feet beyond the runway ends. This standard will apply to all runways at LNK. Currently, there are no OFZ obstructions at Lincoln Airport. Future planning should maintain the OFZ for the appropriate runway type.

Precision Obstacle Free Zone (POFZ)

For runways providing a vertically-guided approach, a precision obstacle free zone (POFZ) is required. The POFZ is defined as "a volume of airspace above an area beginning at the runway threshold, at the threshold elevation, and centered on the extended runway centerline, 200 feet long by 800 feet wide." The POFZ is only in effect when the following operational conditions are met:

- I. Vertically-guided approach
- II. Reported ceiling below 250 feet and/or visibility less than three-quarters-of-a-statute-mile
- III. An aircraft on final approach within two (2) miles of the runway threshold

When these conditions are met, aircraft holding for take-off must hold in such a position so that neither the fuselage nor the tail of the aircraft penetrates the POFZ. The wings of the aircraft are allowed to penetrate the surface. Both ends of Runway 18-36 are supported by a precision ILS approach, thus POFZ standards will apply to these runway ends when conditions are met. This runway currently meets POFZ requirements.

Runway Protection Zones (RPZ)

The RPZ is a trapezoidal area centered on the runway, typically beginning 200 feet beyond the runway end.

The RPZ has been established by the FAA to provide an area clear of obstructions and incompatible land uses, in order to enhance the protection of approaching aircraft as well as people and property on the ground. The dimensions of the RPZ vary according to the visibility minimums serving the runway and the type of aircraft oper-

ating on the runway. The dimensions of the RPZs at Lincoln Airport are presented in **Table 3L**. The airport has and should maintain positive control over all of the land within the RPZs. If Runway 14-32 or Runway 17-35 were to be served by lower visibility minimums as proposed, larger RPZs would be required.

TABLE 3L
Runway Protection Zones
Lincoln Airport

| | Runway 18-36 | Runway 14-32 | Runway 17-35 |
|-----------------------------|---------------------|---------------------|---------------------|
| Approach Visibility Minimum | 1/2 Mile | 1 Mile | 1 Mile |
| Inner Width | 1,000 | 500 | 500 |
| Outer Width | 1,750 | 1,010 | 1,010 |
| Length | 2,500 | 1,700 | 1,700 |

Source: FAA AC 150/5300-13, Airport Design, Change 10

INSTRUMENT AND VISUAL NAVIGATIONAL AIDS

Navigational aids provide two primary services to airport operations: precision guidance to a specific runway and/or non-precision guidance to a runway or the airport itself. The basic difference between a precision and non-precision navigational aid is that the former provides electronic descent, alignment (course), and position guidance, while the non-precision navigational aid provides only alignment and position location information. The necessity of such equipment is usually determined by design standards predicated on safety considerations and operational needs. The type, purpose, and volume of aviation activity expected at the airport are factors in the determination of the airport's eligibility for navigational aids.

The advancement of technology has been one of the most important factors in the growth of the aviation industry in the twentieth century. Many of the civil aviation improvements have been derived and enhanced from initial development for military purposes. The use of orbiting satellites to confirm an aircraft's location is one of the latest military developments to be made available to the civil aviation community.

Global Positioning Systems (GPS) use two or more satellites to derive an aircraft's location by a triangulation method. The accuracy of these systems has been remarkable, with initial degrees of error of only a few meters. GPS approaches are available to Runways 18, 36, 14, and 17, with visibility minimums down to one mile.

As the technology improves, it is anticipated that GPS may be able to provide accurate enough position information to allow Category I (one-half mile visibility and 200-foot cloud ceilings) precision instrument approaches, independent of any existing ground-based navigational facilities. In addition to the navigational benefits, GPS equipment is much less costly than existing precision instrument landing systems (ILS) involving a glide slope, localizer antennae, and middle and outer markers and an approach lighting system. Currently, ILS approaches are available to both ends of Runway 18-36.

Approaches to Runway 17 and 18 utilizing the Lincoln VOR facility located approximately four miles to the north of the airport allow for visibility minimums not lower than one mile. The Potts non-directional beacon (NDB) allows for non-precision instrument approaches to Runway 36. For small aircraft in approach categories A & B, visibility minimums are not lower than three-quarters mile. The Potts NDB is scheduled to be decommissioned in 2008.

Ideally, the airport should plan for at least Category I minimums on all approaches to runways used by commercial airlines and business jet operators. This will ensure the maximum flexibility for future instrument operations. With improved GPS minimums in the future, the cost for Category I equipment will be minimal. The key will be ensuring that the approaches are maintained and the runway meets the other standards necessary to provide for CAT I minimums.

The current approaches are adequate for at least the short term. Consideration should be given to implementing CAT I approach minimums for Runway 14-32 and not lower than three-quarters mile minimums for the parallel Runway 17-35. It should be noted, however, that Runways 32 and 35 have displaced landing thresholds. The displacements were done in the past due to obstructions to flight. Analysis to be conducted in the next chapter will determine if the obstructions remain and/or if the thresholds can be returned to the runway pavement ends.

Visual glide slope indicators provide visual descent guidance information during approach. There are two forms of these aids that have been regularly installed by the FAA at airports. They include precision approach path indicators (PAPI) and visual approach path indicators (VASI). Both types are in use at Lincoln, with both parallel runways offering PAPI-4Ls and Runway 14-32 offering the VASI-4L. In the future, the VASIs serving Runway 14-32 should be upgraded to PAPIs.

AIRFIELD LIGHTING, MARKING, AND SIGNAGE

To achieve the Category I minimums, an approach light system such as a medium intensity approach light system with runway alignment indicator lights (MALSR) is necessary. Both Runway 18 and Runway 36 have a MALSR. High intensity runway edge lights (HIRL) are recommended for CAT I runways used by commercial

jets. Runway 18-36 is currently equipped with HIRL, as is parallel Runway 17-35. Runway 14-32 has medium intensity runway lighting. All runway edge lighting should be maintained.

Runway identification lighting provides the pilot with a rapid and positive identification of the runway end. The most basic system involves runway end identifier lights (REILs). REILs can be considered for all lighted runway ends not planned for a more sophisticated approach light system (ALS). There are currently REILs on Runway 14 and Runway 17. The REILS should be maintained unless the approach minimums are to be lowered. If a CAT I approach is to be implemented on Runway 14-32, a MALS R will need to be installed.

Runway 35 currently provides an ODALS approach lighting system. This basic approach light system enhances the safety of approaching aircraft and should be maintained.

Medium intensity taxiway lighting (MITL) is currently in place on all airfield taxiways and should be planned for all future taxiways.

Lighted airfield signage currently conforms to FAR Part 139 standards. Precision runway marking is in place on Runways 18-36, while there are non-precision markings on the other two runways. These markings will be adequate until such a time that precision approaches to either the crosswind runway or the parallel runway are sought.

The airport maintains a universal rotating beacon located on the west side of the airport. This beacon provides rapid identification of the airport environment for pilots and should be maintained.

WEATHER AND COMMUNICATION INFORMATION

As discussed in Chapter One – Inventory, Lincoln Airport is equipped with five lighted wind cones. The wind cones provide information to pilots regarding wind conditions, such as direction and intensity. Two of the wind cones serve the east ramp area. One is located to the north between Runway 17-35 and Taxiway A and the second is similarly positioned to the south. A third lighted wind cone is located near the glide slope antennae serving Runway 18. The fourth wind cone is located to the side of the approach to Runway 14. These wind cones are appropriately placed and should be maintained. The fifth wind cone is located to the west of the Runway 36 threshold.

Lincoln Airport is equipped with an Automated Surface Observing System (ASOS). An ASOS will automatically record weather conditions such as temperature, dew point, wind speed, altimeter setting, visibility, sky condition, and precipitation. The ASOS updates observations each minute 24 hours a day, and this information is transmitted to pilots in the airport vicinity via FAA VHF ground-to-air radio. Pilots can receive these broad-

casts (via a local telephone number), where a computer-generated voice will present airport weather information. The airport is also equipped with a low level wind shear alert system (LLWAS). The LLWAS is designed to identify significant changes in wind patterns at low altitudes surrounding the airport and alert aircraft of the potential danger. Both of these systems should be maintained.

Lincoln Airport is served by the Automated Terminal Information Service (ATIS). ATIS broadcasts are updated hourly and provide arriving and departing pilots the current surface weather conditions, communication frequencies, and other important airport-specific information. The ATIS system should be maintained.

The airport also provides a Remote Communications Outlet which allows the filing of flight plans from the aircraft when the ATCT is closed. This system should be maintained.

PASSENGER TERMINAL COMPLEX REQUIREMENTS

Components of the terminal area complex include the terminal building, gate positions, and apron area. This section identifies the facilities required to meet the airport's needs through the planning period.

The review of the capacity and requirements for various terminal complex functional areas was performed with guidance from FAA AC 150/5360-13, *Planning and Design Guidelines for Airport Terminal Facilities*. Facil-

ity requirements were updated to reflect the planning horizon for enplanement milestones. This included the enplanement levels of 252,000, 281,000, and 351,000 annual enplaned passengers.

Airline terminal capacity and requirements were developed for the following functional areas:

- Airline Ticketing and Operations
- Departure Facilities
- Baggage Claim
- Terminal Services
- Public Use Areas and Security
- Administration/Support

TICKETING AND AIRLINE OPERATIONS

The first destination for enplaning passengers in the terminal building is usually the airline ticket counter. The ticketing area consists of the ticket counters, queuing area for passengers in line at the counters, and the ticket lobby which provides circulation.

The ticket lobby should be arranged so that the enplaning passenger has immediate access and clear visibility to the individual airline ticket counters upon entering the building. Circulation patterns should allow the option of bypassing the counters with minimum interference. Provisions for seating should be minimal to avoid congestion and to encourage passengers to proceed to the gate area. Airline ticket counter frontage, counter area, counter queuing area, ticketing lobby and airline office and operations area

requirements for each potential enplanement level have been calculated.

The analysis of the airline ticketing lobby indicates that the area would provide adequate area through the short term planning period if the area was dedicated for these purposes. At the Lincoln Airport, this area is also utilized by the Transportation Security Administration (TSA) for baggage screening. During peak periods, the ticket lobby may become congested because of the dual use of this area. Terminal planning will consider options for relocations of the TSA baggage screening functions.

Once the enplanement levels approach intermediate and long term levels, however, there may be customer congestion at the ticket counters. At peak times, such as Wednesdays around the noon hour, the existing ticket counters will experience some congestion. As shown on **Exhibit 3F**, by the long term planning period as much as 800 square feet of additional ticket lobby area may be necessary.

The airline counter area may also become inadequate if the long term enplanement forecasts are realized. Analysis indicates that baggage preparation areas are adequate through the long term planning period.

DEPARTURE GATES AND HOLDROOMS

At the present time, there are four gate positions with enclosed jetways to serve the commercial passenger air-





line operators at the airport. These jetways have the capability for expansion to a total of eight loading bays. There are an additional two lower level commuter loading gates available, but they are currently not utilized. Long range planning considers the potential addition of two carriers at the airport. The number of gates available will be adequate through the long range planning period.

Holdroom facilities are located on the second level at the north and south ends of the terminal building. Each holdroom is approximately 4,100 square feet in area. The existing holdroom area should be adequate through the long term planning period.

The apron at the terminal building is currently able to accommodate four full-size jet aircraft. It has the capability to accommodate eight aircraft. The terminal building ramp should be adequate through the long term planning period.

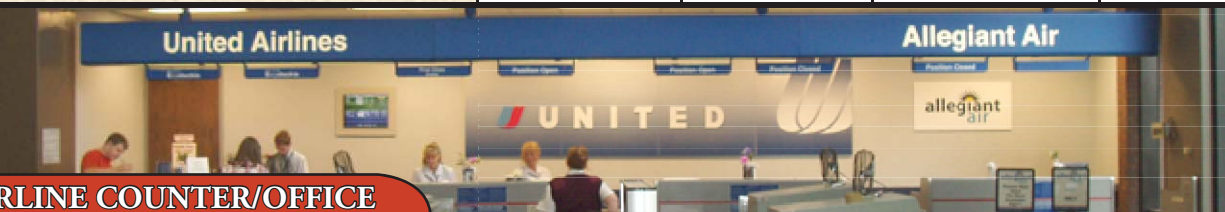
BAGGAGE CLAIM

Passenger baggage claim facilities are located on the ground level of the terminal building. There are two baggage claim carousels providing a total of 180 feet of linear space. The baggage claim lobby is determined by taking into consideration the number of deplaning passengers during the peak hour and the estimated number of visitors greeting arriving passengers. There is approximately 5,650 square feet of baggage claim lobby available. Because of the significant peak activ-

| PLANNING HORIZON ENPLANEMENTS | CURRENT | SHORT TERM | INTERMEDIATE TERM | LONG TERM |
|--|-----------------|----------------|-------------------|----------------|
| | | →252,000 | 281,000 | 351,000 |
|  | | | | |
| AIRLINE COUNTER/OFFICE | | | | |
| Counter Area (s.f.) | →1,100 | 1,345 | 1,457 | 1,606 |
| Ticket Lobby Que (s.f.) | →3,210 | 3,362 | 3,642 | 4,014 |
| Airline Operations/Baggage (s.f.) | →9,510 | 7,011 | 7,262 | 8,595 |
| DEPARTURE FACILITIES | | | | |
| Holdroom Area (s.f.) | →8,200 | 6,624 | 7,175 | 7,908 |
| BAGGAGE CLAIM | | | | |
| Baggage Claim Area (s.f.) | →5,650 | 12,476 | 13,318 | 14,462 |
|  | | | | |
| TERMINAL SERVICES | | | | |
| Rental Car Lobby Que (s.f.) | →665 | 451 | 474 | 504 |
| Rental Car Office Area (s.f.) | →1,170 | 1,503 | 1,578 | 1,678 |
| Food and Beverage (s.f.) | →4,400 | 11,855 | 12,623 | 13,673 |
| Retail (s.f.) | →1,200 | 1,482 | 1,578 | 1,709 |
| Restrooms (s.f.) | →1,650 | 1,600 | 1,704 | 1,846 |
|  | | | | |
| PUBLIC USE AREAS AND SECURITY | | | | |
| Public Lobby | →5,000 | 4,742 | 5,049 | 5,469 |
| Greeting Lobby | →800 | 1,048 | 1,096 | 1,165 |
| Circulation | →37,200 | 31,000 | 33,000 | 36,000 |
| Security Queuing Area | →3,400 | 3,556 | 3,787 | 4,102 |
| ADMINISTRATION AND OTHER | | | | |
| Offices, Conference Rooms | →2,000 | 2,530 | 2,820 | 3,520 |
| HVAC/Mechanical | →20,000 | 14,900 | 15,900 | 17,575 |
|  | | | | |
| AUTO PARKING | | | | |
| Terminal Curb (l.f.) | →400 | 587 | 636 | 701 |
| Public Parking Spaces | →740 | 749 | 825 | 1,002 |
| Rental Car Return | →124 | 172 | 192 | 240 |
| Employee | →170 | 126 | 141 | 176 |
| GROSS TERMINAL AREA | →100,800 | 100,600 | 107,300 | 118,600 |

ity experienced around the noon hour, the baggage claim lobby may become congested. When this is the case, passengers and their party will typically spread into other areas of the terminal building as needed. Although baggage claim lobby calculations indicate a need for greater space, the fact that congestion occurs at very predictable periods, allows for temporary use of other terminal building space for baggage claim needs. Moreover, if enplanements increase as projected, it is likely that additional flights will be required to accommodate the demand. The new flights would be spread throughout the day and should not create a higher peak than currently exists.

TERMINAL SERVICES

Similar to airline ticketing, rental car counter facilities include office, counter area, and queue areas. There are currently six counters identified for rental car services. Combined, approximately 665 square feet of rental car area lobby queue is available. Three additional booths are available for rental car expansion if necessary. This is forecast to be adequate through the long term. Rental car office space may become constrained; however, there are additional offices available should demand dictate.

Concessions are available on the second floor of the terminal building. The restaurant was recently remodeled to allow for more open and inviting seating. Calculations for concessions are based primarily on peak hour enplanements. Again, with the significant peak experienced around the

noon hour, the restaurant may become crowded and congested.

Calculations indicate that the gift shop area is currently adequate, but more space may be needed through the long term planning period.

The recent remodeling of the second floor of the terminal added restrooms to each side of the elevators. Now there are second floor public restrooms as well as restrooms accessible from the secured holdrooms. Overall, restroom facilities appear adequate through the long term planning period.

PUBLIC-USE AREA AND SECURITY SCREENING

The public lobby is where passengers or visitors may comfortably relax while waiting for arrivals or departures. In today's post 9/11 environment, visitors must remain outside of the secure departure areas, so a public lobby is important. The terminal building provides more than 5,000 square feet of space for this purpose on the first floor of the terminal building. Only in the long term does this area become constrained.

Greeting lobby space is considered that area where arriving passengers first meet those visitors awaiting their arrival. This area is typically immediately outside security stations. At Lincoln Airport, the area immediately outside the security checkpoints can experience long lines at peak times. As a result, only a small portion of the second floor concourse is considered

for greeting lobby area, while some areas on the first floor are also considered. Greeting area appears adequate through the long term planning periods.

There are two security screening checkpoints, with one located at the entrance to each holdroom on the second floor. The queuing area prior to the security checkpoints includes a large portion of the second floor hallway during peak periods. During these peaks, lines can extend from the checkpoints to the elevators. Typically, it is appropriate for offices to be available immediately adjacent the security checkpoints for security personnel. Under the current configuration, the offices for security personnel are located on the first floor. If long term enplanement levels are met, then the adequacy of the existing security checkpoints may need to be reexamined.

BUILDING SUPPORT AND ADMINISTRATION

A common feature of modern terminal buildings is the availability of public conference room facilities. In a business environment where a corporate official may visit many cities during a single day, the ability to meet clients or colleagues at the airport for private meetings can be an advantage. A public banquet/conference room is available on the second floor of the terminal building.

The needs of airport administration should also be considered when planning the airport terminal building.

Office space is difficult to calculate as the needs of each airport will vary, but analysis indicates that additional office space may be necessary at Lincoln Airport.

The basement houses the majority of heating, ventilating, and air conditioning (HVAC) mechanics. The HVAC facilities appear to be of an adequate size to handle growth in enplanement levels.

Finally, the public circulation patterns should be addressed. At peak periods, congestion can build up in certain areas of the terminal building. At these congested areas, circulation areas (i.e., hallways, passages) will become congested as well. Circulation provided in the terminal building appears adequate through the long term planning period.

Effective circulation patterns will locate terminal services in such a manner as to avoid conflicting traffic patterns by people with differing destinations. For example, those entering the airport for departure should be able to flow from the entrance to the ticket counter to security screening and finally to the secure hold areas. Those waiting to greet arriving passengers should be able to do so without disrupting the flow of passengers going to the hold areas. From there, arriving passengers should be able to easily progress to baggage claim and then to the exit.

Currently, there are some conflict points. The ticket counters on the first floor are on the north and south ends. Those departing passengers on

the north end, particularly, have to pass around the baggage claim area in order to proceed to the security checkpoints. Deplaning passengers have a smoother flow in that they descend the escalators to baggage claim and exit out the center doors. Ideal terminal building flow patterns would separate the arriving and departing passengers.

TERMINAL REQUIREMENTS SUMMARY

As presented in **Exhibit 3F**, most of the considerations for the terminal building appear to be adequate to meet the demands of current enplanement levels. In fact, the terminal building was able to accommodate the peak enplanement levels experienced in 1999. Most elements appear adequate but there may be peak periods when the terminal building becomes somewhat congested.

At the current and forecast enplanement levels, significant remodeling or enlarging of the terminal building is unnecessary. Under ideal conditions, all ticket counters would be located on the same side of the ground floor, while baggage claim would be located on the opposite side along with rental agency counters. If enplanements return to historic levels or beyond, consideration might be given to expansion of the second floor over the first floor lobby area, in order to provide additional security screening and office space.

It should be noted that the primary factors contributing to terminal build-

ing space needs is the peak hour activity. Lincoln Airport has an unusually high peak hour level around the noon hour. This peak period is accentuated on Wednesdays when the 150-seat MD-83 operated by Allegiant Air arrives and departs, along with three other regional airline flights. If this peak were spread throughout the day, nearly all terminal building elements would calculate as adequate through the long term planning period.

GROUND ACCESS REQUIREMENTS

Access system facility requirements, based upon demand/capacity relationships, were developed for the system components of access roadway, terminal curb frontage, and vehicle parking. Requirements for each component are presented in the following subsection.

TERMINAL ACCESS ROADWAY

The capacity of the airport access and terminal area roadways is the maximum number of vehicles that can pass over a given section of a lane or roadway during a given time period. It is normally preferred that a roadway operate below capacity to provide reasonable flow and minimize delay to the vehicles using it.

Principal access to the airport is from West Adams Road. West Adams is a four-lane divided roadway that provides terminal area circulation. This road expands at the terminal building to provide for loading and unloading of passengers. This road provides an at-

tractive entrance to the airport and should be adequate in size and function to meet long term enplanement levels.

TERMINAL CURB FRONTAGE

The curb element is the interface between the terminal building and the ground transportation system. The length of curb required for the loading and unloading of passengers and baggage is determined by the type and volume of ground vehicles anticipated in the peak period on the design day.

A typical problem for terminal curb capacity is the length of dwell time for vehicles utilizing the curb. At airports where the curb front has not been strictly patrolled, vehicles have been known to be parked at the curb while the driver and/or riders are inside the terminal checking in, greeting arriving passengers, or awaiting baggage pick-up. Since most curbs are not designed for vehicles to remain curbside for more than two to three minutes, capacity problems can ensue. Since the events of September 11, 2001, most airports police the curb front much more strictly for security reasons. This alone has reduced the curb front capacity problems at most airports.

At LNK, the terminal roadway provides two lanes for loading and unloading of passengers and two lanes for automobile flow. The outside lane (west) is the commercial lane used by taxis, charter buses, and shuttle buses. The curb frontage totals 400 feet in length. Two factors contribute to potential congestion at the terminal

curb. First, both ends of the terminal curb are needed for unloading of passengers as the ticket counters are on each end of the terminal building. Passenger pick-up typically occurs in the center of the terminal curb. This leads to an inefficient crossing pattern of vehicles. Second, the peak period at the airport, when nearly one-third of the daily operations occur, can lead to terminal curb congestion. While less than ideal, the existing curb layout and function should adequately accommodate long term passenger levels if peaks are spread more evenly throughout the day.

VEHICLE PARKING

Vehicle parking in the airline passenger terminal area of the airport includes those spaces utilized by passengers, visitors, and employees of the airline terminal facilities. Parking spaces are classified as public, employee, and rental car.

As discussed in Chapter One – Inventory, the parking garage has a total of 491 spaces, with 124 leased by the rental car agencies. The rental car agencies also lease 60 spaces to the immediate north of the terminal building and 51 spaces to the immediate south of the terminal building. The surface lot north of the parking garage has 189 spaces and is the intermediate term lot. The large surface lot to the south of the parking garage has 537 spaces for long term public parking. South of the long term parking lot is 87 spaces for employees. An additional 54 employee spaces are available in the basement of the terminal

building. **Exhibit 3F** presents parking requirements needed to meet long term demand levels.

GENERAL AVIATION FACILITIES

General aviation (GA) facilities are those necessary for handling general aviation aircraft, passengers, and cargo while on the ground. This section is devoted to identifying future GA facility needs during the planning period for the following types of facilities normally associated with general aviation terminal areas:

- Hangars
- Aircraft Parking Apron
- General Aviation Terminal Services
- Support Facilities

HANGARS

Utilization of hangar space varies as a function of local climate, security, and owner preferences. The trend in general aviation aircraft, whether single or multi-engine, is toward more sophisticated aircraft (and consequently, more expensive aircraft); therefore, many aircraft owners prefer enclosed hangar space to outside tie-downs.

The demand for aircraft storage hangars is dependent upon the number and type of aircraft expected to be based at the airport in the future. For planning purposes, it is necessary to estimate hangar requirements based upon forecast operational activity. However, actual hangar construction

should be based upon actual demand trends and financial investment conditions.

It is common in moderate climates for a number of aircraft owners to prefer to tie-down their aircraft outside rather than rent or build an enclosed hangar. Lincoln can experience severe spring thunderstorms and significant snow and ice storms in the winter. For these reasons, planning will consider the need for hangar storage space for all forecast based aircraft.

T-hangars typically house small twin-engine or single-engine piston-powered aircraft. There is a total of 158 individual T-hangar positions and approximately 231,000 square feet of space in this category of aircraft storage currently provided at LNK. For determining future aircraft storage needs, a planning standard of 1,200 square feet per based aircraft is utilized for T-hangars.

The airport has available both connected box hangars and standalone box hangars, both of which are open-space facilities with no supporting structure interference. Currently, it is estimated that there are 19 box hangar positions. In total, these hangars provide 113,000 square feet of hangar storage space. Since a larger aircraft or multiple aircraft can be stored in a box hangar, a planning standard of 2,500 square feet per based aircraft is utilized.

There are several conventional hangars on the airfield. Conventional hangars are large open-spaced hangars typically measuring at least 80

feet by 80 feet. These hangars are often used to house airport businesses, FBOs, or corporate flight departments, or bulk storage of multiple aircraft. All of the conventional hangars immediately facing the main GA apron are considered conventional hangars.

A portion of conventional hangars often are utilized for maintenance or for office space. At a typical GA airport, maintenance area requirements can be estimated at 175 square feet per based aircraft. At Lincoln Airport, the large majority of conventional hangar space is utilized to accommodate aircraft maintenance. It is estimated that of the total of 245,000 square feet of conventional hangar space available, 218,300 square feet is utilized for maintenance purposes. The remain-

ing conventional hangar area would be available for aircraft storage. **Table 3M** provides a summary of the aircraft storage needs through the long term planning horizon.

Overall Lincoln Airport has a nicely balanced hangar mix. As the number of based aircraft grows, particularly the number of larger business jets, the need for more box and conventional hangar space may be realized. Forecasts call for approximately 50,000 square feet of conventional hangar storage space and 24,000 square feet of box hangar space through the long term planning period. The current number of T-hangars appears to be adequate. Maintenance hangar requirements will be determined by the maintenance providers at the airport.

| TABLE 3M Aircraft Storage Hangar Requirements Lincoln Airport | | | | |
|--|----------------------------|----------------------------|--------------------------|------------------|
| | Currently Available | Future Requirements | | |
| | | Short Term | Intermediate Term | Long Term |
| Total Based | 181 | 200 | 215 | 240 |
| T-hangar Positions | 158 | 128 | 138 | 155 |
| Box Hangar Positions | 19 | 47 | 50 | 55 |
| Conventional Hangar Positions | 15 | 25 | 27 | 31 |
| Hangar Area Requirements (s.f.) | | | | |
| T-hangar Area | 226,000 | 153,000 | 165,000 | 185,600 |
| Box Hangar Area | 113,000 | 118,300 | 125,500 | 136,800 |
| Conventional Hangar Area | 26,700 | 63,000 | 68,300 | 76,500 |
| Maintenance Area | 218,300 | 35,000 | 37,625 | 42,000 |
| Total Hangar Storage Area (s.f.)* | 584,000 | 369,300 | 396,400 | 440,900 |
| *Total rounded to nearest 1,000 | | | | |

AIRCRAFT PARKING APRON

FAA Advisory Circular 150/5300-13, *Airport Design*, Change 10, suggests a methodology by which transient apron

requirements can be determined from knowledge of busy-day operations. At Lincoln Airport, the number of itinerant spaces required was determined to be approximately 13 percent of the

busy-day itinerant operations. A planning criterion of 800 square yards per aircraft was applied to determine future transient apron requirements for single and multi-engine aircraft. For business jets (which can be much larger), a planning criterion of 1,600 square yards per aircraft position was used. For planning purposes, 85 percent of these spaces are assumed to be utilized by non-jet aircraft, which is in line with national trends. Locally based tie-downs typically will be utilized by smaller single engine aircraft; thus, a planning standard of 650 square yards per position is utilized.

Apron parking requirements are presented in **Table 3N**. Transient apron parking needs are divided into busi-

ness jet needs and smaller single and multi-engine aircraft needs. The presence of Duncan Aviation indicates a need to accommodate many business jets on the ramp. For planning purposes, 60 percent of the transient GA apron space needs are attributable to business jets. The remaining 40 percent of apron space needs is assigned to single and multi-engine aircraft.

Since there are very few if any aircraft owners leasing tie-down space, the local spaces needed is to accommodate maintenance activity. Typically, a maintenance provider will transfer aircraft in and out of the hangar area for specific tasks, thus utilizing the apron for temporary aircraft parking.

TABLE 3N
Aircraft Parking Apron Requirements
Lincoln Airport

| | Available | Short Term | Intermediate Term | Long Term |
|--|------------------|-------------------|--------------------------|------------------|
| Single, Multi-engine Transient Aircraft Positions Apron Area (s.y.) | | 11 8,900 | 14 11,100 | 19 15,400 |
| Transient Business Jet Positions Apron Area (s.y.) | | 17 26,700 | 21 33,300 | 29 46,200 |
| Maintenance & Tie-Down Positions Apron Area (s.y.) | | 20 13,000 | 20 13,000 | 20 13,000 |
| Total Positions | ±300 | 48 | 55 | 69 |
| Total Apron Area (s.y.) | 145,800 | 48,600 | 57,400 | 74,600 |

The total apron area needed through the long term planning period is approximately 75,000 square yards. The GA apron currently provides nearly 146,000 square yards of pavement. The existing apron is adequate and should be maintained.

**GENERAL AVIATION
TERMINAL FACILITIES**

General aviation terminal facilities have several functions. Space is required for a pilots' lounge, flight planning, concessions, management, stor-

age, and various other needs. This space is not necessarily limited to a single, separate terminal building, but can include space offered by fixed base operators (FBOs) for these functions and services. Currently, GA terminal services are provided by the FBOs at the airport.

The methodology used in estimating general aviation terminal facility needs is based on the number of airport users expected to utilize general aviation facilities during the design hour. General aviation space requirements were then based upon providing 120 square feet per design hour itinerant passenger. Design hour itinerant passengers are determined by multiplying design hour itinerant operations by the number of passengers on the aircraft (multiplier). An increasing passenger count (from 1.9 to 2.2) is used to account for the likely increase in the number of passengers utilizing general aviation services.

Table 3P outlines the general aviation terminal facility space requirements for Lincoln Airport.

An additional consideration for terminal space is the anticipated emergence of a new class of aircraft. A number of aircraft manufacturers will be producing lower-cost microjets or very light jets (VLJs). The VLJs typically have a capacity of up to six passengers. A number of new companies are positioning themselves to utilize the VLJs for on-demand air taxi services. The air taxi businesses are banking on a desire by business travelers to avoid delays at major commercial service airports. Airports with appropriate general aviation terminal facilities are better positioned to meet the needs of this new class of business traveler. As presented in the table, the existing public spaces appear adequate through the long term of the master plan.

| | Available | Short Term | Intermediate Term | Long Term |
|---|------------------|-------------------|--------------------------|------------------|
| Design Hour Operations | 23 | 29 | 38 | 59 |
| Design Hour Itinerant Operations | 19 | 22 | 28 | 39 |
| Multiplier | 1.8 | 1.9 | 2 | 2.2 |
| Total Design Hour Itinerant Passengers | 34 | 42 | 56 | 85 |
| General Aviation Building Spaces (s.f.) | ±10,000 | 5100 | 6700 | 10,200 |

AIR CARGO

Air cargo is comprised of air freight and air mail. Historically, air mail and freight at Lincoln Airport has

been carried as belly freight. There are no all-cargo carriers currently providing service from Lincoln Airport. A cargo facility is located south of the terminal building, with landside ac-

cess from West Adams Street. As indicated in the previous chapter, for planning purposes, a cargo forecast has been developed for the airport. Because the cargo forecasts support those provided in the previous Master Plan, the requirements will also be the same.

To examine cargo aircraft ramp or apron needs, the space requirements of individual aircraft common in air cargo use were reviewed. The B-727-200 requires an average ramp envelope of 5,900 square yards. The DC-8 or B-757 needs 8,800 square yards,

and a B-747 requires up to 13,400 square yards of cargo ramp and circulation space. The existing apron area is located between the terminal apron and the existing air cargo building and contains approximately 6,000 square yards. This area could accommodate one B727-200 cargo aircraft. A need to park more than one large aircraft on the existing cargo apron area would encroach upon not only the terminal apron, but would infringe upon the taxiway access to Runway 35R. **Table 3Q** outlines the cargo requirements for Lincoln Municipal Airport.

| TABLE 3Q Air Cargo Facility Requirements Lincoln Airport | | | | |
|---|------------------|-------------------|--------------------------|------------------|
| | Available | Short Term | Intermediate Term | Long Term |
| Cargo Apron (s.y.) | 6,000 | 6,000 | 12,000 | 15,000 |
| Cargo Building (s.f.) | 21,300 | 9,300 | 1,400 | 24,800 |

The existing cargo building contains 21,290 square feet. Based on an industry standard of processing 800 annual pounds of air cargo per square foot of building, the present building would be adequate until late in the planning period. **Table 3Q** also outlines the building space requirements.

One factor for the airport to consider is the growth of the rail center on the west side of the airport. If this facility grows as anticipated, there may be a need for convenient access to air cargo facilities. For this reason, alternatives will consider the ultimate relocation of air cargo facilities to the west side of the airfield. But until such a time that demand dictates, the existing facility will be adequate.

SUPPORT FACILITIES

Various facilities that do not logically fall within classifications of airside or landside facilities have also been identified. These other areas provide certain functions related to the overall operation of the airport.

AUTOMOBILE PARKING

General aviation vehicular parking demands have been determined for Lincoln Airport. Space determinations were based on an evaluation of existing airport use, as well as industry standards. Terminal automobile parking spaces required to meet general aviation itinerant demands were

calculated by taking the design hour itinerant passengers and using a multiplier of 1.9, 2.0, and 2.2 for each planning period. This multiplier represents the anticipated increase in corporate operations and thus, passengers.

Currently there are approximately 60 parking spaces available for itinerant GA parking. Both Duncan Aviation and Silverhawk Aviation provide these spaces. As presented in **Table 3R**, there is not an anticipated need for more itinerant GA parking in the short term, but by the long term as many as 106 spaces may be needed.

The parking requirements of based aircraft owners should also be considered. Although some owners prefer to

park their vehicles in their hangars, safety can be compromised when automobile and aircraft movements are intermixed. For this reason, separate parking requirements which consider a parking space for one-half of the based aircraft at the airport were applied to general aviation automobile parking space requirements.

The need for parking spaces for employees of Duncan Aviation was also considered. Currently, there are approximately 800 spaces available for employee parking. Because Duncan Aviation runs more than one shift, the current level of parking is adequate. If projected growth in employment is realized, then the existing parking lots may become constrained.

| | Future Requirements | | | |
|------------------------------------|----------------------------|-------------------|--------------------------|------------------|
| | Available | Short Term | Intermediate Term | Long Term |
| Design Hour Itinerant Passengers | 23 | 29 | 38 | 59 |
| GA Itinerant Spaces | 60 | 52 | 68 | 106 |
| GA Based Spaces | | 100 | 108 | 120 |
| Total GA Parking Area (s.f.) | 24,000 | 60,600 | 70,200 | 90,500 |
| Total Employee Parking | 800 | 900 | 1,000 | 1,200 |
| Total Employee Parking Area (s.f.) | 332,000 | 360,000 | 400,000 | 480,000 |
| Total Parking Spaces | 860 | 1,052 | 1,176 | 1,426 |
| Total Parking Area (s.f.) | 356,000 | 420,600 | 470,200 | 570,500 |

The number of parking spaces appears to be adequate, but the location of those lots may not be convenient or efficient. While this analysis presents an overall number to plan for, it does not locate those facilities. For exam-

ple, the GA hangar facilities at Lincoln Airport are spread over a wide area. Several smaller lots may be appropriate in the future. All future facility planning will consider parking requirements.

FUEL STORAGE

There is a dedicated fuel farm area located to the southeast of the general aviation apron. Both Duncan Aviation and Silverhawk Aviation maintain fuel storage tanks in this location. The fuel farm has space for expansion. Expansion needs will be determined by the individual FBOs based on their availabilities to meet demand.

AIRCRAFT RESCUE AND FIREFIGHTING (ARFF)

Part 139 airports are required to provide aircraft rescue and fire fighting (ARFF) services during air carrier operations. Each certificated airport maintains equipment and personnel based on an ARFF index established according to the length of aircraft and scheduled daily flight frequency. There are five indices, A through E, with A applicable to the smallest aircraft and E the largest (based on wingspan). Lincoln Airport falls within ARFF index B. As such, Lincoln Airport is required to maintain a fleet of equipment and properly trained personnel consistent with this standard.

The Lincoln Airport ARFF facility is operated by the Nebraska Air National Guard. Twelve personnel per shift are designated as ARFF personnel, with at least eight firefighters on duty at the fire station during air carrier operations. ARFF personnel are equipped with aluminized protective clothing and self-contained breathing apparatus meeting National Fire Protection Association (NFPA) standards.

The ARFF personnel receive initial and recurrent training (at least every 12 months) in the following areas:

- a. Airport familiarization, including signs, marking, & lighting.
- b. Aircraft familiarization.
- c. Rescue and firefighting personnel safety
- d. Emergency communications systems on the airport, including fire alarms.
- e. Use of fire hoses, nozzles, turrets, and other appliances required.
- f. Application of the types of extinguishing agents required for Part 139 Certification.
- g. Emergency aircraft evacuation assistance.
- h. Firefighting operations.
- i. Using firefighting equipment for aircraft rescue and firefighting.
- j. Aircraft cargo hazards and materials.
- k. Familiarization with the Airport Emergency Plan.

All firefighters participate in a live fire drill at least once a year and they are trained in basic medical care. Lincoln Airport has four emergency access roads. They are the North Service Road, the Terminal Service Road, the Tower Service Road, and the South Service Road.

The ARFF facility encompasses approximately 44,000 square feet and houses for ARFF vehicles, including two Teledyne-Continental P-23 fire trucks. Each truck has a capacity for 3,300 gallons of water, 500 gallons of fire retardant foam, and 500 pounds of

Dry Chemical. The third vehicle is an Oshkosh P-19 High Reach with a capacity for 1,500 gallons of water, 310 gallons of fire retardant foam, and 450 pounds of Dry Chemical. The fourth truck is an Oshkosh P-4 Airport Fire Truck with a capacity of 1,500 gallons of water and 180 gallons of fire retardant foam.

SNOW AND ICE REMOVAL

The Lincoln area receives an average of 27.7 inches of snow annually. Generally this occurs during the months from November through March. The heaviest snow typically falls in January, February, and March. As a result, an evaluation of the snow removal equipment and storage is in order.

The FAA Advisory Circular 5200-30A, *Airport Winter Safety and Operations*, provides general guidance for snow clearance for commercial service airports. According to the Circular, "commercial service airports should have sufficient equipment to clear one inch of snow weighing up to 25 pounds per cubic foot from the primary instrument runway, one or two principal taxiways to the ramp area, emergency or firefighters access roads, and sufficient ramp area to accommodate anticipated aircraft operations." The time that one inch of snow should be cleared is based on the number of annual operations for the airport. Lincoln Airport is in the highest category of over 40,000 annual operations, so the clearance time requirement is one-half hour.

The minimum area required for LNK would include Runway 18-36, Taxiways D, K, and J, the terminal ramp, ILS critical area and ILS access roads, ARFF compound, and access road. Adherence to the snow removal plan constitutes approximately 5.1 million square feet of pavement to be cleared. Assuming a density of 25 pounds per cubic foot, this translates to a requirement to clear over 5,300 tons per hour.

The following is a list of the snow removal equipment currently available at the airport:

- a. 4 – 4x4 trucks with 19' reversible blades
- b. 4 – 4x4 trucks with rollover blades
- c. 3 – Runway brooms
- d. 3 – Rotary snow blowers (rated at 3,000, 3,500, and 3,500 tons per hour)
- e. 3 – Front end loaders
- f. 1 – Motor grader
- g. 1 – Skid loader
- h. 1 – Runway Anti De-icing machine
- i. 1. – K.J. Law friction tester

Snow removal equipment is stored in the airport's maintenance facility. This building should be adequate for the parking and maintenance of the existing maintenance and snow removal equipment. Space is available for future expansion if needed.

WASH RACK

The airport does not currently provide a designated aircraft wash rack. Of-

ten, airports with active general aviation will provide a designated facility for aircraft cleaning purposes. The presence of a designated area allow for the control of discharged cleaning fluids. An aircraft wash rack is also an attractive amenity for based aircraft owners.

FENCING

The entirety of Lincoln Airport is enclosed by chainlink fencing. Fencing at the airport meets Title 14 CFR Part 107 and Part 1542 requirements and will prevent inadvertent entry onto airport property by persons or vehicles. Signs restricting access are posted on all gates and at regular intervals around the perimeter. The airport has established procedures in the Airport Security Program for controlling access onto the air operations area through perimeter gates.

AIRPORT MAINTENANCE BUILDING

The primary airport maintenance facility is located adjacent to the west ramp and is composed of two buildings. The larger building encompasses approximately 44,000 square feet and is used for primary equipment storage. The second building is approximately 23,500 square feet and is used for equipment and sand storage. A maintenance vehicle fuel farm is located in this area, containing one 4,000-gallon (aboveground) gasoline tank, two 4,000-gallon (aboveground) diesel

tanks, and one 6,000-gallon (aboveground) Glycol tank. These facilities should be adequate through the long term planning period.

WILDLIFE HAZARD MANAGEMENT

Wildlife is abundant in this area of the Great Plains. The airport lies on the edge of the Central flyway, the migratory path used by many species of waterfowl. The presence of water, vegetation, agricultural land, and structures in the vicinity of the airport serve as attractants for wildlife.

In September 2000, the U.S. Department of Agriculture Animal and Plant Inspection Service – Wildlife Services completed a Wildlife Hazard Assessment. Many of the recommendations of the assessment have been completed. Active farming of airport property has been limited to areas considered a safe distance from the airfield. A capture and release program for birds of prey has been undertaken. A capture and release program for the removal of starlings has also been undertaken. A grass height management program has also been ongoing. The airport should maintain these procedures to insure the safe operation of aircraft in the airport environment.

The airport employs a full-time wildlife biologist from the USDA on a contract basis. The wildlife biologist manages the Wildlife Hazard Management Program for the airport.

UTILITIES

Access to appropriate utilities for future development is available to the east and west sides of the airport.

SUMMARY

The intent of this chapter has been to outline the facilities required to meet potential aviation demands projected for Lincoln Airport for the planning

horizon. A summary of the airside and landside requirements is presented on **Exhibits 3G** and **3H**.

Following the facility requirements determination, the next step is to determine a direction of development which best meets these projected needs through a series of airport development alternatives. The remainder of the master plan will be devoted to outlining this direction, its schedule, and its cost.



AVAILABLE

| | | | |
|--|--|---|--|
| <p>Runway 18-36 ARC D-IV 12,901' x 200' Asphalt/Concrete-grooved 200,000# DWL 400,000# DTWL</p> <p>Runway 14-32 ARC D-III 8,649' x 150' Asphalt Concrete-grooved 170,000# DWI 280,000# DTWL</p> <p>Runway 17-35 ARC D-II 5,400' x 100' Asphalt/concrete-friction coat 49,000# SWL 60,000# DWL</p> | <p>Runway 18-36 75' Wide Full length parallel Five east exits; 4 west exits</p> <p>Runway 14-32 75' Wide Full length parallel Eight Exits</p> <p>Runway 17-35 50'-75' Wide Full length parallel Five east exits; 4 west exits</p> | <p>ATCT, VOR, LLWAS, ATIS RCO, ASOS</p> <p>Runway 18-36 ILS; HI-VOR/DME; RNAV (GPS) VOR (18) NDB (36)</p> <p>Runway 14-32 RNAV (GPS) (14)</p> <p>Runway 17-35 VOR (17) GPS (17)</p> | <p>Rotating beacon Four lighted windcones HITL (same throughout)</p> <p>Runway 18-36 Precision marking MALSR PAPI-4L HIRL</p> <p>Runway 14-32 Nonprecision marking REIL (14) VASI-4L MIRL</p> <p>Runway 17-35 Nonprecision marking REIL (17) PAPI-4L ODALS (35) HIRL</p> |
|--|--|---|--|

SHORT TERM

| | | | |
|---|--|--|---|
| <p>Runway 18-36 12,901' x 150'</p> <p>Runway 14-32 SAME</p> <p>Runway 17-35 SAME</p> | <p>Runway 18-36 Additional high speed exit</p> <p>Runway 14-32 SAME</p> <p>Runway 17-35 Uniform 50' width</p> | <p>Runway 18-36 SAME</p> <p>Runway 14-32 CAT I GPS</p> <p>Runway 17-35 GPS (35)</p> | <p>Runway 18-36 SAME</p> <p>Runway 14-32 Precision markings MALSR PAPI-4L</p> <p>Runway 17-35 SAME</p> |
|---|--|--|---|

LONG TERM

| | | | |
|---|---|---|---|
| <p>Runway 18-36 SAME</p> <p>Runway 14-32 SAME</p> <p>Runway 17-35 SAME</p> | <p>Runway 18-36 SAME</p> <p>Runway 14-32 SAME</p> <p>Runway 17-35 SAME</p> | <p>Runway 18-36 SAME</p> <p>Runway 14-32 SAME</p> <p>Runway 17-35 SAME</p> | <p>Runway 18-36 SAME</p> <p>Runway 14-32 SAME</p> <p>Runway 17-35 SAME</p> |
|---|---|---|---|

KEY

PAPI - Precision Approach Path Indicator
GPS - Global Positioning System
VOR/DME - Very High Frequency Omni-directional Range/Distance Measuring Equipment
VASI - Visual Approach Slope Indicator
REIL - Runway End Identification Lights
MALSR - Medium Intensity Approach Lighting System with Runway Alignment Indicator Lights
ODALS - Omni-Directional Approach Lighting System

HIRL/MIRL - High/Medium Intensity Runway Lighting
HITL/MITL - High/Medium Intensity Taxiway Lighting
NDB - Non-Directional Beacon
ATCT - Airport Traffic Control Tower
LLWAS - Low Level Windshear Alert System
ATIS - Automatic Terminal Information Services
ASOS - Automated Surface Observation System
RCO - Remote Communications Outlet

Aircraft Storage



| | Available | Short Term Need | Intermediate Term Need | Long Term Need |
|---------------------------------|----------------|-----------------|------------------------|----------------|
| T-hangar Positions | 158 | 128 | 138 | 155 |
| Box Hangar Positions | 19 | 47 | 50 | 55 |
| Conventional Hangar Positions | 15 | 25 | 27 | 31 |
| T-hangar Area (s.f.) | 226,000 | 153,000 | 165,000 | 185,600 |
| Box Hangar Area (s.f.) | 113,000 | 118,300 | 125,500 | 136,800 |
| Conventional Hangar Area (s.f.) | 26,700 | 63,000 | 68,300 | 76,500 |
| Maintenance Area (s.f.) | 218,300 | 35,000 | 37,625 | 42,000 |
| Total Hangar Area (s.f.) | 584,000 | 369,300 | 396,400 | 440,900 |

Aircraft Apron



| | Available | Short Term Need | Intermediate Term Need | Long Term Need |
|---|----------------|-----------------|------------------------|----------------|
| Single, Multi-engine Transient Aircraft Positions | | 11 | 14 | 19 |
| Apron Area (s.y.) | | 8,900 | 11,100 | 15,400 |
| Transient Business Jet Positions | | 17 | 21 | 29 |
| Apron Area (s.y.) | | 26,700 | 33,300 | 46,200 |
| Locally-Based Aircraft Positions | | 20 | 20 | 20 |
| Apron Area (s.y.) | | 13,000 | 13,000 | 13,000 |
| Total Positions | ±300 | 48 | 55 | 69 |
| Total Apron Area (s.y.) | 145,800 | 48,600 | 57,400 | 74,600 |

General Aviation Services



| | Available | Short Term Need | Intermediate Term Need | Long Term Need |
|----------------------------------|----------------|-----------------|------------------------|----------------|
| GA Building Space (s.f.) | ±10,000 | 5,100 | 6,700 | 10,200 |
| GA Terminal Parking Spaces | 60 | 52 | 68 | 106 |
| GA Terminal Parking Area (s.f.) | 24,000 | 60,600 | 70,200 | 90,500 |
| Employee Parking Spaces | 800 | 900 | 1,000 | 1,200 |
| Employee Parking Area (s.f.) | 332,000 | 360,000 | 400,000 | 480,000 |
| Total Parking Spaces | 860 | 1,052 | 1,176 | 1,426 |
| Total Parking Area (s.f.) | 356,000 | 420,600 | 470,200 | 570,500 |

Lincoln Airport

ALTERNATIVES

Prior to determining a recommended plan, it is beneficial to consider several development alternatives and assess the advantages and constraints of each. In this chapter, a series of development scenarios are considered for the airport. The overall goal is to satisfy the projected demand through the long term planning period and to identify the highest and best uses for airport property. The alternatives take into consideration existing physical constraints and appropriate federal design standards, where appropriate. The alternatives analysis is an important step in the planning process since it becomes the underlying rationale for any final master plan recommendations.

Any development proposed for a master plan is evolved from an analysis of projected needs for a set period of time.

Though the needs were determined by the best methodology available, it cannot be assumed that future events will not change these needs. The master planning process attempts to develop a viable concept for meeting the needs generated by projected demands through the planning period.

The possible combination of alternatives can be endless, so some professional judgment along with a thorough understanding of the various federal airport regulations must be used to identify the alternatives which have the greatest potential for implementa-



tion. The evaluation of alternatives is a process of deciding which options are most compatible with the goals and objectives of the Lincoln Airport Authority. After the evaluation process, a selected airport concept can be transformed into a realistic development plan.

The development alternatives for the Lincoln Airport can be categorized into two functional areas: The airside (runway and taxiway) system and landside (terminal area, general aviation area, etc.) facilities. Within each of these areas, specific development is required or desired. In addition, the utilization of the remaining airport property to provide revenue support for the airport and to benefit economic development and the well-being of the Lincoln area must be considered.

The focus of this chapter is the identification of several development alternatives that can meet existing and/or future demand milestones. Often, at airports where the overall location or role of the airport is in question, non-development alternatives will be considered. Non-development alternatives include “no-build,” transfer of services to another airport, and construction of a replacement airport. None of these alternatives meet the overall goals of the Lincoln Airport Authority and will not be considered.

AIRPORT DEVELOPMENT OBJECTIVES

It is the overall objective of this effort to produce a balanced airside and landside complex to serve forecast

aviation demands. However, before defining and evaluating specific alternatives, airport development objectives should be considered. The Lincoln Airport Authority provides the overall guidance for the operation and development of Lincoln Airport. It is of primary concern that the airport is marketed, developed, and operated for the betterment of its users. With this in mind, the following development objectives have been defined for this planning effort:

- C Maintain an attractive, efficient, and safe aviation facility in accordance with federal safety regulations.
- C Develop facilities necessary to accommodate expanded scheduled airline service.
- C Develop facilities to efficiently serve general aviation users and encourage increased use of the airport, including increased business and corporate use of the airport.
- C Provide sufficient airside and landside capacity through additional facility improvements which will meet the long term planning horizon level of demand of the area.
- C Identify any future land acquisition needs.
- C Ensure that any recommended future development is environmentally compatible.

The remainder of this chapter will describe various development alterna-

tives for the airside and landside facilities. Within each of these areas, specific facilities are required or desired. Although each area is treated separately, planning must integrate the individual requirements so that they complement one another. **Exhibit 4A** presents both airside and landside planning issues that will be specifically addressed.

AIRFIELD ALTERNATIVES

Airfield facilities are, by nature, the focal point of the airport complex. Because of their primary role and the fact that they physically dominate airport land use, airfield facility needs are often the most critical factor in the determination of viable airport development alternatives. In particular, the runway system requires the greatest commitment of land area and often imparts the greatest influence on the identification and development of other airport facilities. Furthermore, aircraft operations dictate the Federal Aviation Administration (FAA) design criteria that must be considered when looking at airfield improvements. These design standards can often have a significant impact on the viability of various alternatives designed to meet airfield needs.

The issues related to airfield development are presented as they relate to each runway and the adjacent taxiway system. After each airfield issue is identified and alternatives are presented, the selected alternatives, in combination, will make up the recom-

mended concept to be presented in Chapter Five – Airport Plans.

AIRFIELD DESIGN STANDARDS

The design of airfield facilities includes not only the pavement areas, but also the surrounding areas designed to protect safe operation of aircraft at the airport, as previously presented on Exhibit 3E. These areas include the runway safety area (RSA), the object free area (OFA), the obstacle free zone (OFZ), the precision obstacle free zone (POFZ), and the runway protection zone (RPZ). The RSA and OFA dimensions are the same for all three runways. The POFZ only applies to runway ends with vertically guided precision approaches, such as Runways 18 and 36. The RPZ applies to each runway end and is dimensioned based on the critical aircraft utilizing that runway and the type of instrument approaches available.

The RSA should be 500 feet wide and extend 1,000 feet beyond the far end of the runway and 600 feet prior to the landing threshold. The OFA is 800 feet wide and extends beyond the runway ends in the same manner as the RSA. When the localizer antenna south of the Runway 36 threshold is relocated in 2007, it will no longer be a penetration to the RSA. All other RSAs meet FAA requirements for length and width.

There are currently four OFA penetrations, all of which have been addressed by the FAA and the Lincoln Airport Authority. The first is the

electrical vault associated with the localizer south of Runway 36. The electrical vault will be moved in 2007 when the localizer is moved and will no longer be an OFA penetration. The southeast corner of the OFA for Runway 14 is penetrated by the airport service road. The current Airport Layout Plan, as approved by the FAA, shows the service road to be relocated outside the OFA, as depicted on **Exhibit 4B**.

The northeast corner of the OFA for Runway 17 is penetrated by the airport service road. The service road cannot be easily relocated outside of the OFA as this would require moving the perimeter fence and extending the service road into the right-of-way for North Park Road. As a result, the FAA granted a modification to standard in 1999 in order to maintain the current condition.

The last OFA penetration is the service road which extends from the terminal area apron around the south end of Runway 35. This OFA penetration has been addressed with the FAA and a Modification to Standards has been issued. No further action is required. **Exhibit 4B** shows the OFA penetrations and the proposed re-routed service roads.

The POFZ is an area 800 feet wide and 200 feet long, located immediately off each runway end and served by an instrument landing system (ILS). The POFZs serving Runway 18-36 are clear of obstructions. The Runway 18 POFZ is protected by an ILS hold line on Taxiway D and a runway hold line on Taxiway B. The Runway 36 POFZ

is protected by an ILS hold line on Taxiway G.

The RPZs are trapezoidal areas beginning 200 feet from each runway end and extending in accordance to the types of approved instrument approaches for the runway. The RPZs should be positively controlled by the airport and clear of incompatible land uses. All existing RPZs are either fully owned by the airport or are controlled through avigation easements. Thus, all RPZs meet FAA standards. If any runways are changed in length or with an improved instrument approach procedure, the RPZs will change accordingly. The changes could require additional property acquisition in the future.

RUNWAY 18-36

The FAA provides federal grant-in-aid assistance to airports across the country for capital projects. Construction and maintenance of the runways and taxiways is currently eligible for 95 percent funding in grants from the FAA. The FAA will typically make grant funds available for those portions of each runway that are necessary to meet FAA design standards. As demonstrated in Chapter Three – Facility Requirements, Runway 18-36 exceeds the design standards in both length and width.

The FAA has requested that airports provide critical analysis of runway dimensional standards in order to justify maintaining existing dimensional standards for runways that exceed standard. The baseline dimensional

AIRSIDE PLANNING ISSUES

→ Runway 18-36

Length and width analysis

Long term capacity improvements

Analysis of the complex intersection with Runway 14-32

Adequacy of instrument approaches

Application of FAA design standards including the departure surface

→ Runway 17-35

Alternatives to reduce Runway 35/Taxiway A confusion

Adequacy of instrument approaches

→ Runway 14-32

Potential to relocate Runway 14-32 landing thresholds to pavement ends

Analysis of Taxiway N confusion

Adequacy of instrument approaches

Alternatives for Taxiway E and D intersection

LANDSIDE PLANNING ISSUES

→ Airport terminal building review

→ General aviation review

→ Land use and strategic land acquisition

→ Air cargo analysis

→ Airport support facilities

04/18/2014 14:07

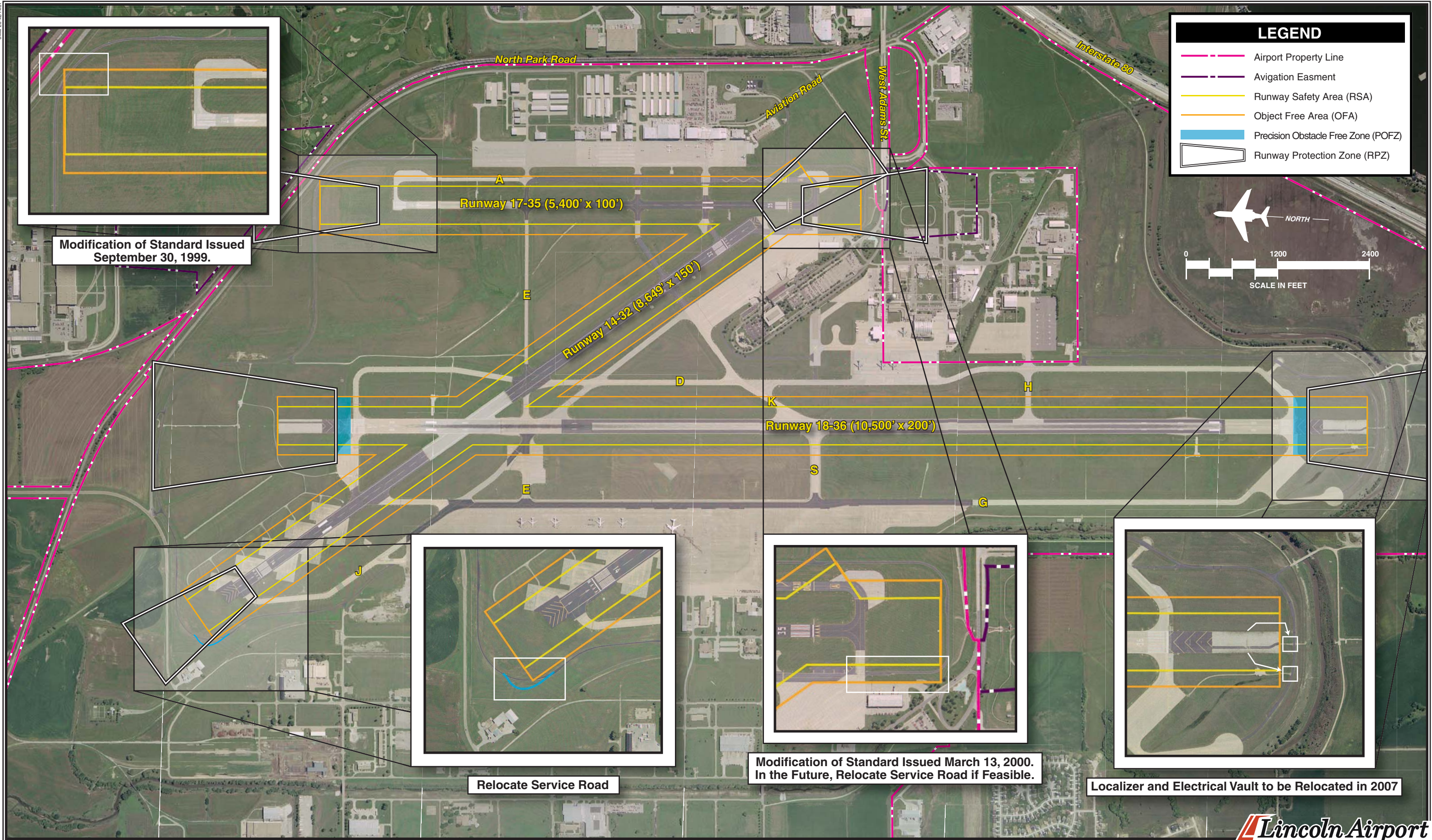

LEGEND

- Airport Property Line
- Avigation Easment
- Runway Safety Area (RSA)
- Object Free Area (OFA)
- Precision Obstacle Free Zone (POFZ)
- Runway Protection Zone (RPZ)

NORTH

0 1200 2400

SCALE IN FEET

Modification of Standard Issued September 30, 1999.

Relocate Service Road

Modification of Standard Issued March 13, 2000. In the Future, Relocate Service Road if Feasible.

Localizer and Electrical Vault to be Relocated in 2007

standards that apply to runways are based on the critical aircraft or family of aircraft intending to perform in excess of 500 annual operations. Analysis in Chapter Three – Facility Requirements indicated that Runway 18-36 should be designed to accommodate aircraft in airport reference code (ARC) D-IV. This ARC will allow the airport to continue to accommodate nearly all commercial aircraft.

Runway Width

The FAA standard for runway width for a critical aircraft in ARC D-IV is 150 feet. Runway 18-36 is currently 200 feet wide. Engineering analysis was conducted to compare the cost of reducing the runway width to 150 feet versus the cost of maintaining the current width over the 20 year planning term of this master plan. Two options for maintaining the current runway width of 200 feet and three options for reducing the runway width to 150 feet are presented on **Exhibit 4C**.

Following guidance provided in FAA AC 150/5320-6D, *Airport Pavement Design and Evaluation*, Appendix 1, several pavement rehabilitation alternatives were considered. A 30-year pavement life for concrete was used and a 20-year pavement life for asphalt was used. According to the FAA, if the difference in cost between any two alternatives is ten percent or less, it is normally assumed to be insignificant and the two alternatives can be assumed to cost the same. The baseline pavement cross-section for concrete and asphalt used in this analysis was obtained from the “Report on Runway 17R-35L [now 18-36] Pavement” study completed in 1989 by HWS.

The 1989 pavement study recommended reconstructing the runway at a 200-foot width, with concrete. The recommended pavement cross-section consisted of 15 inches of concrete in the inner 100-foot keel section, transitioning to 11 inches from 50 feet to 75 feet of centerline, and 11 inches of concrete from 75 feet to 100 feet of centerline, all on six inches of stabilized base.

In 1991, a runway rehabilitation project was undertaken in which the inner 100-foot keel section of the runway was reconstructed with 15 inches of concrete. The outer 50 feet of pavement on each side of the runway was milled and overlaid with two inches asphalt on top of the existing seven to 11 inches of asphalt. This alternative to the recommended runway cross-section was adopted in order to keep the runway down-time to a minimum and to reduce overall project cost.

A 2002 Pavement Condition Index (PCI) Study of the outer 50-foot asphalt sections showed PCI ratings of 29, 32, and 26. These ratings are considered “poor” and indicate that the outer sections are deteriorating. The underlying base of the asphalt sections range in age from 36 to 53 years old and have outlived their useful life. Therefore, all pavement alternatives examined reconstruction of the runway’s outer asphalt pavement, with the exception of Option E, on **Exhibit 4C**, in which the existing outer asphalt section from 75 feet to 100 feet from the centerline was considered for milling and overlay. These 25-foot

outer sections were then planned for use as shoulders only and not active runway pavement.

Cost estimates for both new construction and rehabilitating the runway pavement were developed. Loss of revenue from landing fees during runway down-times for construction was also estimated for all of the con-

struction alternatives. It was assumed that any asphalt pavement would receive a sealer/rejuvenator application every five years. The maintenance costs for maintaining the 100-foot keel section of the runway was not considered in this analysis as the costs would be the same for all alternatives. The alternatives were then analyzed and are presented in **Table 4A**.

| TABLE 4A | | |
|--|--|--------------------------|
| Runway 18-36 Pavement Alternative Analysis | | |
| Lincoln Airport | | |
| Option | Description | Cost (\$millions) |
| Maintain Runway at 200-foot Width | | |
| Option A | Replace pavement 50' to 75' from centerline with 15" PCC to 11" PCC. | 11.69 |
| | Replace pavement 75' to 100' from centerline with 11" PCC. | |
| Option B | Replace pavement 50' to 75' from centerline with 14.5" to 10.5" ACC. | 13.15 |
| | Replace pavement 75' to 100' from centerline with 10.5" ACC. | |
| Reduce Runway to 150-foot Width | | |
| Option C | Replace pavement 50' to 75' from centerline with 15" PCC to 11" PCC. | 11.64 |
| | Replace pavement 75' to 100' from centerline with 8" ACC shoulder. | |
| | Move HIRL into 85' from centerline. | |
| | Relocate PAPIs. | |
| Option D | Replace pavement 50' to 75' from centerline with 15" PCC to 11" PCC. | 12.39 |
| | Replace pavement 75' to 100' from centerline with 8" shoulder. | |
| | Move HIRL into 85' from centerline. | |
| | Relocate PAPIs. | |
| Option E | Replace pavement 50' to 75' from centerline with 15" PCC to 11" PCC. | 10.80 |
| | Mill existing pavement 75' to 100' from centerline and overlay with ACC. | |
| | Move HIRL into 85' from centerline. | |
| | Relocate PAPIs. | |
| PCC: Portland Cement Concrete ACC: Asphalt Cement Concrete HIRL: High Intensity Runway Lights PAPI: Precision Approach Path Indicator | | |
| <i>Source: HWS Analysis</i> | | |

The most cost-effective alternative is Option E, which proposes reducing the runway to a width of 150 feet and utilizing the remaining pavement as a shoulder. The cost for Option E is approximately \$10.80 million. There is a cost savings advantage associated

with leaving in place the outer 75 feet to 100 feet pavement section and utilizing it as a shoulder. The disadvantage is that the outer section's underlying base below the overlay will continue to deteriorate and degrade.

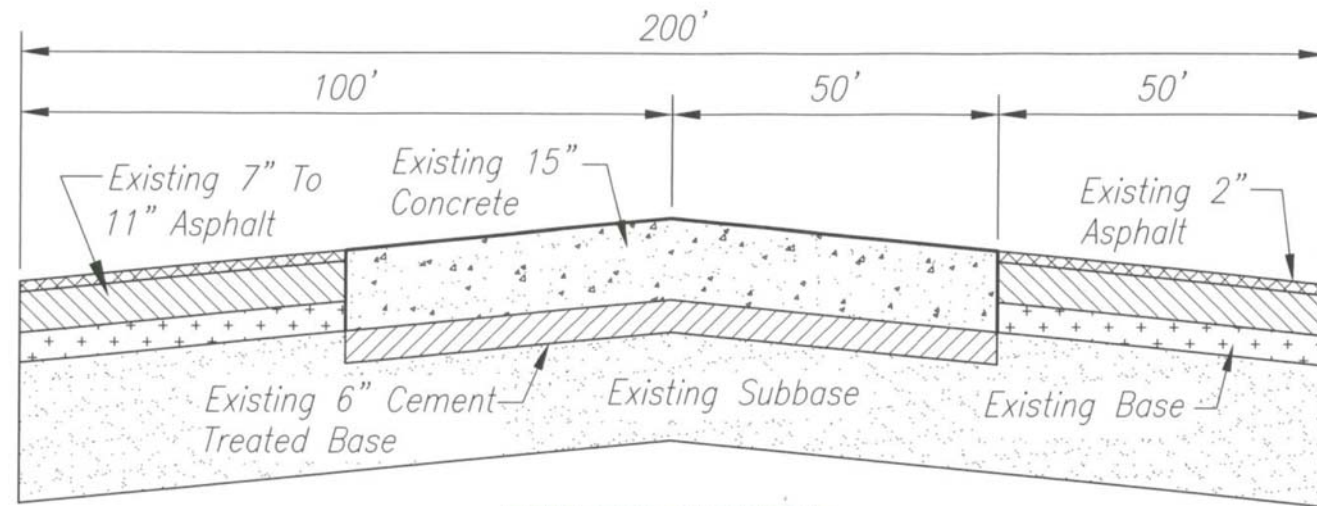

EXISTING PAVEMENT

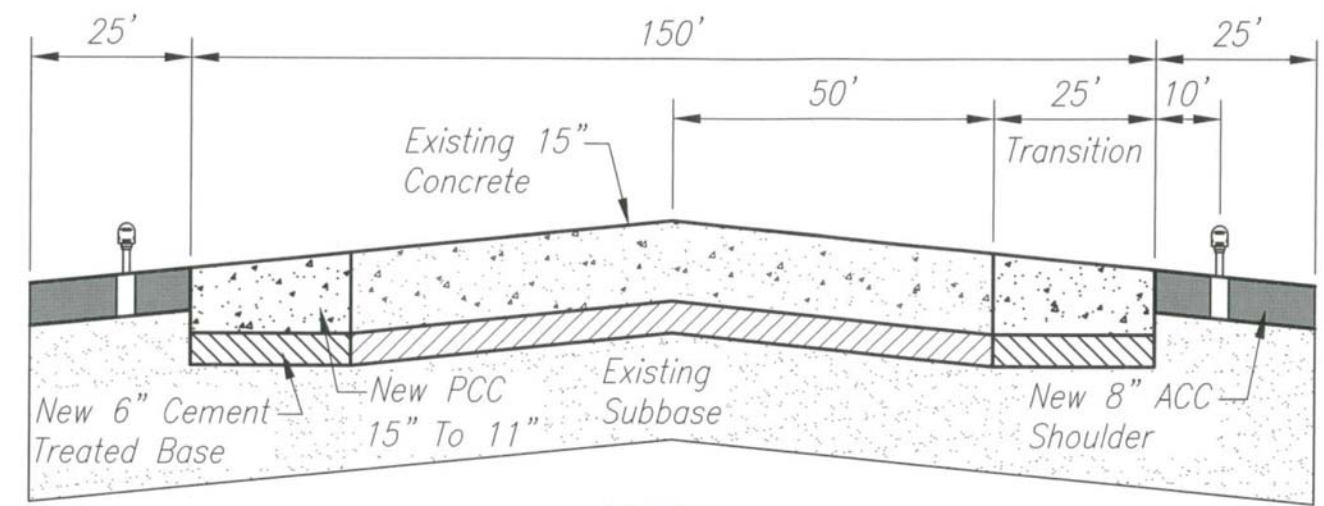

OPTION C

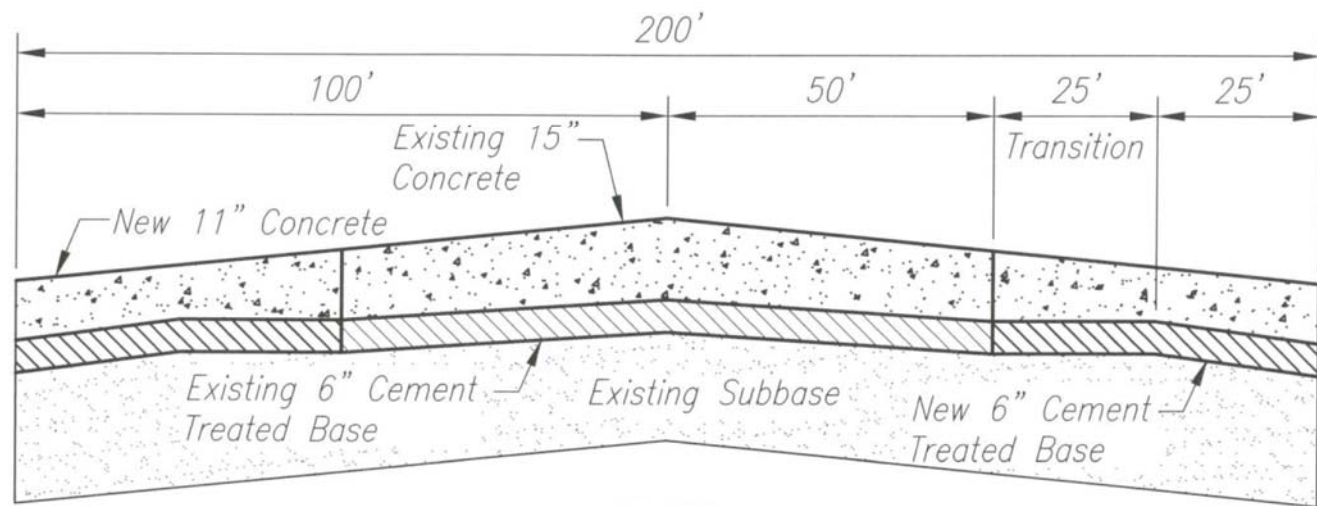

OPTION A

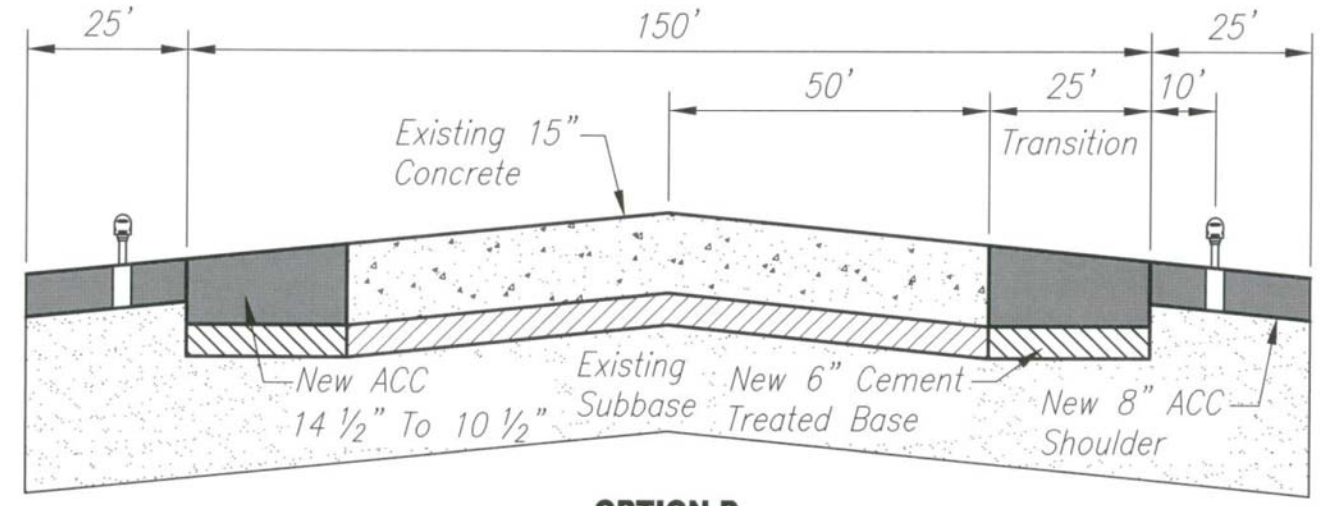

OPTION D

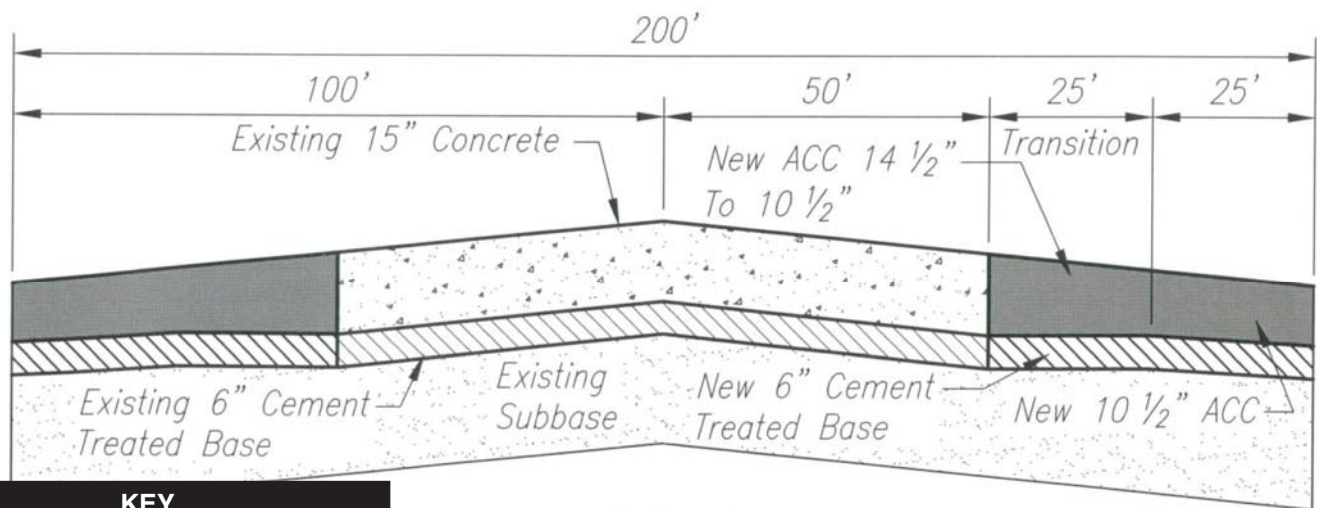

OPTION B

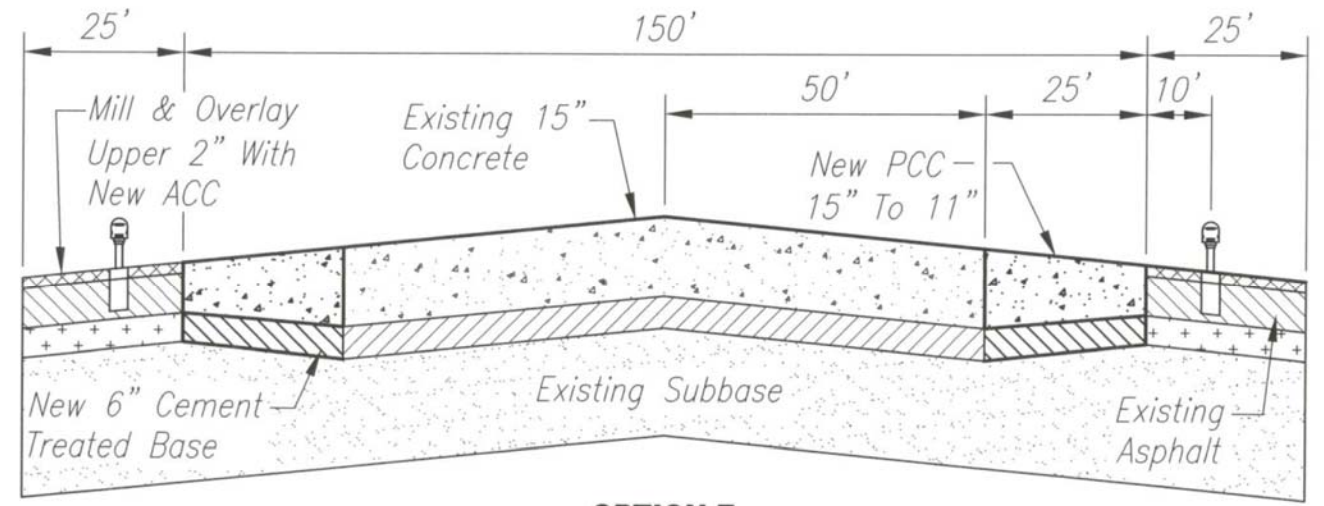

OPTION E

KEY
 ACC: Asphalt Cement Concrete
 PCC: Portland Cement Concrete

The next most cost-effective alternative is Option C, which proposes reducing the width to 150 feet and constructing a new 25-foot asphalt shoulder. The cost for Option C is \$11.64 million. The next most cost-effective alternative is Option A, which proposes to maintain the runway at a width of 200 feet with concrete. The cost of Option A is \$11.69 million, nearly identical to Option C.

In accordance with the economic analysis, since Options A, C, and E are within 10 percent of each other, the three options can be considered equal since the difference among the three is considered insignificant. The Lincoln Airport Authority could choose either alternative based upon other factors not associated with pavement design and construction.

A decision on which option will best serve the Lincoln Airport Authority and the FAA will need to be finalized by the two parties prior to the issuance of grants for Runway 18-36 rehabilitation or reconstruction.

Runway Length

Runway 18-36 is 12,901 feet long by 200 feet wide. This is the primary runway utilized by commercial service aircraft as well as the ten military KC-135s based at the airport. This runway provides an adequate strength rating to serve all aircraft in both the commercial and military fleets. The runway is equipped with ILS approaches to both runway ends.

The FAA fundable runway length is determined by the critical civilian air-

craft operating at the airport. As of this writing, the MD83 operated by Allegiant Air would represent the critical aircraft. As presented in Chapter Three – Facility Requirements, the MD83 would need a maximum runway length of 10,500 feet for take-off when fully loaded on hot days. The 707, as represented by the KC-135s, would need a maximum of 13,500 feet under the same conditions. For civilian airports, facility requirements, including runway length requirements, must be determined utilizing the critical civilian aircraft not military aircraft.

The runway length alternatives include an analysis of the cost to maintain the existing runway length over the next 20 years versus the cost to reduce the runway length by 2,401 feet in order to provide a total runway length of 10,500 feet. **Exhibit 4D** graphically presents the alternative of reducing the primary runway by 2,401 feet. Initial consideration is given to removing this length from the south end of the runway.

There are three primary reasons for directing any runway reduction to the south end of the runway. First, the southern 2,000 feet of the runway has a 15-foot rise in elevation. The standard for runway gradient over the first or last quarter of the runway is ± 0.8 percent. The existing grade is ± 1.0 percent of the last quarter of Runway 36. This nonstandard gradient has been an FAA approved modification to standards since 1990. Second, reducing the Runway 36 end would effectively bring the runway end closer to the terminal and ramp areas, thus reducing taxi times.

Finally, reducing the Runway 18 end by 2,401 feet would place the landing threshold approximately 600 feet south of Runway 14-32. This would lead to the RSA, OFA, and RPZs extending across Runway 14-32. The intersection of Runway 14-32 and 18-36 is already identified as an FAA hot spot, and reducing Runway 18 may lead to further potential confusion in the area.

Costs were developed for removing 2,401 feet of runway pavement from the southern portion of Runway 36. Cost estimates include the removal of pavement, relocation of the localizer, MALSR, and glideslope antenna as well as runway end light installation and application of new precision runway markings. Estimates were then developed for the maintenance of any new pavement and markings, such as the new connecting taxiways and holding aprons connecting Taxiways D and G to the new end of the runway. The cost for this runway length reduction is approximately \$10.75 million.

The cost of maintaining the current runway length assumes that the existing runway will be reconstructed in accordance with Option A, which maintains the runway at a width of 200 feet. This option was utilized in order to present a conservative estimate. The cost of rebuilding and then maintaining the southern 2,401 feet of Runway 18-36 and the overrun area is estimated at approximately \$2.3 million over the next 20 years. Therefore, it is more economical to rebuild and then maintain 2,401 feet of runway pavement versus removing 2,401 feet when considering the costs associated with relocating navigational aids and

runway lighting and remarking the runway.

One additional consideration when examining the runway length issue is recent capital expenditures for the runway. In 2007, the MALSR lighting on approach to Runway 36 is programmed to be replaced by the FAA. Replacement of MALSR lighting can cost \$1 million or more. To reduce the runway length would require the relocation of this new system which would be an added cost.

Taxiways and Hold Aprons

The FAA capacity and delay model, as presented in Chapter Three – Facility Requirements, indicated that overall airfield capacity can be increased if additional taxiway exits are in strategic places. High-speed, acute-angled taxiway exits are recommended where appropriate in order to allow for rapid exit from the runway and to improve overall airfield capacity. As such, two high speed exits extending from Runway 18-36 east to Taxiway D are considered and are graphically presented on **Exhibit 4E**.

The first exit could be located between Taxiways K and H. This exit would allow aircraft landing Runway 18 to exit the runway approximately 7,200 feet from the threshold. The second exit, located between Taxiway J and K, could provide rapid egress for aircraft landing Runway 36. This taxiway would be located approximately 7,800 feet from the Runway 36 threshold. If the runway were to be reduced in length by 2,400 feet, the taxiway would be located approxi-

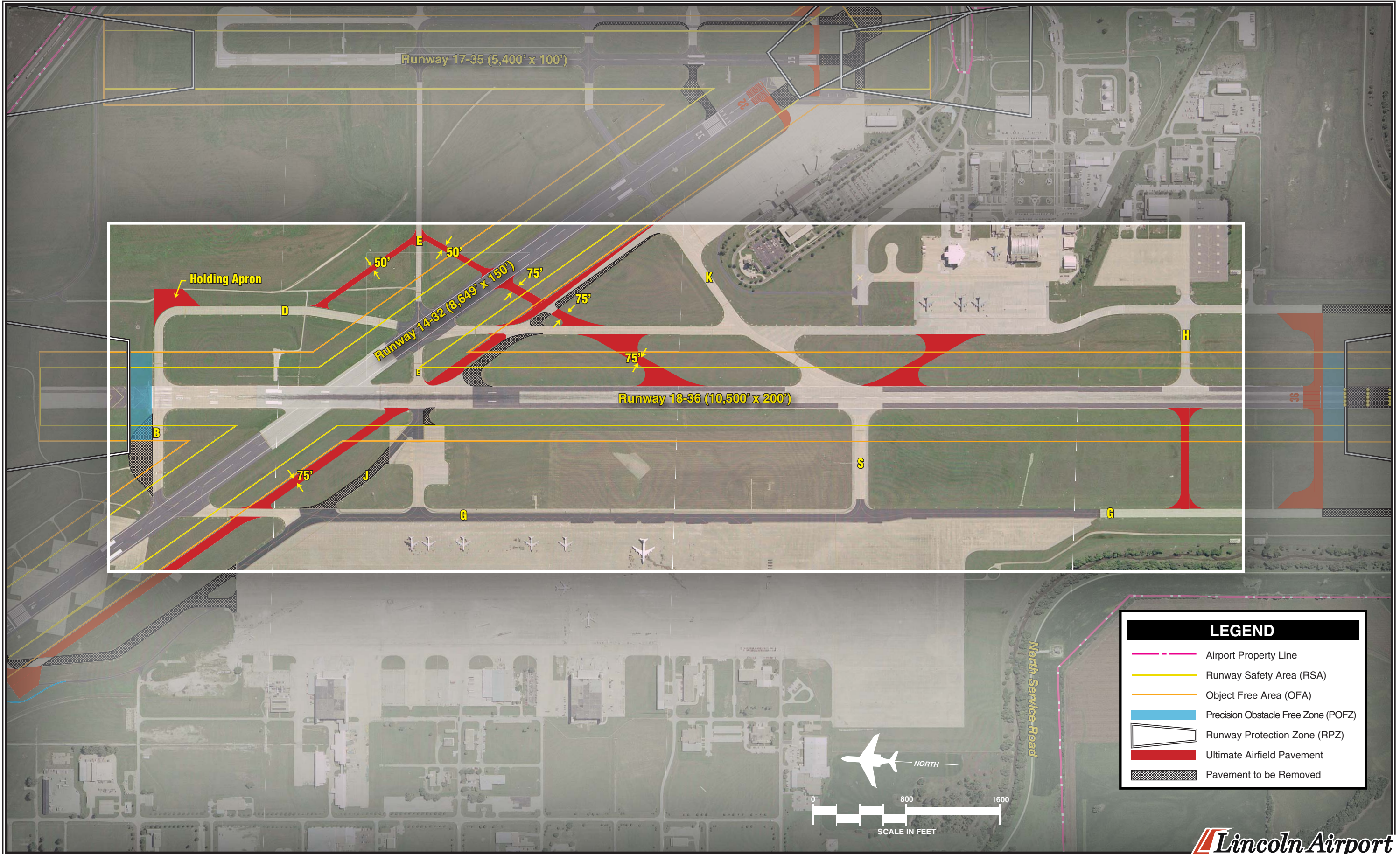

LEGEND

- · — · Airport Property Line
- Runway Safety Area (RSA)
- Object Free Area (OFA)
- Precision Obstacle Free Zone (POFZ)
- Runway Protection Zone (RPZ)
- Ultimate Airfield Pavement
- Pavement to be Removed

mately 5,400 feet from the Runway 36 threshold. The second taxiway would benefit overall capacity and efficiency regardless of the action taken on the runway length.

Exhibit 4E shows the proposed high speed taxiway exit located between Taxiways J and K, extending across Runway 14-32 and intersecting with Taxiway D. This design has the potential to add capacity and efficiency to ground movements. Aircraft landing Runway 36 will have an option to use this proposed taxiway to access the east ramp area without having to run out all the way to Taxiway E.

Taxiway H is shown extending from the runway to Taxiway G in this alternative. This taxiway would have a limited benefit to capacity, but it would allow for greater airfield circulation.

The previous master plan considered hold aprons at each end of Taxiway D. Hold aprons allow for more efficient sequencing of aircraft for take-off and they increase overall airfield capacity. Hold aprons are likely a long term project as forecast operational levels do not indicate an immediate need, but they should be considered as part of the plan. The previous master plan also included high-speed exits from Runway 18-36 to Taxiway G. The west side of the airport has been largely underutilized and high-speed exits leading to the west ramp, and should only be considered if west ramp activity increases substantially.

Taxiway B, between the Runway 18 threshold and Runway 14-32, can be confusing to pilots because of the

pavement “bump-out.” The “bump-out” is not usable pavement and should be removed to avoid pilots possibly confusing the “bump-out” with a hold apron.

Instrument Approaches

Runway 18-36 offers several instrument approach procedures. Both ends of the runway offer CAT I approaches, which offer visibility minimums as low as ½-mile and cloud height ceilings as low as 200 feet. This type of approach is typically offered at commercial service airports where weather is a factor. Some commercial service airports in locations where meteorological conditions can be below these minimums will pursue CAT II or CAT III approaches.

The CAT II approaches allow for operations when cloud ceilings are between 100 and 200 feet above ground level (AGL) and visibility is not lower than 1,148 feet (approx. ¼-mile). To accommodate this type of approach, the MALSR lights would have to be replaced with a high intensity approach lighting system with sequenced flashing lights (ALSF-2). Currently, Lincoln Airport meets all requirements except for the required 2,500 annual instrument approaches (AIAs) by air carriers over each of the previous three years. In addition, meteorological conditions falling below CAT I minimums have been experienced at the airport 0.06 percent of the time over the previous ten years.

The Lincoln Airport experienced 623 AIAs in 2005 and is projected to potentially reach 2,659 by the long term

planning horizon. Based on these forecasts, there does not appear to be a need to plan for a CAT II or III approach. If in the long term future these circumstances change dramatically, then the airport may consider an improved approach. The existing CAT I approaches to both ends of Runway 18-36 should be maintained.

The FAA is currently embarked on an aggressive program to utilize global positioning system (GPS) technology for CAT I and below approaches. The airport should pursue CAT I GPS approaches as they become available. Ultimately, CAT I GPS approaches may replace the traditional ILS equipment serving Runway 18-36.

Hot Spots

The FAA has identified two “hot spots” associated with Runway 18-36. Hot spots are locations on the airfield that have been known to cause pilot confusion and can potentially lead to runway incursions. The first is the potential confusion between the parallel runways for the approaches from the south. Pilots should use caution when lining up to the runway and be sure they are approaching the correct runway. There are no practical planning techniques that can further distinguish between the runway ends, so pilots should simply be aware that there are parallel runways at the airport.

The second “hot spot” is the potentially confusing intersection of Runway 18-36 and Runway 14-32 and the associated taxiways. The taxiway dimensions and markings meet FAA standards. One area that can be ad-

dressed with planning and design is where Taxiway J continues northwest from the intersection with Taxiway E. Pilots entering this area from Runway 18-36 may become confused as to which direction they should proceed.

Exhibit 4E presents an alternative that will separate Taxiways E and J and reduce the potential for pilot confusion. Currently, when a pilot crosses Runway 18-36 taxiing west they come to a divergence where Taxiway J splits off to the northwest, while Taxiway E continues to the west. The alternative presented would straighten Taxiway J to a uniform separation of 450 feet from the Runway 14-32 centerline.

An additional consideration for this “hot spot” is the intersection of Taxiway E and Runway 14-32. Currently, pilots taxiing from the east ramp to the Runway 18 threshold have to enter Runway 14-32 in order to access Taxiway D. This maneuver is not inherently unsafe, but it effectively reduces airfield capacity and can lead to runway incursions. **Exhibit 4E** depicts a 1,000-foot partial taxiway which connects Taxiways E and D. This proposed new taxiway connector would parallel Runway 14-32 at a separation of 800 feet (centerline to centerline).

RUNWAY 17-35

Runway 17-35 is 5,400 feet long by 100 feet wide. This runway primarily serves general aviation aircraft desiring to access the east ramp area. The dimensions of this runway meet FAA recommendations to accommodate 75

percent of business jets at 60 percent useful load. This category includes most cabin class business jets up to and including those in ARC C-II. The long term planning horizon forecasts a general aviation critical aircraft in ARC D-III. A runway length of approximately 6,500 feet would be necessary to fully accommodate these aircraft.

The possibility of extending Runway 17-35 to a length of 6,500 is not considered feasible. Any addition of pavement to the runway would extend the RSA beyond airport property on both runway ends. To the north the railroad tracks and North Park Road would have to be relocated. To the south, West Adams Street would have to be relocated. The following two alternatives will be considered for Runway 17-35:

- Maintain current length and “clean up” pavement layout.
- Relocate Runway 35 threshold to pavement end and implement declared distances.

Runway 17-35 Alternative 1

The first alternative for Runway 17-35 is designed to maintain its existing length in order to accommodate general aviation activity up to and including those business jets in ARC C-II. Operations conducted by larger business jets would be directed to utilize one of the other two runways as necessary. Thus, this alternative focuses on pavement layout intended to remove potential pilot confusion.

The Runway 35 threshold is preceded by approximately 400 feet of pavement which is marked as taxiway. This design is acceptable and meets FAA standards, but it is preferable to have the runway thresholds at the end of the pavement if possible.

Alternative 1, as shown on **Exhibit 4F**, presents the possibility of adding entrance/exit taxiways to both sides of the existing Runway 35 threshold. This is a more traditional design and reduces the potential confusion of the lead-in taxiway being aligned with the runway. As presented, those pavement surfaces south of the Runway 35 threshold would then be removed.

Runway 17-35 Alternative 2

The second alternative considers relocating the Runway 35 landing threshold to the pavement end and implementing declared distances. Since completion of the previous master plan, the FAA changed the RSA standard which had required 1,000 feet of RSA prior to runway ends for an aircraft on approach. Now, the FAA requires 600 feet of RSA prior to landing; however, they still require 1,000 feet beyond the far end of the runway. Through the implementation of declared distances, the Runway 35 threshold can be moved back to the pavement end as 600 feet is available prior to the threshold. **Exhibit 4G** presents this alternative.

Declared distances are the effective runway distances that the airport operator declares available for take-off run, take-off distance, accelerate-stop

distance, and landing distance requirements. These are defined by the FAA as:

Take-off run available (TORA) - The length of the runway declared available and suitable to accelerate from brake release to lift-off, plus safety factors.

Take-off distance available (TODA) - The TORA plus the length of any remaining runway or clearway beyond the far end of the TORA available to accelerate from brake release past lift-off to start of take-off climb, plus safety factors.

Accelerate-stop distance available (ASDA) - The length of the runway plus stopway declared available and suitable to accelerate from brake release to take-off decision speed, and then decelerate to a stop, plus safety factors.

Landing distance available (LDA) - The distance from threshold to complete the approach, touchdown, and decelerate to a stop, plus safety factors.

The ASDA and LDA are the overriding considerations in determining the runway length available for use by aircraft because safety areas must be considered. The ASDA and LDA can be figured as the useable portions of the runway minus the area required to maintain adequate RSA beyond the end of the runway.

By relocating the landing threshold to the pavement end, two airfield goals can be accomplished. First, Taxiway A would connect directly to the run-

way end, which is a more standard and efficient layout. Second, 400 feet of operational length for take-offs to the north can be gained. Operations utilizing Runway 17 would still have 5,400 feet available.

The FAA presents further guidance on declared distances in AC 150/5300-13, Change 10, *Airport Design*: “The use of declared distances for airport design shall be limited to cases of existing constrained airports where it is impracticable to provide the RSA, the OFA, or the RPZ in accordance with the design standards...” This basically means that the FAA does not want an airport to build into a situation where declared distances are necessary.

When comparing the two alternatives presented for Runway 17-35, the FAA may support the use of declared distances as presented in Alternative 2. Alternative 2 presents a significant cost savings over Alternative 1 that requires pavement construction and removal.

Relocating the Runway 35 threshold and implementing declared distances would require re-marking a portion of the runway, relocating the runway end lights, relocating one set of PAPIs, and relocating at least two ODALS light stands. This cost would be negligible when compared to adding taxiways to the existing threshold and removing the excess pavement as presented in Alternative 1.

Exhibit 4G also presents an alternate location for the service road to the east of the Runway 35 threshold. This service road currently traverses the OFA

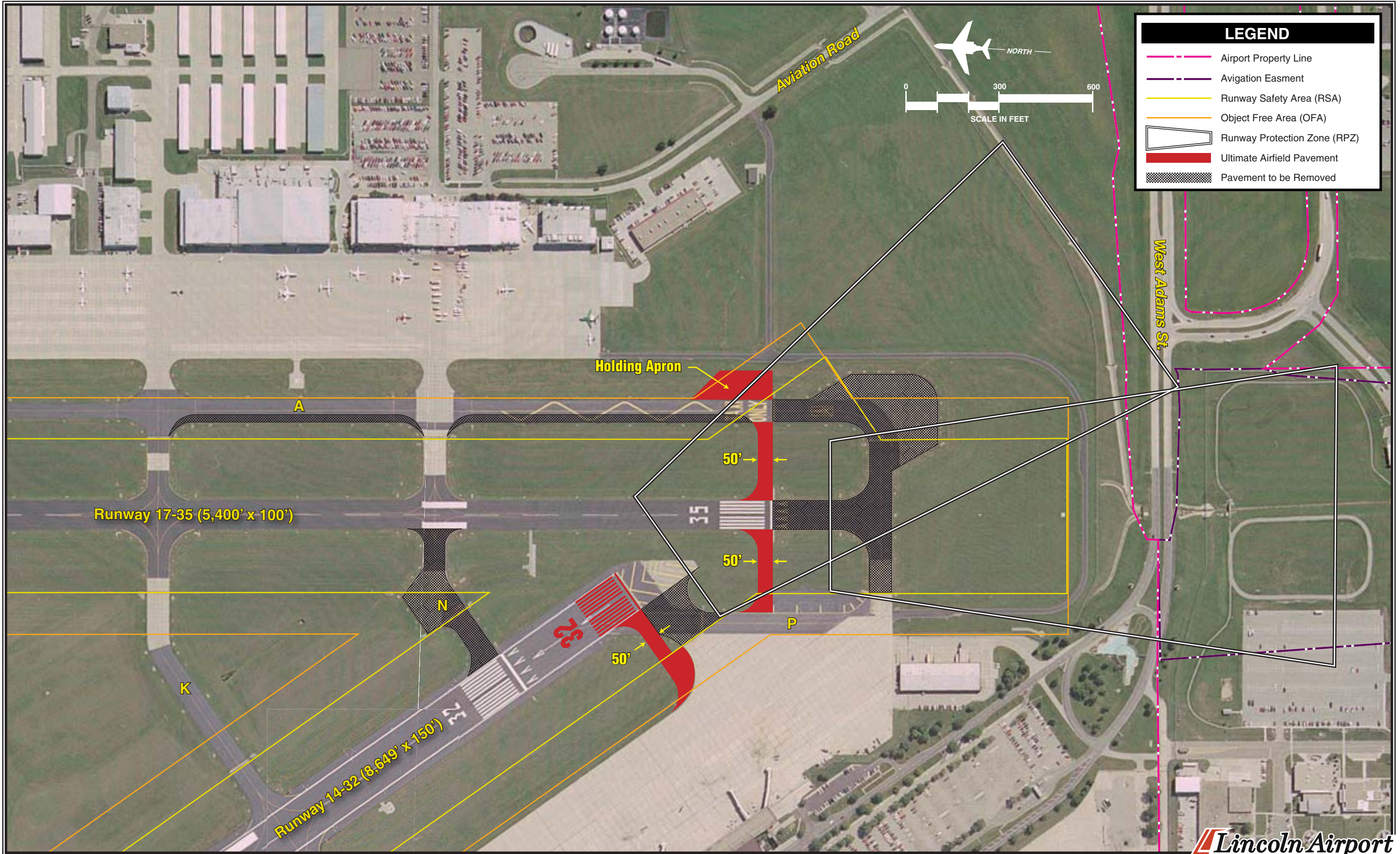

04MP20-4G-2/13/07

LEGEND

- - - Airport Property Line
- - - Avigation Easment
- - - Runway Safety Area (RSA)
- - - Object Free Area (OFA)
- Runway Protection Zone (RPZ)
- Pavement to be Removed

| RUNWAYS | DECLARED DISTANCES | |
|-----------|--------------------|--------|
| | ASDA | LDA |
| Runway 17 | 5,400' | 5,400' |
| Runway 35 | 5,800' | 5,800' |

SCALE IN FEET

0 800 1600

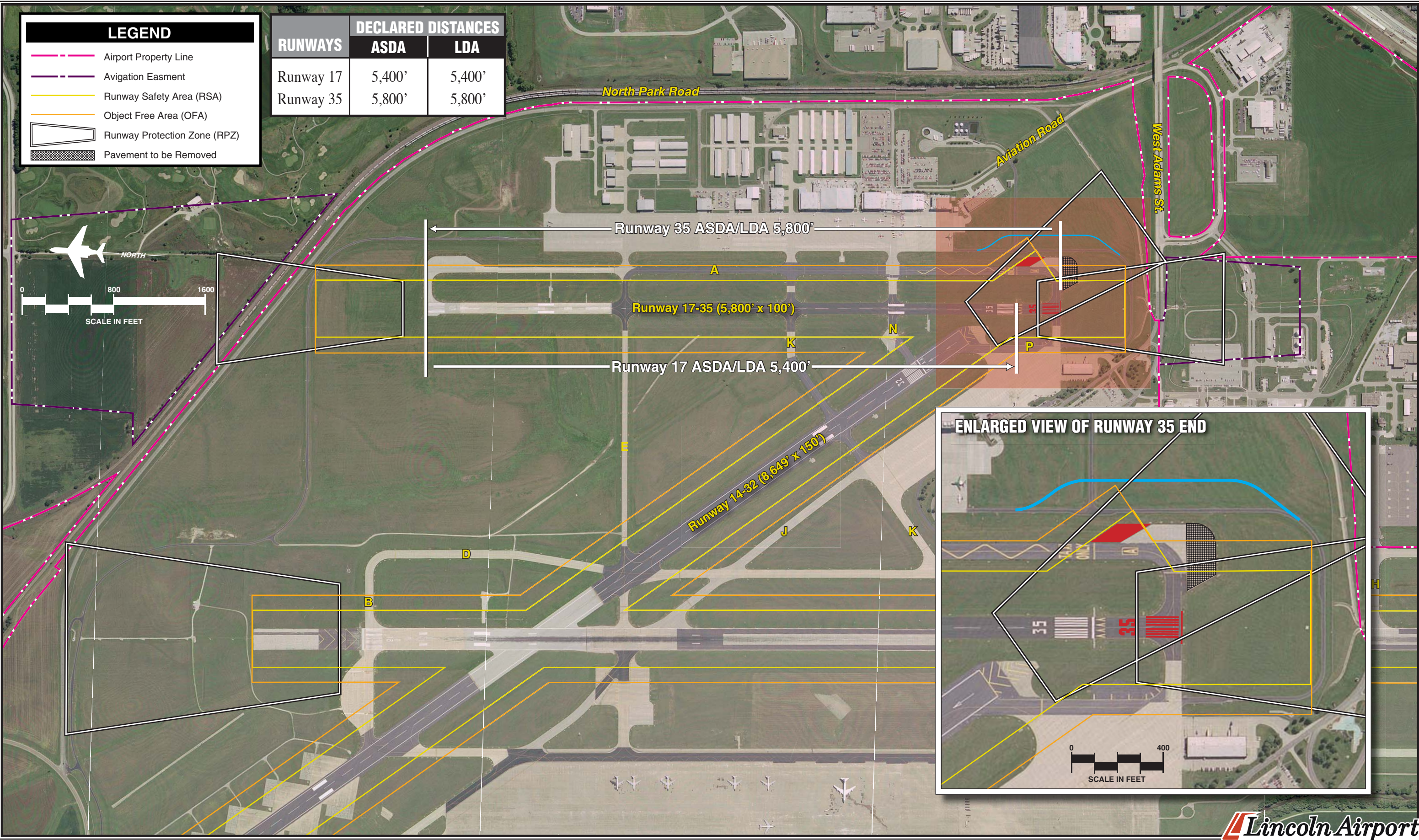

ENLARGED VIEW OF RUNWAY 35 END

SCALE IN FEET

0 400

associated with Runway 14-32 and should be relocated.

Hot Spots

In the past there have been several occasions when aircraft intending to land on Runway 35 instead land on Taxiway A. This is obviously a very dangerous circumstance. The Lincoln Airport Authority has recently applied a nonstandard serpentine line on the southern 800 feet of Taxiway A in order to further alert pilots when they are lined up on the taxiway instead of Runway 35. The FAA has agreed to allow the marking to remain as a test project.

Two other options are supported by the FAA. The first is to mark the taxiway with standard marking that says "TAXI." The current marking says "TAXI ONLY" which is acceptable, but it has not prevented inadvertent landings. The second method is to install a lighted "X" on the taxiway centerline as close as possible to the taxiway end. The Lincoln Airport Authority should consider this solution in the future as there has been at least one landing on the taxiway since the serpentine line was applied.

There are several theories as to why there is persistent confusion about the approach to the runway. One problem may be that the 75-foot wide Taxiway A is similar in width to the 100-foot wide runway. The taxiway width design standard for aircraft in Airplane Design Group (ADG) D-II is 35 feet, while the standard for aircraft in ADG III is 50 feet. This alternative considers reducing the width of Taxiway A to

a uniform 50-foot width and is presented on **Exhibit 4F**.

A second theory on the confusion is that the hold line on Taxiway A at the same distance as the landing threshold to Runway 35 may give the impression of parallel runways to pilots. This hold line is to prevent incursions when there is an operation to Runway 32. Staggering this hold line and the Runway 35 landing threshold may help reduce pilot confusion.

Exhibit 4G presents a second option for solving this hot spot issue by maintaining the current Taxiway A width at 75 feet in conjunction with relocating the landing threshold to the pavement end. Having the runway and taxiways meeting at the runway end is more typical and will likely reduce the confusion pilots have between the runway and taxiway. That portion of the holding apron that extends beyond the lateral edge of the runway end would also be removed. The remaining hold apron could then be expanded as needed.

Instrument Approaches

Runway 17 is served by a VOR or GPS straight-in and circling approach. The visibility minimum associated with this approach is one-mile with 600-foot cloud height ceilings. With the advances being made in avionics for general aviation aircraft, improved approaches should be considered. A straight-in GPS approach should be considered for Runway 35 with not lower than one-mile visibility minimums. During times of poor visibility, general aviation aircraft can utilize

the more sophisticated ILS approaches on primary Runway 18-36.

RUNWAY 14-32

Runway 14-32 measures 8,649 feet long by 150 feet wide. This runway provides critical cross wind coverage and is capable of accommodating operations by the air carriers currently operating at the airport. This runway should be maintained as a capable back-up runway for air carrier operations.

The landing threshold on Runway 14 is displaced 363 feet in order to provide for the required 1,000 feet of RSA. As previously mentioned, the FAA has changed the RSA requirement prior to landing from 1,000 feet to 600 feet. The 1,000-foot RSA standard still applies to the departure end of the runway. Because of this change, the landing threshold to Runway 14 can be relocated back to the pavement end, as 637 feet of RSA would still be available prior to landing.

The airport currently publishes declared distances in association with this runway. The ASDA for Runway 14 is 8,649 feet. The LDA is 8,286 feet because of the displaced landing threshold. When applying the new RSA standard of 600 feet prior to landing, the full runway length can be made available for landing operations to Runway 14. This is depicted on **Exhibit 4H**.

The ASDA for Runway 32 is currently 8,286 feet because the landing threshold is displaced 470 feet. For several years, the purpose of this landing threshold displacement has been in doubt. Detailed airport obstruction survey analysis, to be included as a drawing in the Airport Layout Plan (ALP) set, indicates there are no obstructions to the approach surface were this landing threshold relocated to the pavement end. As a result, **Exhibit 4H** depicts the relocation of the landing threshold for Runway 32 to the pavement end. **Table 4B** presents both the existing declared distances as applied to Runway 14-32 as well as the potential new declared distances when reclaiming the maximum available pavement.

| TABLE 4B Runway 14-32 Declared Distances Lincoln Airport | | | | |
|---|------------------------------------|------------------|------------------------------------|------------------|
| | Existing Declared Distances | | Proposed Declared Distances | |
| | Runway 14 | Runway 32 | Runway 14 | Runway 32 |
| ASDA | 8,649 | 8,286 | 8,649 | 8,286 |
| LDA | 8,286 | 7,816 | 8,649 | 8,286 |
| TORA | 8,649 | 8,649 | 8,649 | 8,649 |
| TODA | 8,649 | 8,649 | 8,649 | 8,649 |

ASDA: Accelerate-stop distance available
 LDA: Landing distance available
 TORA: Take-off run available
 TODA: Take-off distance available

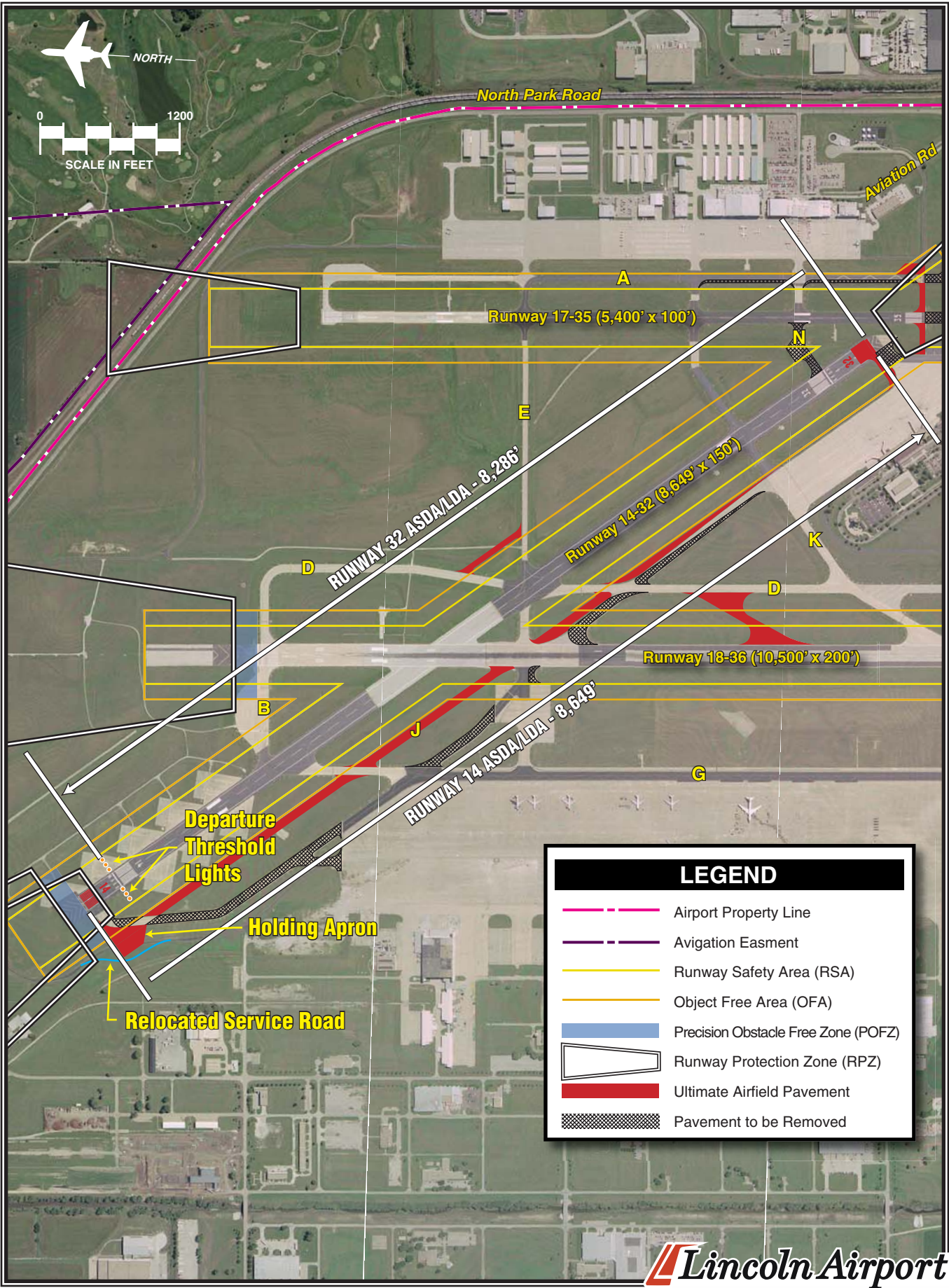

Hot Spots

There are two hot spots primarily associated with Runway 14-32. The hold line for aircraft traveling south on Taxiway A when aircraft are on approach to Runway 32 is located 400 feet from the south end of Taxiway A. This may be a contributing factor to the confusion between the runway and taxiway by pilots on approach to Runway 35. One method is to shorten Runway 14-32 by approximately 400 feet. This would remove the need for a hold line on Taxiway A. Since the full runway length is considered essential, a runway reduction is not considered practicable. As a result, the Runway 32 approach hold line on Taxiway A will have to remain. A second option may be to install In-Pavement Runway Guard Lights immediately prior to the Taxiway A hold line. This solution is further defined in AC 150/5340.3DB, *Design and Installation Details for Airport Visual Aids*. It should be noted that with proper lighting and marking, this hold line location is not unsafe.

The second hot spot is Taxiway N between Runway 17-35 and Runway 14-32. Aircraft needing to hold on this portion of Taxiway N must hold at the second hold line they encounter. At the direction of the FAA, the airport has provided appropriate pavement marking and has installed elevated runway guard lights (oscillating ground level light fixtures) at the appropriate hold line for approaching aircraft.

Several possible alternatives were examined which would help prevent

runway incursions in this area. The first possibility is to completely remove this portion of Taxiway N, as depicted on **Exhibits 4H and 4F**. By removing Taxiway N, obviously there would be no way for an aircraft to inadvertently cause a runway incursion. The negative side to this alternative is that airfield efficiency would be negatively impacted.

A second option would be to not allow aircraft to hold on Taxiway N between the runways. This alternative would also negatively impact airfield efficiency as aircraft would have to hold on the east ramp prior to proceeding to the Runway 32 threshold for take off. This would basically eliminate the possibility of conducting simultaneous operations on Runway 14-32 and Runway 17-35 since aircraft would have to have a clear path from Runway 14-32 to the east ramp.

The value to aircraft movement efficiency of allowing aircraft to both utilize Taxiway N and to hold between the runways seems to outweigh the cost of the available hot spot solutions. In fact, the current marking and lighting configuration for Taxiway N provides an added measure of safety.

Instrument Approaches

Runway 14 offers an LNAV approach with circling capability. For all practicable purposes, this is a GPS approach which offers one-mile visibility minimums and 400-foot cloud height ceilings. The previous master plan considered the possibility of a CAT I GPS approach to the Runway 14 end.

Traditional ground-based navigational equipment is still required for CAT I GPS approaches. At the same time, new ILS equipment is not being supported by the FAA except in very rare circumstances. The FAA is instead certifying localizer performance with vertical guidance (LPV) approaches which have been approved with minimums down to one mile without the need to purchase costly ILS equipment to provide the precision component. The approach to Runway 14 should ultimately be planned to CAT I standards.

The Runway 32 end may also be planned to CAT I standards in the long term but a new approach with vertical guidance (precision), such as an LPV approach, is needed in the short term. This approach would provide a needed approach for commercial aircraft at times when weather conditions make this the optimal landing runway. In addition, when Runway 18-36 is reconstructed in the next few years, the airport will need this new approach to minimize the potential diversion of commercial flights.

AIRSPACE ANALYSIS

The final airfield consideration is protecting the area airspace from potential flight obstructions. The FAA has established criteria aimed at protecting the airport from these flight obstructions. First, the FAA criterion stipulates that objects not be placed too near the runway ends or parallel to the runway. The obstruction clearance requirements are based on the critical aircraft and the type of ap-

proaches at the airport. For visual approaches and/or not lower than one-mile visibility approaches for ARC B-II aircraft, minimum obstruction clearance is required. For ARC C/D-II aircraft, however, the obstruction criterion is more protective.

Alternatives previously presented recommended improved instrument approach procedures to Runways 17, 35, and 14. In addition, the feasibility of relocating the landing thresholds for Runways 35, 14, and 32 to the usable pavement ends is also considered. These airfield improvements have been analyzed from an airspace perspective.

Federal Aviation Regulation (FAR) Part 77, *Objects Affecting Navigable Airspace*, was established for use by local authorities to control the height of objects near airports and is a tool to aid local authorities in determining if proposed development could present a hazard to aircraft using the airport.

The FAR Part 77 regulations assign three-dimensional imaginary areas to each runway. These imaginary surfaces emanate from the runway centerline and are dimensioned according to the visibility minimums associated with the approach to the runway end and size of aircraft to operate on the runway. The FAR Part 77 imaginary surfaces include the primary surface, approach surface, transitional surface, horizontal surface, and conical surface. Preliminary analysis of the FAR Part 77 approach surface was conducted on the existing runway system at the Lincoln Airport.

There are currently seven FAR Part 77 penetrations to the approach surface of Runway 35, while there are two approach surface (50:1) penetrations to Runway 36. All other approach slopes are free of FAR Part 77 penetrations. Penetrations to FAR Part 77 surfaces do not necessarily indicate a hazard to aviation; instead, those penetrations are tested against the more restrictive Threshold Siting Surface (TSS) for each runway end.

The TSS is described in Terminal Instrument Procedures, or TERPS. TERPS is the critical tool in determining actual flight obstruction. In fact, TERPS analysis is used to evaluate and develop instrument approach procedures, including visibility minimums and cloud heights associated with the approaches. The first filter included in TERPS is the identification of any penetrations to the TSS.

The TSS is defined by the type of approach and aircraft using the approach. The TSS for both ends of Runway 18-36 extends out from the runway at a 34:1 slope. There are no penetrations to the TSS serving Runway 18-36. The TSS for all other runways extends out at a 20:1 ratio currently. There is a tree that penetrates the existing Runway 35 TSS by 2.3 feet while all other ends have clear TSS.

The last FAR Part 77 penetration is the windcone serving the Runway 17 end. This windcone is in the primary surface which is allowable as it is considered fixed by function.

Advisory Circular 150/5300-13, *Airport Design*, requires consideration of

a departure surface. The departure surface is represented by a trapezoid shape extending from the runway pavement end and extending up at a 40:1 ratio for all runways utilized by aircraft making instrument departures. The purpose of the departure slope is to provide an added measure of safety for departing aircraft in poor weather conditions or at night.

The departure surface begins at the end of the usable pavement, is 1,000 feet wide, and extends 10,200 feet to an ultimate width of 6,466 feet. There are three recommended methods to mitigate penetrations to the departure surface.

1. The object is removed or lowered;
2. The Takeoff Distance Available (TODA) is decreased (i.e., pilots are instructed to lift-off prior to the runway end in order to avoid the obstruction); and
3. Instrument departure minimums are raised.

It should be noted that obstacles of 35 feet or less do not require the above mitigation methods; instead, new departure procedures may be introduced or existing departure procedures may be altered.

There are currently several departure surface penetrations at the airport. The railroad tracks north of Runway 17 present a penetration. (Twenty-three feet are added to the surface elevation of railroad tracks.) There are also departure surface penetrations beyond Runways 32 and 35. There are

no departure surface penetrations to Runways 18, 36, and 14.

For departure runway ends supporting air carrier operations, such as Runway 18-36 and Runway 14-32, the AC also introduces a one-engine inoperable (OEI) surface. The airport is instructed to identify any objects that penetrate this surface, which is similar but longer than the departure surface in dimensions, but is represented by a 62.5:1 slope ratio. The airlines must utilize this information to develop safe procedures in the event of an engine loss on departure. No mitigating action has to be taken by the airport if penetrations are found.

There are no OEI surface penetrations to the north of Runway 18. There are seven OEI surface penetrations to the south of Runway 36. These penetrations include three poles, one light-pole, two trees, and one building. There are five OEI (62.5:1) penetrations for Runway 14.

Airspace Summary

If the Runway 14 landing threshold were relocated to the pavement end there would be no FAR Part 77 (50:1) or TSS (34:1) obstructions. This would accommodate a CAT I approach. If the Runway 32 landing threshold were relocated to the usable pavement end there would be no FAR Part 77 (34:1) or TSS (20:1 or 34:1) obstructions.

There are currently seven FAR Part 77 penetrations to the approach slope serving Runway 35, all of which are less than ten feet. These penetrations

would still exist if the threshold were relocated to the intersection with Taxiway A. There is(are) a tree(s) that currently penetrate(s) the TSS to Runway 35 by 2.3 feet. If the Runway 35 threshold is moved back, this penetration remains but is still less than ten feet.

Based on preliminary airspace analysis, the landing thresholds for Runway 14, 32, and 35 can all be relocated to the ends of the usable pavement. In addition, improved approaches to Runways 17, 35, and 14 are also feasible from an airspace perspective. Further analysis of these various surfaces surrounding the runways will be presented as technical drawings included with the Airport Layout Drawing set to be included in this master plan.

LANDSIDE ALTERNATIVES

The Lincoln Airport Authority has been active in ensuring that activity at the airport is appropriately separated and that adjacent land uses are compatible. This has led to the airport being a viable community asset for the foreseeable future. Allowing development of airport property that does not follow a strategic plan will lead to an inefficient and constrained facility.

The major activity centers of the airport such as the general aviation ramp, the commercial passenger terminal building complex, the ARFF facilities, and the military facilities are all distinct and separate from each other. This existing development follows recommended strategies to insure the long term efficiency of the airport.

The airport planning efforts should maximize existing property in an efficient manner that will serve demand well beyond the 20-year planning period, as well as provide flexibility for marketing and development. In order to provide a functional facility which meets all potential development needs, areas best suited for specific development should be identified. First, essential development elements to serve airfield, passenger airline, general aviation, and military needs must be considered, which includes support functions such as airport maintenance, ARFF, and fuel storage. Then areas for other land uses can be considered such as aviation-related commercial development and non-aviation revenue enhancement areas.

The airport should also be aware of the development patterns surrounding the airport. To insure the viability of the airport, any development immediately adjacent to the airport should be of a compatible nature. For example, planned residential development off the end of the runways should be avoided. Where possible, the airport should take a proactive role in limiting incompatible land uses around the airport. This may include strategic property acquisition.

One area of immediate consideration for acquisition would be the property to the immediate southwest of the airport. This property represents approximately 256 acres and extends from the airport property to Interstate 80. This property is located along the Runway 36 flight line. All flight line property should be owned by the airport if possible. The airport should also pursue this property in order to

protect the airport from incompatible land uses. There is currently pressure from developers to ultimately build residential housing in this location. If this property were to be developed for residential uses, there is the potential for an adverse environmental impact due to potential noise concerns. **Exhibit 4J** shows the location of this property.

Other landside issues to be discussed include the adequacy of air cargo facilities, fuel farms, general aviation automobile parking, employee parking and overall airport security.

PASSENGER TERMINAL BUILDING ALTERNATIVES

The passenger terminal building at an airport is the primary interface between surface and air transportation. As such, its purpose is to provide for the safe, efficient, and comfortable transfer of passengers and their baggage to and from aircraft and to various methods of ground transportation. To accomplish this, a passenger terminal building must contain several essential components to include ticketing, passenger processing, and baggage handling. These functions are supported by concession areas, rental cars, restrooms, and airline offices.

An airport passenger terminal building is similar in many respects to other transportation terminals but has some distinctly different characteristics. Airports place a greater reliance on the use of private automobiles for access to and from the airport, creating a need for adequate roadway and

parking facilities. But like other terminal buildings, the ground time of an aircraft is minimized; therefore, airport terminal buildings must be able to accommodate condensed peak passenger and baggage situations.

A terminal building typically provides several separate and distinct functional areas. These functional areas include ticketing, airline office space and baggage make-up, departure area, bag claim, and other terminal services. Ticketing refers not only to airline ticket counters, but also to a ticket lobby for the queuing of passengers. Ticketing counters should be situated near the entrance, clearly visible, and readily accessible from the terminal curb. Airline office and baggage make-up refers to an area for airline personnel to complete administrative tasks as well as collect outbound baggage. A separate baggage make-up area is important for baggage security, theft prevention, and sorting. These areas are usually situated directly behind the ticket counters with controlled access.

The departure area refers to an area where passengers wait to board an aircraft. Commonly, this is a secure area, separated from other public areas within the terminal building. All passengers and carry-on luggage are screened prior to entry. This can include ground level boarding areas, as well as second level boarding areas with jetways.

The baggage claim area refers to an area for the unloading of baggage, a bag claim counter for the displaying of

baggage, as well as lobby area for passengers awaiting baggage. Ideally, the bag claim facility should be conveniently located along the route of arriving passenger flow and in close proximity to the terminal curb.

Terminal services refer to the many ancillary services typically found in a terminal building. These can include a concessions area (such as a newsstand, gift shop, or restaurant) and rental cars facilities. The rental car counters are best placed near the bag claim facility, in line with the arriving passenger flow. The other terminal services can be placed in common circulation and waiting areas.

Of particular importance is the placement of these functional areas within the terminal building and the passenger flow between each area. Generally speaking, departing passengers should first encounter the ticketing areas, then easily flow to airport security and finally to the secure hold lobby. Arriving passengers should be able to flow from the aircraft to baggage claim and rental car counters and finally to the terminal curb. These two passenger flows should remain separated to the greatest extent possible for maximum efficiency.

Overall, an efficient terminal layout will provide adequate circulation area. The amount of circulation area varies, but at a minimum, circulation space should be provided in the ticketing and bag claim areas to minimize the disruptions of passenger queues at the ticketing and bag claim counters.

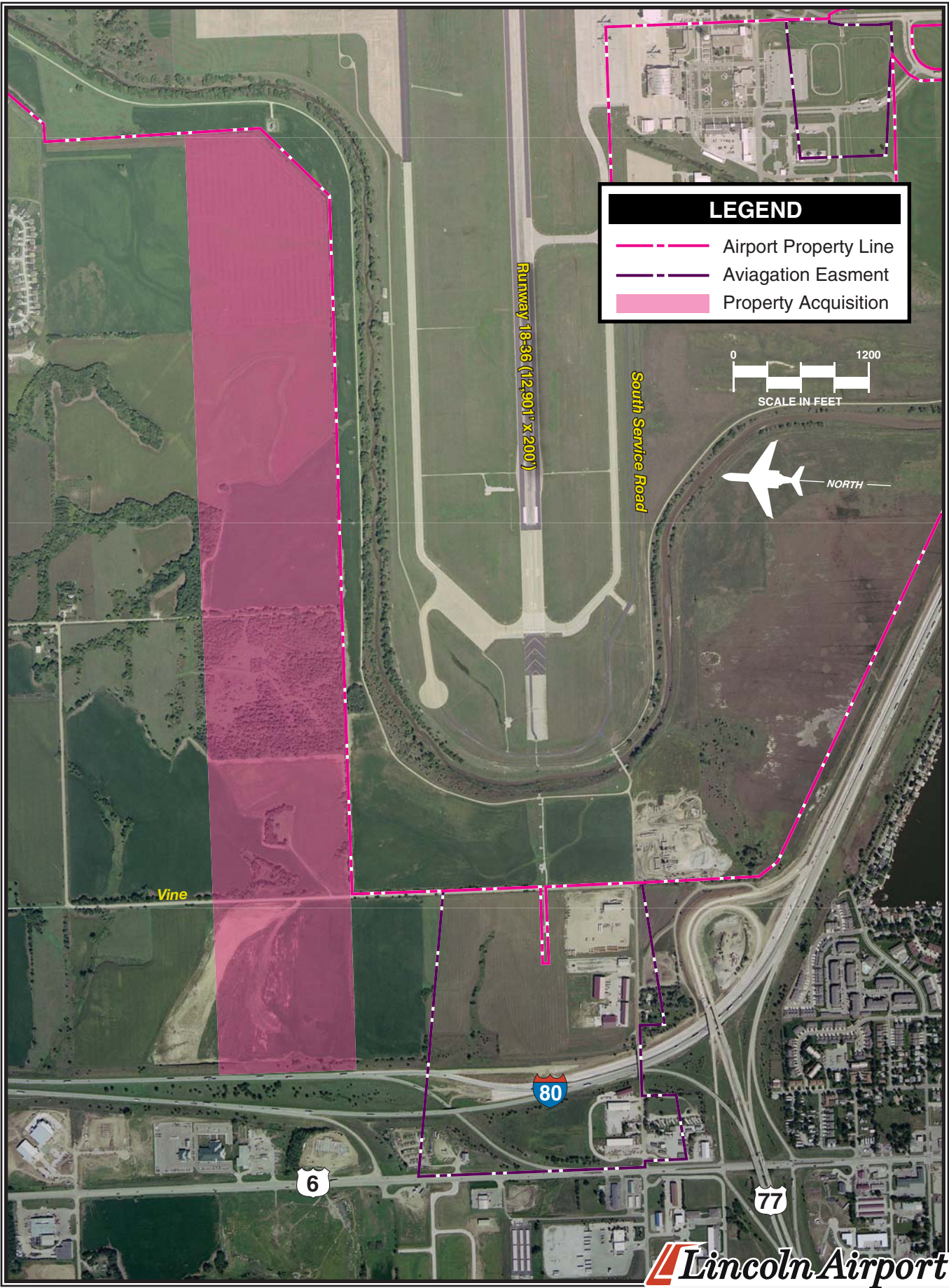

TERMINAL BUILDING ALTERNATIVES

The Lincoln Airport terminal building has served the community for over 30 years. The structure has been maintained in excellent condition. There has not been a need for any major additions to the terminal building since its construction, but there have been several internal redesigns intended to enhance passenger comfort and safety.

After the events of September 11, 2001, security and screening functions changed dramatically, requiring more functional space. Currently, checked baggage is screened in the ticketing lobby, and the passenger screening activities on the second floor can lead to long lines and congestion.

The current terminal building layout requires two separate passenger screening areas. Arriving and departing passengers are forced to intermingle on the second floor and at the escalators. Ideally, security functions could be centralized, and arriving and departing passengers could be separated.

The previous airport master plan considered three possibilities for expansion of the terminal building. Although there is not currently a need for major expansion of the building, it is prudent to keep expansion possibilities on record in the event that passenger enplanement levels increase unexpectedly beyond the long term forecast. The three options are presented in **Exhibit 4K**.

Scheme A proposed expanding the terminal building to the east toward

the aircraft apron. Both holding rooms would be expanded and circulation would be added between the hold rooms. The security checkpoints would be consolidated to a central location.

Scheme B also proposed shifting circulation to the east side of the building but adding hold room space on the west side of the building. Security checkpoints would also be centralized in this scheme.

Scheme C proposed adding a holdroom to either the north or south end of the terminal building while maintaining passenger circulation at its current location.

Exhibit 4L presents a design alternative for the second floor that can improve the efficiency of arriving and departing passenger flows. This is accomplished by expanding the second floor hold rooms and providing additional space for security functions. By shifting the security functions, arriving and departing passenger flows can be better separated and lines at the security checkpoints can be shifted away from the second floor circulation areas.

The inset on **Exhibit 4L** shows first floor building expansion to the south. This area is considered for relocation of the baggage screening functions which currently take place in front of the ticket counter, in the airport lobby area. The area identified would be contiguous with the existing baggage make-up area. The baggage conveyor belt can then be rerouted to enter this screening area in order to increase baggage screening efficiency. In addi-

tion, relocating the baggage screening area will provide much needed space in front of the south ticket counter. Consideration should be given to constructing the first floor addition to standards that would support a second floor in the future.

Any terminal building expansion options would be costly and difficult to justify unless long term forecast passenger enplanement levels are realized. In the interim, airport management should continue to adjust to passenger needs with internal remodeling on an as needed basis.

GENERAL AVIATION DEVELOPMENT ALTERNATIVES

General aviation facilities to be accommodated at Lincoln Airport include aircraft storage and maintenance hangars, aircraft parking apron, and parcels specifically designed to accommodate businesses requiring airfield access. The interrelationship of these functions is important to defining a long term general aviation layout for the airport.

General aviation development should follow a basic philosophy of separating low, medium, and high activity levels. High activity areas would be located central to the runway and should be reserved for fixed base operators (FBOs) or larger corporate flight departments. These types of businesses typically experience regular aircraft ingress and egress to larger conventional hangars. Conventional hangars in high activity areas should be a

minimum of 6,400 square feet (80 feet x 80 feet). If space is available, it is more common to plan these hangars for 150 feet by 150 feet to 200 feet by 200 feet.

The medium activity category defines the next level of airport use and includes areas that should be set to either side of the high activity areas. Typically hangars intended for medium activity intensity will house specialty airport businesses or smaller corporate flight departments. These hangars should be a minimum of 50 feet by 50 feet and should have the availability of basic utilities, including sanitary sewer.

The low activity use category typically defines the area for storage of smaller single and twin-engine aircraft. Low activity users are recreational or small business aircraft owners who prefer individual space in T-hangars or small box hangars. Low activity areas should be located in less conspicuous areas, off or to the ends of the flight line.

In addition to the functional compatibility of the general aviation area, the proposed development concept should provide a first-class appearance for Lincoln Airport. Consideration to aesthetics should be given high priority in all public areas, as the airport often serves as the first impression a visitor may have of the community.

GENERAL AVIATION ALTERNATIVES

The overall layout of general aviation facilities has followed a strategic plan

LAYOUT SCHEME A

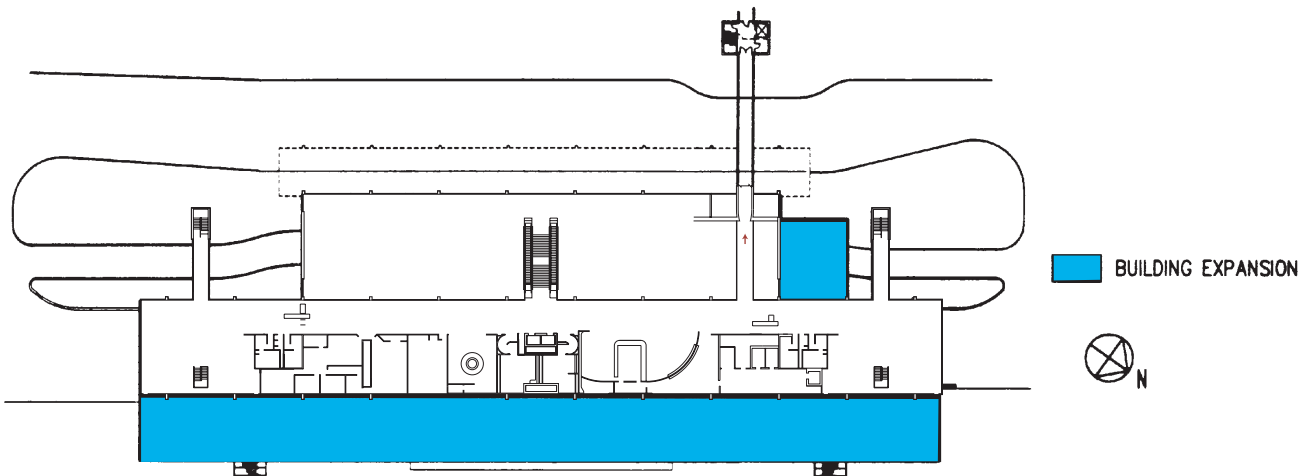

LAYOUT SCHEME B

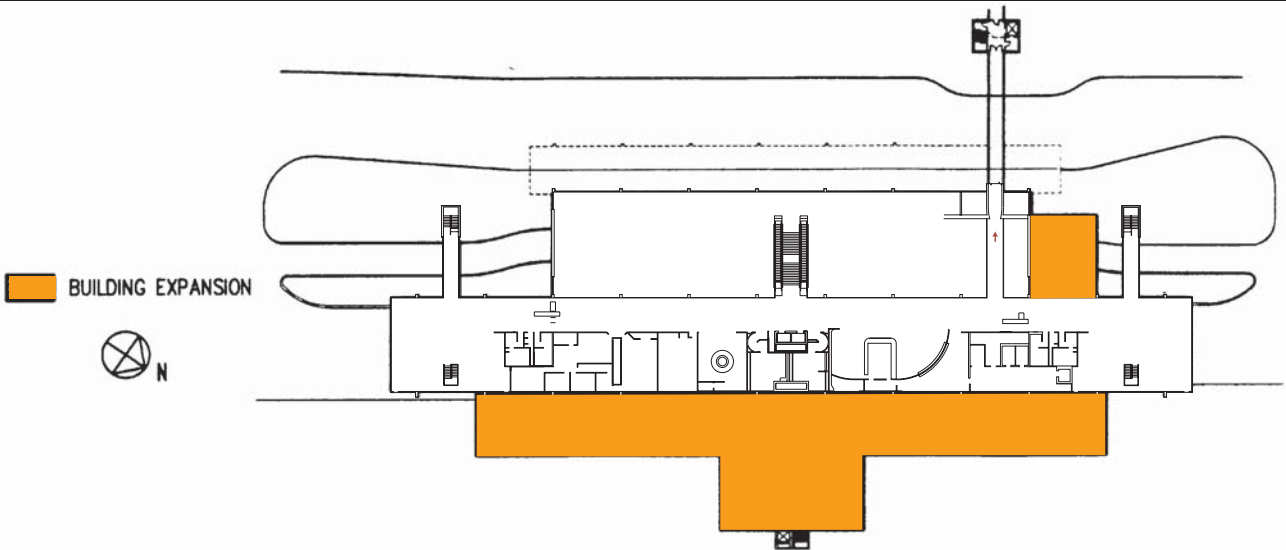

LAYOUT SCHEME C

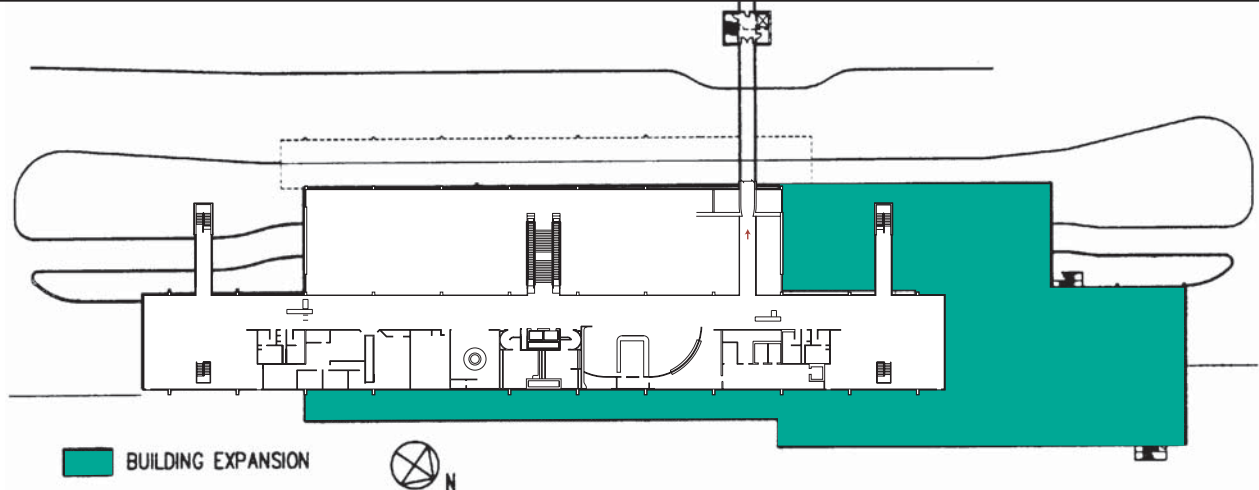

SECOND FLOOR PLAN

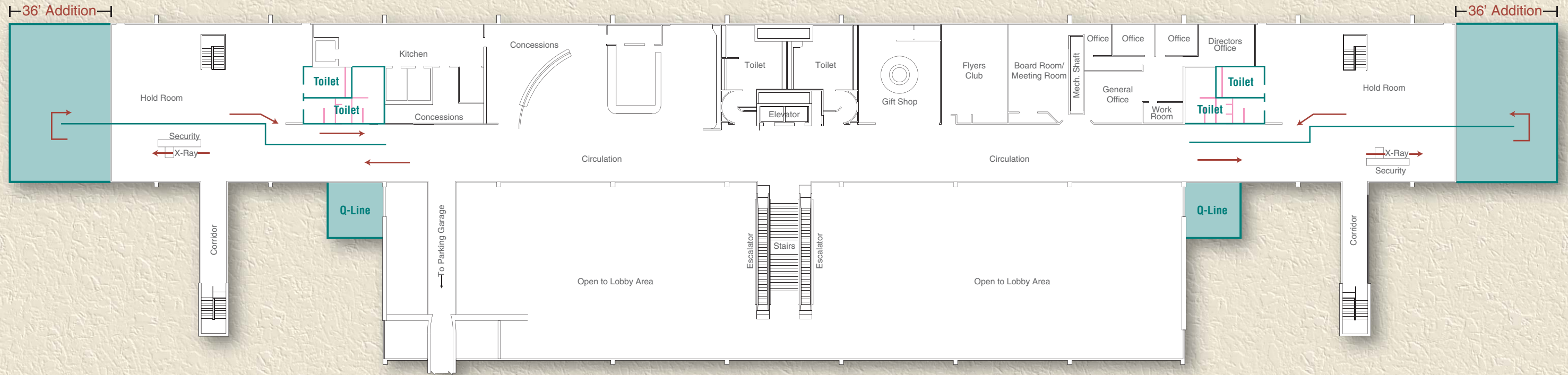

FIRST FLOOR PLAN

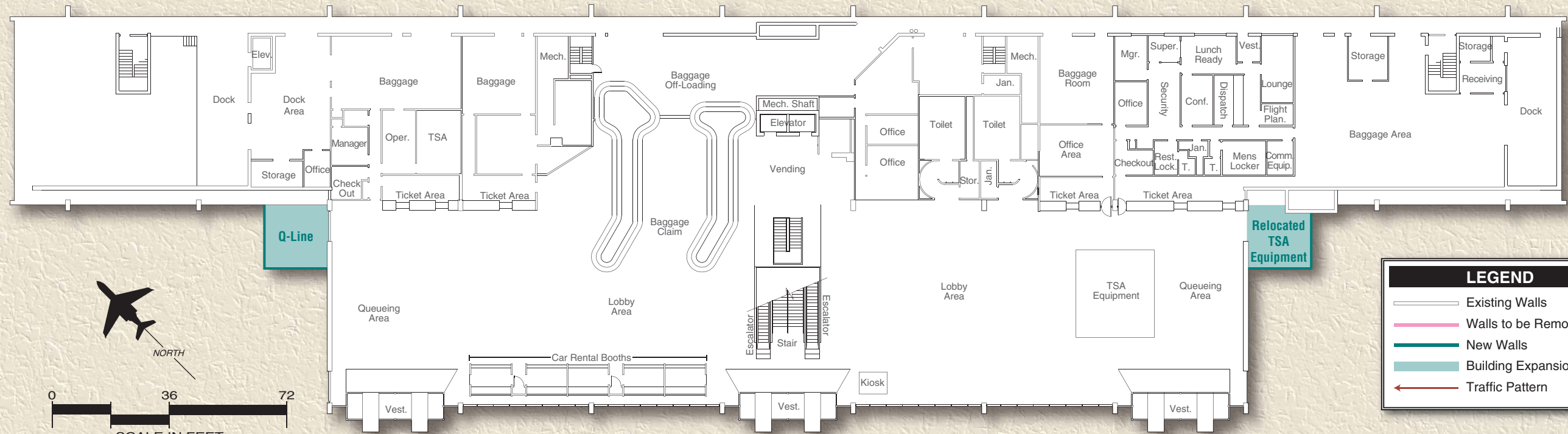

| LEGEND | |
|--------|---------------------|
| | Existing Walls |
| | Walls to be Removed |
| | New Walls |
| | Building Expansion |
| | Traffic Pattern |

that optimizes facility location and efficiency. All general aviation facilities are located on the east side of the airport facing Runway 17-35. Larger, high activity conventional hangars are centrally located on the east ramp. T-hangars are grouped together and are set back from the ramp. Box hangars are also grouped together and are set back and to the sides of the conventional hangars.

Exhibit 4M identifies those locations where future general aviation facilities may be located. There is space available for three large conventional hangars. Any of the existing airport businesses could choose to build these hangars as their businesses expand, or these locations could be developed by new airport operators.

The area to the immediate northeast of the general aviation apron was previously identified for corporate parcel development. Two new hangars have been constructed in this area since the previous master plan. The development of corporate parcels by private entities is a popular method of securing airport facilities. Developers can enter into a long term land lease with the airport and then build custom hangar facilities. This corporate parcel concept from the previous master plan is continued in this alternative.

Although the facility layout presented in **Exhibit 4M** will adequately meet forecast growth in general aviation demand by owners of based aircraft, it is difficult to forecast the needs of aviation-related businesses. With Duncan Aviation, in particular, the airport has proved that it can support large aviation-related businesses. Be-

cause of this track record, it is prudent to identify any airport property that may be utilized if Duncan Aviation were to expand dramatically or if another large aviation-related employer were to locate at the airport.

The area between Runway 17-35 and Runway 14-32 is approximately 145 acres. **Exhibit 4N** presents one possible alternative to develop a portion of this area. The alternative presented provides space for large conventional hangars, corporate parcels, and T-hangars facing Runway 17-35. Opposite this general aviation development are large aviation-related parcels facing Runway 18-36. These large parcels may be utilized by any aviation-related business needing substantial flight line space. This facility layout would typically meet the needs of general aviation and business expansion, but any final plans should address the specific needs of developers.

AVIATION SUPPORT FACILITIES

Aviation support facilities are those functions that do not logically fall into airside or landside classification. Facilities such as aircraft rescue and firefighting, airport maintenance, and fuel farms are essential to maintaining a safe and efficient operating environment.

Airport Rescue and Firefighting Facility (ARFF)

At the time of the previous master plan in 1998, the Lincoln Airport Authority and the Nebraska Air National Guard (NEANG) maintained separate

ARFF services. Since then, the ARFF functions have been combined into the single facility and is operated and staffed by the NEANG.

This arrangement has eliminated the duplication of ARFF functions and has worked efficiently. The ARFF facility has adequate equipment to serve both civilian and military needs. The existing capability meets Index B requirements.

For certification purposes, ARFF vehicles must demonstrate an emergency response time of three minutes or less to a simulated accident. At Lincoln Airport, the ARFF vehicles must get to the intersection of Runway 18-36 and Runway 14-32. Currently, the ARFF team meets this requirement but the response time may be improved with better access from the ARFF station to the taxiway. Under the current situation, the ARFF vehicles must nearly come to a stop in order to turn right onto Taxiway D. An alternative access point to Taxiway D will be provided in the recommended master plan concept.

Fuel Storage

The primary fuel farm is located south of the general aviation ramp. Additional fuel capacity needs will be determined by the FBOs that own and maintain the fuel farm. As the number of commercial flights, in particular, increase, there may be a need for additional fuel storage capability. Land area to the immediate south of the existing fuel farm has been identified to accommodate potential expansion.

Air Cargo Facilities

The air cargo facility is currently located to the immediate south of the terminal building and it fronts the terminal area apron. This facility is adequate to meet forecast air cargo demands. In the event that a new airport business, such as one that could locate in the Lincoln Air Park Rail Center, generates substantial air cargo activity, the location of the existing facility may not be ideal and the size be constrained. In either event, a west side air cargo facility should be planned.

The previous master plan located a new air cargo facility on the southwest ramp area. This location is considered feasible, but if it is Rail Center tenants that generate the need for expanded air cargo facilities then consideration should be given to locating a new cargo facility in the northwest area of the west ramp. Having air cargo facilities on the same side of the airfield as the business and industry that is likely to generate air cargo activity helps improve logistics and better accommodates “just-in-time” operational needs. **Exhibit 4P** presents two northwest air cargo facility locations in addition to the southwest ramp location from the previous master plan.

Maintenance Facilities

The airport maintenance buildings are located on the west ramp and have direct access to all airside facilities. The largest of these buildings is approximately 44,000 square feet, and the second largest is approximately 24,000



Fuel Farm Expansion





North Park Road

Aviation Road

Taxiway A

TAXI ONLY

LEGEND

-  Airport Property Line
-  Ultimate Roads / Parking
-  Ultimate Pavement
-  Ultimate Building

 NORTH

0 200 400

SCALE IN FEET

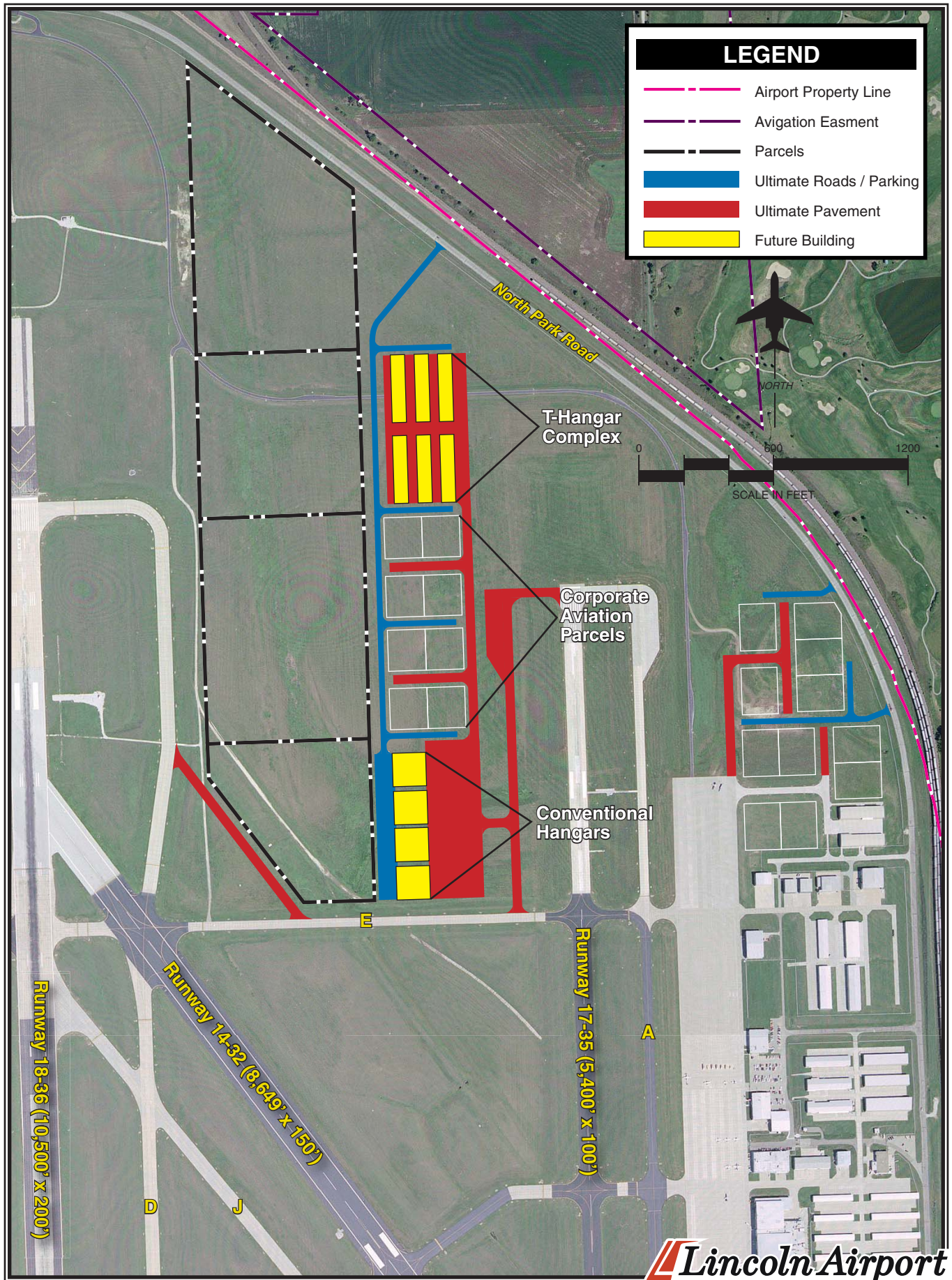

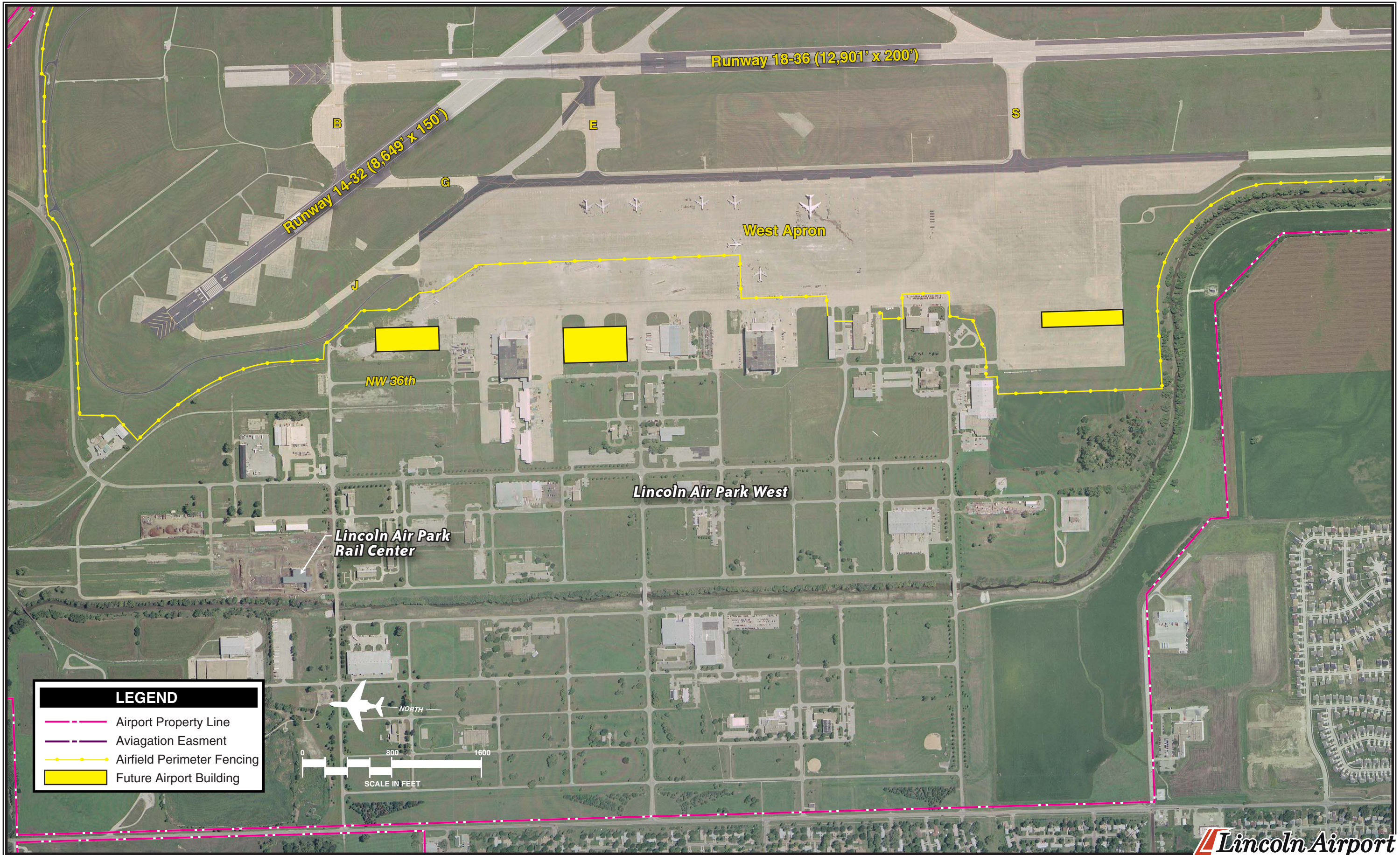

square feet. These buildings are adequate in size and should be maintained in the future.

SUMMARY

This airfield alternatives discussion has focused on those areas that are in need of planning attention. All non-standard conditions on the airfield have been addressed. The “hot spots” identified by the FAA have also been addressed. It should be noted that “hot spots” are not inherently unsafe, but where opportunities exist to make these areas more defined for pilots appropriate alternatives have been presented.

Landside facility development necessary to meet forecast growth in aviation activity has focused on locating general aviation facilities. The passenger terminal building appears adequate at this time, but the Lincoln Airport Authority should be aware of any internal remodeling that can be undertaken to increase passenger comfort.

The remaining chapters will be dedicated to refining the basic concept into a final plan with recommendations to ensure proper implementation and timing for a demand-based program.

RECOMMENDED MASTER PLAN CONCEPT

Lincoln Airport

RECOMMENDED MASTER PLAN CONCEPT

The airport master planning process for the Lincoln Airport (LNK) has evolved through the development of forecasts of future demand, an assessment of future facility needs, and the evaluation of airport development alternatives to meet those future facility needs. The planning process has included the development of three sets of working papers, which were presented to the Planning Advisory Committee (PAC) and discussed at several coordination meetings. The Lincoln Airport Authority has also been represented in each of these meetings.

The PAC is comprised of several constituencies with an investment or interest in the Lincoln Airport. Groups represented on the PAC include the Federal Aviation

Administration (FAA), the Nebraska Department of Aeronautics (NDA), the City of Lincoln - public works and planning, the Lancaster County planning department, the Lincoln Chamber of Commerce, airport management, airport traffic control tower personnel, airport fixed base operators (FBOs), pilot associations, airlines, the Nebraska Air National Guard, and the Nebraska Army National Guard. This diverse group has provided extremely valuable input into this recommended plan.

In the previous chapter, several development alternatives were analyzed to explore options for the future growth and development of Lincoln Airport. The development alternatives were refined into a single recommended concept for the master plan. This chapter



describes, in narrative and graphic form, the recommended future use and development of Lincoln Airport.

RECOMMENDED MASTER PLAN CONCEPT

The recommended master plan concept, as presented on **Exhibit 5A**, presents an ultimate configuration for the airport that meets FAA design standards, increases overall airport capacity, and provides a variety of aircraft storage options. A phased program to implement the recommended development configuration will be presented in Chapter Six - Capital Program. The following subsections will describe the recommended master plan concept in detail.

AIRFIELD DESIGN STANDARDS

The FAA has established design criteria to define the physical dimensions of runways and taxiways, as well as the imaginary surfaces surrounding them, which protect the safe operation of aircraft at the airport. These design standards also define the separation criteria for the placement of landside facilities.

As discussed previously, FAA design criteria primarily center on the airport's critical design aircraft. The critical aircraft is the most demanding aircraft or family of aircraft which currently, or are projected to, conduct 500 or more operations (take-offs or landings) per year at the airport. Often the critical aircraft can also be determined by the largest commercial aircraft with regularly scheduled service to the airport. Factors included in airport design are

an aircraft's wingspan, approach speed, and tail height coupled, with the instrument approach visibility minimums for each runway. The FAA has established the Airport Reference Code (ARC) to relate these critical aircraft factors to airfield design standards.

Analysis conducted in Chapter Three - Facility Requirements, concluded that the current critical aircraft is defined by the MD-80, a commercial service aircraft which falls in ARC C-III. The future critical aircraft for planning falls in ARC D-IV. This category of aircraft include: the B-757, B-767, and DC-10. In the recent past, these aircraft were utilized for commercial service operations at the airport. The master plan allows for the possibility that these larger commercial aircraft will operate with greater frequency. Since the airfield currently meets D-IV design standards, this standard should be maintained in order to meet forecast future demand.

The Nebraska Air National Guard 155th Air Refueling Wing maintains nine KC-135 refueling tanker aircraft at the airport. Although design of civil airports cannot be based on the needs of the military, it should be noted that the KC-135 is the tanker version of the civilian Boeing 707 which falls in ARC C/D-IV.

It is not necessary to design all airfield and landside elements to the same design standards. Varying design standards can be applied to runways and taxiways based on the role of the runway and the aircraft that frequently use that runway or taxiway. Runway 17-35, for example, is closest to the general

04MP20_3E-2/22/06

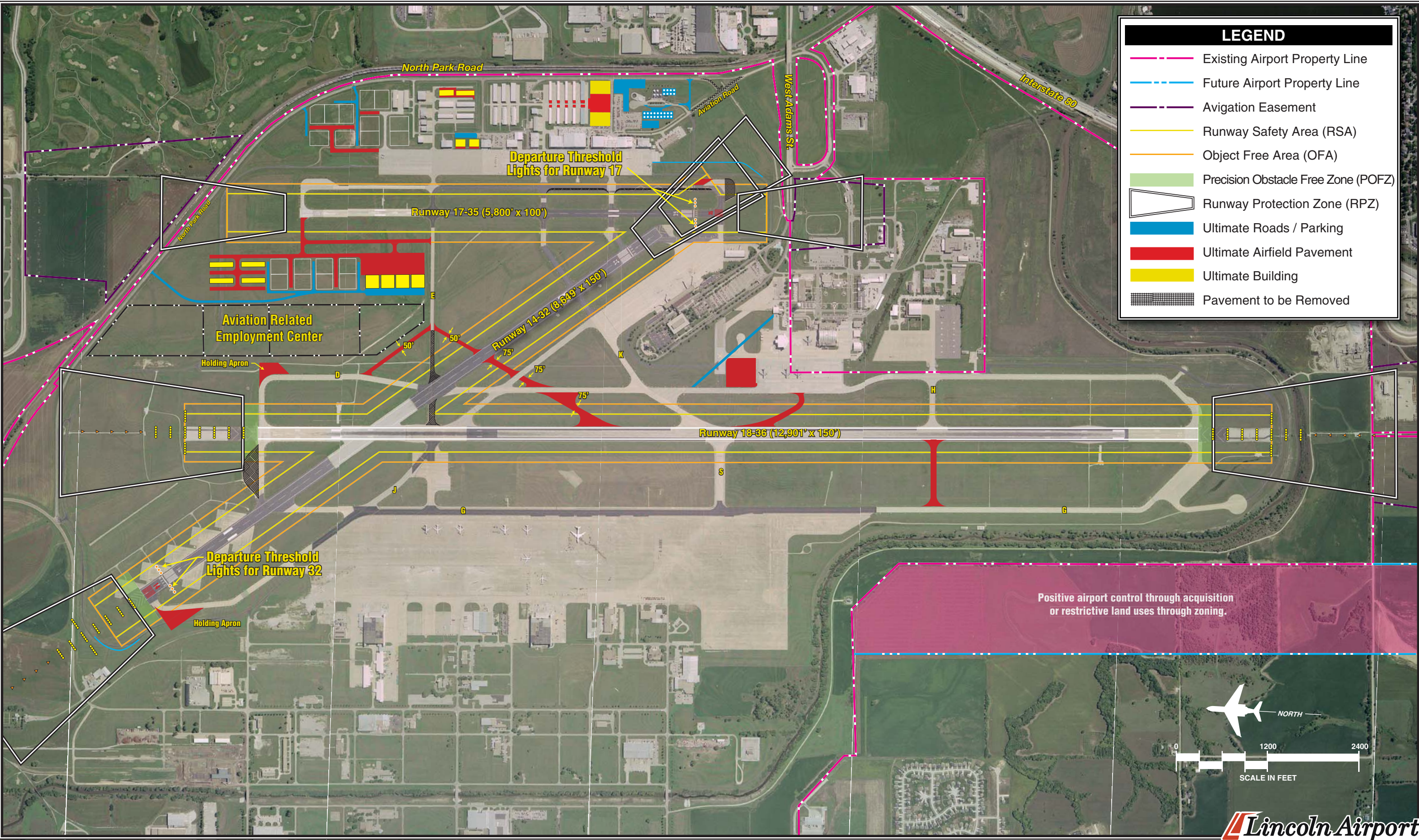

LEGEND

- Existing Airport Property Line
- Future Airport Property Line
- Avigation Easement
- Runway Safety Area (RSA)
- Object Free Area (OFA)
- Precision Obstacle Free Zone (POFZ)
- Runway Protection Zone (RPZ)
- Ultimate Roads / Parking
- Ultimate Airfield Pavement
- Ultimate Building
- Pavement to be Removed

Positive airport control through acquisition or restrictive land uses through zoning.

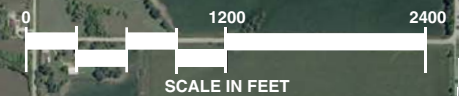

aviation services provided on the east ramp and, thus, should be designed to accommodate general aviation aircraft anticipated to utilize those services. Runways 18-36 and 14-32, however, are utilized by commercial aircraft and should meet the corresponding design standards.

Table 5A summarizes the airport design standards to be applied to the ultimate design of Lincoln Airport.

AIRSIDE RECOMMENDATIONS

Airside development is typically defined as those elements related to the runway and taxiway system. Runway 18-36 is currently 200 feet wide and 12,901 feet long. Both of these dimensions exceed FAA design standards for the previously determined critical aircraft for the airport, which falls in airport reference code (ARC) D-IV. The critical aircraft is the same as in the previous airport layout plan (ALP) as approved by the FAA.

The width of the runway is planned to be reduced to 150 feet. The remaining 25 feet on each side of the runway would remain in place and be utilized as runway shoulder. The runway edge lights would then be relocated to the appropriate distance considering the new runway width. Reduction of the runway width is being proposed as only 150 feet of runway width is eligible for FAA grants-in-aid for runway maintenance and reconstruction, when necessary. This recommendation would fol-

low Option C from Exhibit 4C presented in the previous chapter.

The length of the runway is planned to remain at its current dimension, although only 10,500 feet of runway length was deemed necessary to serve the current critical aircraft operating at the airport (MD-80). Extensive analysis in Chapter Four – Alternatives, indicated that the cost to reduce the runway length by removing unnecessary pavement and relocating navigational aids far exceeded the cost of maintaining the current runway length over the next 20 years.

Crosswind Runway 14-32 is planned for improvements that take into consideration changes in FAA design standards implemented for the runway safety area (RSA) since the previous master plan. Previously, the RSA for Runway 14-32 needed to extend 1,000 feet beyond both runway ends. Now, only 600 feet of RSA needs to be provided prior to landing. The 1,000-foot RSA standard is still required on the far end of the runway for both arrivals and departures.

The landing threshold for Runway 14 is planned to be relocated back to the northern pavement end. This will provide more landing length for Runway 14 than currently exists. The landing threshold for Runway 32 is planned to remain in its current location. Declared distances would continue to be employed on this runway as presented in **Table 5B**.

**TABLE 5A
Airfield Planning Design Standards (Ultimate)
Lincoln Airport**

| DESIGN STANDARDS | | | | | | |
|---|-------------|-------------|--------------|--------------------------|-------------|---------------|
| Airport Reference Code (ARC) | D-IV | D-IV | C-III | C-III | D-II | D-II |
| Lowest Visibility Minimum | ½ Mile | ½ Mile | 1 Mile/VFR | ½ Mile/ 1 Mile | 1 Mile/VFR | 1 Mile |
| Runways | | | | | | |
| Length (ft.) | 12,901 | 12,901 | 8,649 | 8,649 | 5,400 | 5,800 |
| Width (ft.) | 200 | 150 | 150 | 150 | 100 | 100 |
| Pavement Strength (lbs.) | | | | | | |
| Single Wheel Loading (SWL) | 100,000 | 100,000 | 80,000 | 80,000 | 49,000 | 60,000 |
| Dual Wheel Loading (DWL) | 200,000 | 200,000 | 170,000 | 170,000 | 60,000 | 90,000 |
| Double Tandem (DTWL) | 400,000 | 400,000 | 280,000 | 280,000 | NA | NA |
| Shoulder Width (ft.) | 25 | 25 | 20 | 20 | 10 | 10 |
| Runway Safety Area | | | | | | |
| Width (ft.) | 500 | 500 | 500 | 500 | 500 | 500 |
| Length Beyond Runway End (ft.) | 1,000 | 1,000 | 1,000 | 1,000 | 1,000 | 1,000 |
| Length Prior to Landing (ft.) | 600 | 600 | 600 | 600 | 600 | 600 |
| Object Free Area | | | | | | |
| Width (ft.) | 800 | 800 | 800 | 800 | 800 | 800 |
| Length Beyond Runway End (ft.) | 1,000 | 1,000 | 1,000 | 1,000 | 1,000 | 1,000 |
| Obstacle Free Zone | | | | | | |
| Width (ft.) | 400 | 400 | 400 | 400 | 400 | 400 |
| Length Beyond Runway End (ft.) | 200 | 200 | 200 | 200 | 200 | 200 |
| Taxiways | | | | | | |
| Width (ft.) | 75 | 75 | 50 | 50 | 35/50 | 35/50 |
| OFA (ft.) | 259 | 259 | 186 | 186 | 131 | 131 |
| Centerline to Fixed or Movable Object (ft.) | 129.5 | 129.5 | 93 | 93 | 65.5 | 65.5 |
| Runway Centerline to: | | | | | | |
| Parallel Taxiway Centerline (ft.) | 400 | 400 | 300 | 300/400 | 300 | 300 |
| Aircraft Parking Area (ft.) | 500 | 500 | 400 | 400/500 | 400 | 400 |
| Building Restriction Line (ft.) | | | | | | |
| 20 ft. Height Clearance | 640 | 640 | 640 | 640 | 640 | 640 |
| 35 ft. Height Clearance | 745 | 745 | 745 | 745 | 745 | 745 |
| Runway Protection Zones | | | | | | |
| Inner Width (ft.) | 1,000 | 1,000 | 500 | 1,000/500 | 500 | 500 |
| Outer Width (ft.) | 1,750 | 1,750 | 700 | 1,750/700 | 1,700 | 1,700 |
| Length (ft.) | 2,500 | 2,500 | 1,010 | 2,500/1,010 | 1,010 | 1,010 |
| Approach Slope (Threshold Siting Surface) | 34:1 | 34:1 | 20:1 | 34:1/20:1 | 20:1 | 20:1 |
| Approach Slope (Part 77) | 50:1 | 50:1 | 34:1/20:1 | 50:1 | 34:1/20:1 | 34:1 |
| Departure Surface | 40:1 | 40:1 | 40:1 | 40:1 | 40:1 | 40:1 |
| One-Engine Inoperable (OEI) Surface | 62.5:1 | 62.5:1 | 62.5:1 | 62.5:1 | NA | NA |

Bold = Airfield Design Changes

Source: FAA Advisory Circular 150/5300-13, Airport Design, Change 10

TABLE 5B
Declared Distances for Runway 14-32
Lincoln Airport

| | Existing Declared Distances | | Ultimate Declared Distances | |
|------|-----------------------------|-----------|-----------------------------|-----------|
| | Runway 14 | Runway 32 | Runway 14 | Runway 32 |
| ASDA | 8,649 | 8,286 | 8,649 | 8,286 |
| LDA | 8,286 | 7,816 | 8,649 | 7,816 |

ASDA: Accelerate-stop distance available
 LDA: Landing distance available
 All distances are in feet

Both ends of Runway 14-32 are considered for improved instrument approaches. Runway 14 is planned for a Category I (CAT I) approach with visibility minimums not lower than ½-mile and cloud ceilings of 200 feet. This sophisticated approach will require the installation of a medium intensity approach lighting system with runway alignment indicator lights (MALSR). This type of approach currently requires glideslope and localizer antennas; however, GPS may be capable of providing CAT I minimums in the near future. It is important that this type of approach is implemented prior to Runway 18-36 being closed due to reconstruction or long term maintenance. Runway 32, which does not currently support instrument approaches, is planned for a GPS approach with one mile visibility minimums.

Runway 17-35 is also planned for improvements. First, the current threshold to Runway 35 is planned to be relocated approximately 400 feet to the south end of the pavement. This can be accomplished because the new RSA standard calls for only 600 feet prior to landing. As 1,000 feet of RSA is still needed on the far end of the runway for take-off, the current departure thresh-

old lights for Runway 17 can remain in place.

There are several reasons for relocating the Runway 35 landing threshold to the pavement end. First, previous analysis indicated that a length of 6,500 feet would be ideal to accommodate business jet aircraft up to the Gulfstream V. It was determined that the roads to the north and south of the runway constrain the airport authority from extending the runway. As a result, the maximum pavement gain achievable would be through the relocation of the Runway 35 landing threshold.

The second reason is to “clean up” the pavement configuration in that area. It is unusual and potentially confusing to pilots to have a lead-in taxiway to a relocated landing threshold. By moving the landing threshold to Runway 35 south 400 feet, a more common layout where the taxiways meet at the end of the runway can be achieved. Relocating the landing threshold may also reduce pilot confusion between Runway 35 and Taxiway A.

Runway 17-35 is also considered for improved instrument approaches. The existing GPS approach to Runway 17 is

adequate and planned to remain. Runway 35 is considered for a similar GPS approach providing one mile visibility minimums.

Several taxiway improvements are considered in the recommended master plan concept. The most important of these is a new taxiway extending from Taxiway E to Taxiway D. This taxiway will allow aircraft to travel from the east ramp to Runway 18 without entering Runway 14-32. This taxiway will reduce the potential for runway incursions in this area.

A second planned taxiway would extend between Runway 36 and Taxiway E. This taxiway is strategically located to improve overall runway capacity. The portion of the taxiway between Runway 18-36 and Taxiway D would serve as a high-speed exit taxiway. Its extension would serve as a connecting taxiway intended to improve efficiency. It has been extended to Taxiway E to improve the efficiency of moving aircraft from Runway 18-36 to the east ramp.

The development of both these taxiways will alleviate the airfield “Hot Spot” on Taxiway E between Runway 14-32 and Runway 18-36. This space is very constrained, only about 40 feet, and pilots must cross one hold line in order to get to the hold line where they are required to stop prior to entering Runway 18-36. Clearly, this is a confusing configuration and can lead to runway incursions. Once these taxiways are constructed, air traffic personnel can move aircraft around this “Hot Spot.” Since this portion of Taxiway E may not be necessary at all, the recommended concept calls

for removal of the pavement as depicted on **Exhibit 5A**.

A second capacity-relieving taxiway from Runway 18-36 is planned to the south of Taxiway K. The taxiway exit depicted is a “spiral” taxiway, which will allow aircraft landing on Runway 18 to exit at a slightly higher rate of speed than a more traditional 90 degree exit. The spiral at the end of this exit serves two purposes. The first is to direct aircraft back toward the terminal area via Taxiway D. The second is to prevent direct high speed access into the Air National Guard facilities.

The last planned taxiway will connect from Runway 18-36 to Taxiway G to the west at the location of Taxiway H. This taxiway would only become necessary when activity on the west ramp increases significantly.

The master plan concept calls for reducing the width of the southern 2,300 feet of Taxiway A from 75 feet to 50 feet to meet FAA design standards. Reducing the width of Taxiway A should also help alleviate the confusion some pilots have in differentiating between Runway 35 and Taxiway A.

Several changes to the holding apron layout are considered. First, new holding aprons are considered for the north end of Taxiway J and Taxiway D. The hold apron at the south end of Taxiway A is also expanded. That portion of the hold apron on the south end of Taxiway A that extends beyond the runway threshold is planned for removal. The “bump-out” of Taxiway B between the Runway 18 threshold and Runway 14-32 is also considered for removal.

LANDSIDE PLANNING RECOMMENDATIONS

The primary goal of landside facility planning is to provide adequate aircraft storage space to meet the forecast need while also maximizing operational efficiencies and land uses. Achieving this goal yields a development scheme which separates aircraft activity levels while maximizing the airport's revenue potential. **Exhibit 5A** depicts the recommended landside development plan for the airport.

In Chapter Two - Forecasts, based aircraft were forecast to increase from 181 to 240 through the 20-year planning scope. To accommodate this growth, additional storage facilities may be necessary. The landside facility layout at the airport has historically grouped similar activity levels when allowing hangar construction. For example, lower activity T-hangar structures are located in a complex, away from the flight line. Higher activity conventional hangars, typically utilized by FBOs, are located on the east apron, on the flight line. Medium activity box or corporate hangars are located to the side of the high activity conventional hangars.

The recommended concept continues this pattern by "in-filling" locations that are currently undeveloped. Space is available for two conventional hangars on the flight line facing the east ramp. These would be ideal for expansion of existing FBO facilities or the introduction of another specialty operator. Other "in-fill" includes two connected box hangar facilities to the immediate east of the new conventional hangars. To the northeast of the east ramp is an

area designated for private development of corporate aviation facilities.

To the immediate east of Duncan Aviation and south of the T-hangar complex is planned a ramp and two large conventional hangars. Access to this area is made through the T-hangar complex. These hangars would ideally be constructed by the existing FBO in order to maintain a continuity of facilities. These hangars would be located on the existing Duncan Aviation parking lot, thus new parking lots are planned to the south.

As increases in commercial activity occur, there may be a need to expand the fuel farm located southeast of the east ramp. A secondary fuel farm is depicted to the west which mirrors the existing fuel farm.

Surface access to the general aviation complex has also been improved. Currently, drivers are able to enter the Duncan complex at a high rate of speed. Those unfamiliar with the road layout could be confused when the road ends abruptly. To make the entrance to the Duncan complex safer, Aviation Road is planned to be closed at the intersection with North Park Road. This would require drivers to utilize North Park Road to access a new road, near the fuel farm, in order to access Duncan Aviation and the fuel farm area.

The area bounded by Taxiway E, Taxiway D, North Park Road, and Runway 17-35 encompasses approximately 145 acres. The master plan recommends reserving this area for aviation-related activity only. The eastern half is considered for extensive general aviation

development. This could occur if Duncan Aviation or another large maintenance FBO were to expand. The western half of the area is designated for an aviation-related employment center. This land use could include an aircraft manufacturer or a large aircraft maintenance facility.

Several on-airport roads are improved in the recommended master plan concept. The airport service road currently crosses a small portion of the Runway 14-32 object free area (OFA) to the northwest. **Exhibit 5A** shows the relocation of this road outside the OFA. The airport service road to the south and east of Taxiway A crosses the OFA associated with Runway 14-32 as well. This road is planned to be relocated in order to provide for an OFA that is free of objects.

The last on-airport road proposed is a diagonal service road leading from the Airport Rescue and Firefighting (ARFF) facility to Taxiway D. Currently, the ARFF response time to the intersection of Runway 18-36 and Runway 14-32 nearly exceeds the FAA minimum standard of three minutes. The tight turns that the ARFF personnel have to make in order to access Taxiway D have been cited as the primary reason for maximizing the response time. This diagonal road will certainly increase response times as the ARFF trucks will no longer have to come to a near stop to make the turn onto Taxiway D.

Adjacent to the existing Nebraska Air National Guard is space for ramp expansion. According to information from the Guard, there is a possibility of expanding the ramp, as depicted on the

exhibit, to accommodate at least two additional KC-135s. The construction of this ramp would be the responsibility of the Guard.

The Lincoln Airport Authority has been proactive in protecting the airport from encroachment by residential housing or other incompatible land uses. All the runway protection zones (RPZs) are either owned outright by the airport or the airport owns avigation easements. The parcel southwest of the airport, depicted on **Exhibit 5A**, encompasses approximately 256 acres. This area should be protected from encroachment. The airport could either purchase this property or restrictive zoning could be put in place. For purposes of this master plan, fee simple purchase will be considered.

TERMINAL BUILDING RECOMMENDATIONS

The airport terminal building is in excellent condition and has served the community for more than 30 years. The terminal building provides adequate space for most major functions of the airport. Since the events of 9/11, the needs of security screening personnel have increased. Addressing these needs is the highest priority for terminal building improvements.

Immediately after 9/11, Transportation Security Administration (TSA) bag screening took place in the main lobby area in front of the ticketing counters. This location was not ideal, as much needed lobby and queuing space was no longer available for the airline ticket counters. The baggage screening that

was located in front of Northwest Airlink/Pinnacle Airlines has since been relocated to behind the counters in the baggage preparation area. The TSA bag screening in front of the United and Allegiant counters currently remains in the lobby area.

The recommended master plan concept calls for an addition to the terminal building that would house the TSA baggage screening functions. It is recommended that this addition, approximately 300 square feet, be constructed in such a fashion to accommodate a second floor. The second floor would then be utilized by TSA passenger screening functions on the second floor. This space could be utilized as the line-queue in order to reduce congestion on the second floor while passengers wait to pass through security. This building addition is also mirrored on the north side of the building.

As the airport grows in enplanements, a need will develop for more space in the secure hold areas on the second floor. The terminal building concept plans for expansion of the hold area and passenger screening functions on each end of the building as previously depicted on Exhibit 4L. These additions will help reduce the congestion of enplaning and deplaning passengers that occurs on the

second floor by moving the TSA functions further away from the central second floor corridor.

SUMMARY

The recommended master plan concept has been developed in conjunction with the Planning Advisory Committee, airport management, and various airport stakeholders, and is designed to assist in making decisions on future development and growth of Lincoln Airport. This plan provides the necessary development to accommodate and satisfy the anticipated growth over the next 20 years and beyond.

Flexibility will be very important to future development at the airport. Activity projected over the next 20 years may not occur as predicted. The plan has attempted to consider demands that may be placed on the airport even beyond the 20-year planning horizon to ensure that the facility will be capable of handling a wide range of circumstances. The recommended plan provides the airport stakeholders with a general guide that, if followed, can maintain the airport's long term viability and allow the airport to continue to provide air transportation service to the region.

CAPITAL IMPROVEMENT PLAN

Lincoln Airport

CAPITAL IMPROVEMENT PLAN

The analyses completed in previous chapters evaluated development needs at the airport over the next 20 years and beyond, based on forecast activity and operational efficiency. The next step is the development of a capital improvement plan. The capital improvement plan is developed under the assumption that various demand based indicators, such as annual operations, annual passenger enplanements, and based aircraft grow as forecast. Since forecasts rarely follow a straight line growth pattern, attention should be placed on growth trends, and facility development should only follow demand that has materialized.

The presentation of the capital improvement plan is organized into two sections. The first is the airport development schedule and cost summaries which are presented in graphic and narrative form. The second is a discussion on the various

capital improvement funding sources on the federal, state, and local levels.

AIRPORT DEVELOPMENT SCHEDULES AND COST SUMMARIES

Now that the specific needs and improvements for the airport have been established, the next step is to determine a realistic schedule and the associated costs for implementing the plan. This section will examine the overall cost of each item in the development plan and present a development schedule. A short term capital improvement plan, programmed by years, has been developed to cover the first five years of the plan. The remaining projects will be grouped into intermediate (years 6-10) and long (years 11-20) term planning horizons. By utilizing planning horizons instead of specific years for intermediate and long term development, the airport

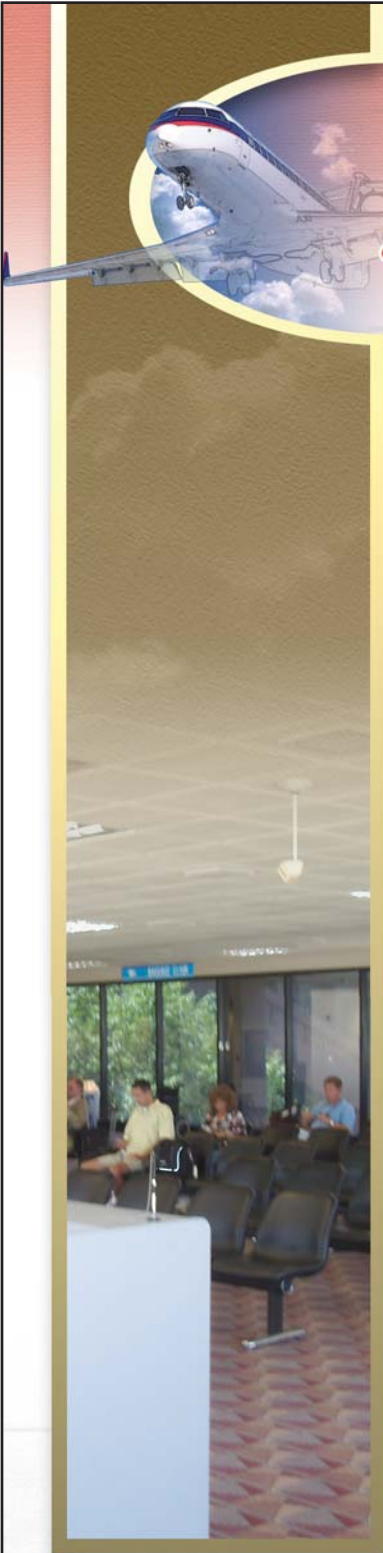

will have greater flexibility to adjust capital needs as demand dictates. **Table 6A** summarizes the key mile-

stones for each of the three planning horizons.

| TABLE 6A Planning Horizon Milestone Summary Lincoln Airport | | | | |
|--|------------------|--------------------------|-------------|-------------|
| | BASE YEAR | PLANNING HORIZONS | | |
| | 2005 | 2010 | 2015 | 2025 |
| Air Carrier Activity | | | | |
| Enplaned Passengers | 202,917 | 252,000 | 281,000 | 351,000 |
| Annual Operations | 12,645 | 13,534 | 14,085 | 15,918 |
| General Aviation Activity | | | | |
| Based Aircraft | 181 | 200 | 215 | 240 |
| Annual Operations | | | | |
| Itinerant | 31,097 | 36,000 | 44,000 | 59,000 |
| Local | 8,481 | 13,000 | 22,000 | 46,000 |
| <i>Total General Aviation Operations</i> | 39,578 | 49,000 | 66,000 | 105,000 |
| Other Air Taxi Activity | 5,629 | 7,190 | 8,231 | 10,505 |
| Military Activity | | | | |
| Itinerant | 13,331 | 15,000 | 15,000 | 15,000 |
| Local | 5,494 | 7,500 | 7,500 | 7,500 |
| <i>Total Military Operations</i> | 18,825 | 22,500 | 22,500 | 22,500 |
| Total Airport Operations | 76,677 | 92,224 | 110,816 | 153,923 |
| Annual Instrument Approaches | 623 | 1,605 | 1,918 | 2,659 |

A key aspect of this planning document is the use of demand-based planning milestones. The short term planning horizon contains items of highest need and/or priority. These items should be considered for development based on actual demand levels within the next five years. As short term horizon activity levels are reached, it will then be time to program for the intermediate term based upon the next activity milestones. Similarly, when the intermediate term milestones are reached, it will be time to program for the long term activity milestones.

Most development items included in the recommended concept will need to follow demand indicators. For exam-

ple, the plan includes construction of new hangar aprons and taxilanes. Based aircraft will be the indicator for additional hangar needs. If based aircraft growth occurs as projected, additional hangars will need to be constructed to meet the demand. If growth slows or does not occur as projected, hangar pavement projects can be delayed. As a result, capital expenditures will be undertaken as needed, which leads to a responsible use of capital assets. Some development items do not depend on demand, such as pavement maintenance. These types of projects typically are associated with day-to-day operations and should be monitored and identified by airport management.

As a master plan is a conceptual document, implementation of these capital projects should only be undertaken after further refinement of their design and costs through architectural and engineering analyses. Moreover, some projects may require extensive infrastructure improvements. The capital plan addresses one possible solution to this concern, but any future development should include extensive analysis of the capacity of infrastructure to support the growth.

The cost estimates presented in this chapter have been increased to allow for contingencies that may arise on the project. Capital costs presented here should be viewed only as estimates subject to further refinement during design. Nevertheless, these estimates are considered sufficiently accurate for planning purposes. Cost estimates for each of the development projects listed in the capital improvement plan have been inflated to reflect the cost anticipated for the actual year of construction. **Exhibit 6A** presents the proposed capital program for Lincoln Airport (LNK). **Exhibit 6B** graphically presents the master plan projects on an aerial photograph of the airport.

SHORT TERM IMPROVEMENTS

Short term improvements are divided into yearly timeframes and are further prioritized based on the needs of the airport. To accomplish many of the short term projects in the year specified, certain steps may need to be taken prior to the year identified for construction. For example, certain

projects may require engineering design the year prior to implementation.

The first year of the capital improvement program (2009) focuses on addressing the ongoing confusion pilots may have distinguishing between the approach to Runway 35 and Taxiway A. As has been discussed in detail, several steps have been taken to alert pilots mistakenly lined up on Taxiway A, and not Runway 35. These have included the application of a large 800-foot long serpentine line and the words "TAXI ONLY" on Taxiway A.

The first project proposes shifting the Runway 35 landing threshold south 400 feet to the physical end of the pavement. By taking this action, Taxiway A will lead to the Runway 35 threshold at a perpendicular angle. This is a much more common pavement design rather than the current alignment of having 400 feet of taxiway leading to the Runway 35 threshold. In addition, relocation of the Runway 35 threshold will provide an additional 400 feet of landing and take-off length for Runway 35 (north flow operations).

The next project, also associated with the southern end of Runway 35, is the removal of the south Taxiway A hold apron that extends beyond the lateral edge of the runway threshold. A portion of the hold apron is planned to the immediate north of this hold apron in order to provide adequate room for aircraft run-up activities. In addition, Taxiway A is planned to be reduced to a uniform 50-foot width. The last project of the FY 2008 capital improvement program (CIP) is the relocation

of the airport service road to the immediate east of Runway 35. This service road currently penetrates the extended object free area (OFA) for Runway 14-32.

Fiscal year 2010 projects are primarily associated with improvements to the layout and design of Runway 14 including planning for improved instrument approaches. Runway 14-32 needs to provide similar approach capability to Runway 18-36 before Runway 18-36 is reconstructed and narrowed in the 2011 timeframe.

The first project in FY 2010 is to reclaim maximum operational runway length for Runway 14-32 by relocating the Runway 14 landing threshold to the pavement end. A reduction in FAA standards for runway safety area prior to landing from 1,000 feet to 600 feet makes the threshold relocation feasible. This will provide for an additional 363 feet of landing length to Runway 14. The next project programmed in FY 2010 is the installation of a medium intensity approach lighting system with runway alignment indicator lights (MALSR), on Runway 14. The MALSR is a minimum requirement for a CAT I GPS approach. This approach should be implemented prior to the closure of Runway 18-36 for reconstruction.

Two other projects are associated with the Runway 14-32 improvements in FY 2010. The first is a slight rerouting of the airport service road in order to remove it from the OFA. In addition, a hold apron on the northwest end of Taxiway J is also planned.

Only one project of significance is planned for FY 2011. This project is the construction of a connector taxiway between Taxiway E and Taxiway D. This taxiway will allow aircraft to taxi from the east ramp to the Runway 18 threshold without having to enter Runway 14-32. As a result, this project will reduce the potential for runway incursions.

The most significant project for fiscal year 2012 is the reconstruction and narrowing of Runway 18-36. In accordance with Option C, presented earlier on Exhibit 4C, the outer 50 to 75 feet of pavement is to be replaced with concrete and the outer 25-foot shoulders are planned to be reconstructed of asphalt. The ultimate runway width will be 150 feet constructed entirely of concrete with asphalt shoulders. The runway edge lights would be relocated into the asphalt shoulders. Prior to initiation of this project, Runway 14-32 needs to be fully capable of accommodating commercial aircraft with a CAT I approach.

A separate item associated with Runway 18-36 is the ongoing maintenance of the center 100-foot concrete keel section. While the runway is closed for the major narrowing and reconstruction project, routine maintenance should be undertaken on the keel section in order to reduce the overall time the runway is closed.

Expansion of the terminal building, primarily to accommodate TSA functions, is also considered in 2012. As previously depicted on Exhibit 4L, the proposed terminal building expansion

| Project Description | | Project Cost | FAA Eligible | Local Investment |
|-----------------------------------|---|---------------------|---------------------|---------------------|
| SHORT TERM PROJECTS | | | | |
| 2009 | | | | |
| 1 | Relocate Runway 35 Landing Threshold to Pavement End | \$510,000 | \$484,500 | \$25,500 |
| 2 | Add/Remove Taxiway A Width and Hold Apron | \$515,000 | \$489,250 | \$25,750 |
| 3 | Service Road Relocation (Runway 35 end) | \$545,000 | \$517,750 | \$27,250 |
| | SUBTOTAL | \$1,570,000 | \$1,491,500 | \$78,500 |
| 2010 | | | | |
| 4 | Relocate Runway 14 Landing Threshold to Pavement End | \$580,000 | \$551,000 | \$29,000 |
| 5 | Install MALSR on Runway 14 End | \$730,000 | \$693,500 | \$36,500 |
| 6 | Service Road Relocation (Runway 14 end) | \$330,000 | \$313,500 | \$16,500 |
| 7 | Construct Taxiway J Hold Apron | \$1,535,000 | \$1,458,250 | \$76,750 |
| | SUBTOTAL | \$3,175,000 | \$3,016,250 | \$158,750 |
| 2011 | | | | |
| 8 | Construct Connector Taxiway Between E and D | \$1,300,000 | \$1,235,500 | \$65,000 |
| | SUBTOTAL | \$1,300,000 | \$1,235,500 | \$65,000 |
| 2012 | | | | |
| 9 | Reconstruct and Narrow Runway 18-36 (Option C) | \$11,640,000 | \$11,058,000 | \$582,000 |
| 10 | Crack Repair Inner 100-foot Section of Runway 18-36 | \$700,000 | \$665,000 | \$35,000 |
| 11 | Terminal Building/TSA Improvements | \$410,000 | \$0 | \$410,000 |
| | SUBTOTAL | \$12,750,000 | \$11,723,000 | \$1,027,000 |
| 2013 | | | | |
| 12 | Construct T-Hangars (6 units) and Box Hangars (4 units) | \$2,655,000 | \$0 | \$2,655,000 |
| 13 | Construct Box Hangar Taxilanes - Phase 1 | \$250,000 | \$237,500 | \$12,500 |
| 14 | Construct ARFF Access Road | \$725,000 | \$688,750 | \$36,250 |
| | SUBTOTAL | \$3,630,000 | \$926,250 | \$2,703,750 |
| TOTAL SHORT TERM | | \$22,425,000 | \$18,392,000 | \$4,033,000 |
| INTERMEDIATE TERM PROJECTS | | | | |
| 1 | Construct Taxiway from Runway 18-36 to Taxiway E | \$5,405,000 | \$5,134,750 | \$270,250 |
| 2 | Remove Portions of Taxiway E | \$435,000 | \$413,250 | \$21,750 |
| 3 | Expand GA Employment Center Parking | \$975,000 | \$0 | \$975,000 |
| 4 | Construct GA Apron and Taxilane | \$1,755,000 | \$1,667,250 | \$87,750 |
| 5 | Construct GA Conventional Hangar - Phase 1 | \$5,940,000 | \$0 | \$5,940,000 |
| 6 | Acquire 256 Acres SW of Airport | \$5,500,000 | \$0 | \$5,500,000 |
| 7 | Pavement Maintenance | \$7,590,000 | \$7,210,500 | \$379,500 |
| TOTAL INTERMEDIATE TERM | | \$27,600,000 | \$14,425,750 | \$13,174,250 |
| LONG TERM PROJECTS | | | | |
| 1 | Construct Spiral Taxiway Exit from Runway 18-36 | \$2,265,000 | \$2,151,750 | \$113,250 |
| 2 | Construct Taxiway D Hold Apron | \$1,215,000 | \$1,154,250 | \$60,750 |
| 3 | Remove Taxiway B Hold Apron | \$358,500 | \$340,575 | \$17,925 |
| 4 | Construct GA Conventional Hangar - Phase 2 | \$7,910,000 | \$0 | \$7,910,000 |
| 5 | Construct GA Conventional Hangars (2) - Phase 3 | \$4,400,000 | \$0 | \$4,400,000 |
| 6 | Construct Box Hangar Taxilanes - Phase 2 | \$1,260,000 | \$1,197,000 | \$63,000 |
| 7 | Construct Taxiway H | \$2,715,000 | \$2,579,250 | \$135,750 |
| 8 | Reconfigure General Aviation Access Road | \$750,000 | \$0 | \$750,000 |
| 9 | Terminal Building Hold Room Expansion | \$1,400,000 | \$0 | \$1,400,000 |
| 10 | West Side Cargo Facility Construction (Not Pictured) | \$3,000,000 | \$0 | \$3,000,000 |
| 11 | Pavement Maintenance | \$10,210,000 | \$9,699,500 | \$510,500 |
| TOTAL LONG TERM | | \$35,483,500 | \$17,122,325 | \$18,361,175 |
| TOTAL PROGRAM COSTS | | \$85,508,500 | \$49,940,075 | \$35,568,425 |

04MP20-6B-4/3007

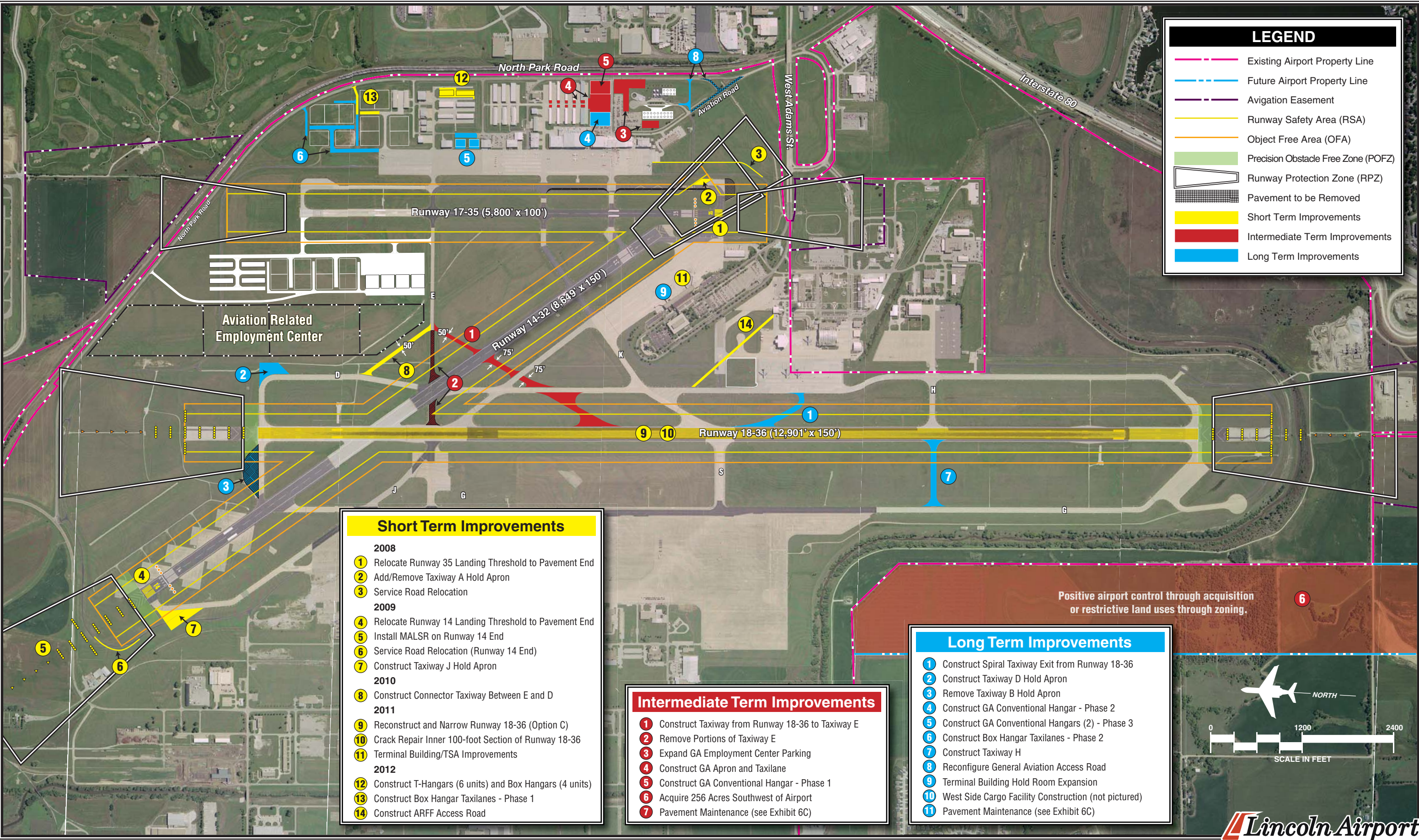

LEGEND

- Existing Airport Property Line
- Future Airport Property Line
- Avigation Easement
- Runway Safety Area (RSA)
- Object Free Area (OFA)
- Precision Obstacle Free Zone (POFZ)
- Runway Protection Zone (RPZ)
- Pavement to be Removed
- Short Term Improvements
- Intermediate Term Improvements
- Long Term Improvements

Short Term Improvements

2008

- 1 Relocate Runway 35 Landing Threshold to Pavement End
- 2 Add/Remove Taxiway A Hold Apron
- 3 Service Road Relocation

2009

- 4 Relocate Runway 14 Landing Threshold to Pavement End
- 5 Install MALSR on Runway 14 End
- 6 Service Road Relocation (Runway 14 End)
- 7 Construct Taxiway J Hold Apron

2010

- 8 Construct Connector Taxiway Between E and D

2011

- 9 Reconstruct and Narrow Runway 18-36 (Option C)
- 10 Crack Repair Inner 100-foot Section of Runway 18-36
- 11 Terminal Building/TSA Improvements

2012

- 12 Construct T-Hangars (6 units) and Box Hangars (4 units)
- 13 Construct Box Hangar Taxilanes - Phase 1
- 14 Construct ARFF Access Road

Intermediate Term Improvements

- 1 Construct Taxiway from Runway 18-36 to Taxiway E
- 2 Remove Portions of Taxiway E
- 3 Expand GA Employment Center Parking
- 4 Construct GA Apron and Taxilane
- 5 Construct GA Conventional Hangar - Phase 1
- 6 Acquire 256 Acres Southwest of Airport
- 7 Pavement Maintenance (see Exhibit 6C)

Long Term Improvements

- 1 Construct Spiral Taxiway Exit from Runway 18-36
- 2 Construct Taxiway D Hold Apron
- 3 Remove Taxiway B Hold Apron
- 4 Construct GA Conventional Hangar - Phase 2
- 5 Construct GA Conventional Hangars (2) - Phase 3
- 6 Construct Box Hangar Taxilanes - Phase 2
- 7 Construct Taxiway H
- 8 Reconfigure General Aviation Access Road
- 9 Terminal Building Hold Room Expansion
- 10 West Side Cargo Facility Construction (not pictured)
- 11 Pavement Maintenance (see Exhibit 6C)

Positive airport control through acquisition or restrictive land uses through zoning.

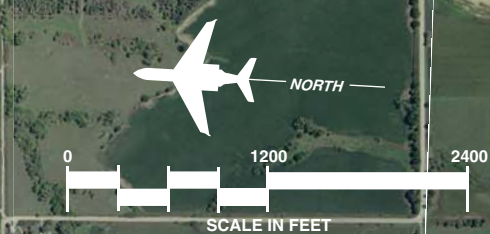

includes a 300-square-foot addition to the immediate north and south of the ticket counter areas. The south addition is the most critical as TSA bag screening currently takes place in the ticket queue line area. This addition should be engineered to accommodate a second floor which can then be used for the second floor TSA passenger screening activities. Although the south addition is an immediate need, the north addition may be shifted to a later timeframe unless there is an identified need for the additional space.

The final year of the short term planning horizon (FY 2013) identifies expansion of general aviation facilities as a need. If growth in based aircraft is realized, then a six unit T-hangar structure and a four-unit connected box hangar structure are planned. An access taxiway to the corporate aviation parcels to the northeast is also planned in this timeframe. It should be stressed that hangar development should only be undertaken if demand is evident. The final project of the short term is the construction of a dedicated aircraft rescue and fire-fighting access road to Taxiway D.

Short term improvements presented on Exhibit 6A and depicted on Exhibit 6B are estimated at \$22.43 million. The airport would be responsible for approximately \$4.03 million of that investment, while the remaining \$18.40 million is eligible for federal grant funding.

INTERMEDIATE TERM IMPROVEMENTS

As described previously, intermediate term projects approximately account for major airport needs currently projected for years six through ten of the CIP. The first project is the construction of a high-speed exit taxiway from Runway 18-36. This taxiway is planned to continue to Taxiway E. Once this taxiway is constructed, there is not a need for portions of Taxiway E. Removing portions of Taxiway E will reduce the potential for runway incursions at the intersection of Runways 14-32 and 18-36.

In anticipation of the expansion of the existing large aviation-related airport employer (Duncan Aviation), additional parking is planned south of the existing parking areas. These parking lots are planned for the east and west of the existing fuel farm with space reserved for fuel farm expansion, if needed. After the parking lots are constructed, a portion of the existing parking lot can be redeveloped for aviation-related uses. An apron area is planned with access available from the T-hangar area. One of two large conventional hangars is also planned for the intermediate timeframe.

The last project programmed in the intermediate planning horizon is the acquisition of 256 acres bordering the airport to the southwest. This acquisition is planned in order to protect the airport from possible encroachment from incompatible development.

Ongoing and routine pavement maintenance is an important consideration in the capital improvement program. The intermediate term CIP includes repair and rehabilitation of Runway 14-32, portions of Runway 18-36, and portions of Taxiways A, J, and G. The southwest portion of the main terminal apron is also identified for major concrete repair and subdrain improvements.

Projects included in the intermediate term have been estimated to cost \$27.60 million, of which the airport would be responsible for \$13.17 million in matching funds. The remaining \$14.43 is eligible for federal grant funding. The intermediate CIP is presented on both Exhibits 6A and 6C.

LONG TERM IMPROVEMENTS

The long term projects are those that may be necessary in years 11 through 20 of the master plan. The first project proposed is the spiral taxiway exit from Runway 18-36 near the National Guard facilities. This exit is strategically located to benefit airfield capacity by allowing aircraft landing Runway 18 to exit more rapidly than if they were exiting via a traditional right-angle exit. The next project is a hold apron on the north end of Taxiway D. Again, this is a capacity improvement and should be designed to accommodate large commercial airline aircraft. There is a portion of Taxiway B that is currently marked as unusable pavement. To prevent confusion, this pavement should be removed when financing allows.

The next several projects are directly related to expansion of general aviation facilities. A second large conventional hangar is planned east of Duncan Aviation. Two conventional hangars are planned for the open parking spaces that front the main general aviation apron. Extension of taxilanes into the corporate aviation parcels is also planned in this timeframe.

Construction of an extension of Taxiway G from Runway 18-36 to Taxiway G is planned for the long term. This project should only be undertaken if activity on the west ramp increases substantially. A redesign of the general aviation access roads, Aviation Road in particular, is also planned for the long term. As described previously, vehicular traffic can easily approach Duncan Aviation at high rates of speed. By developing a new Aviation Road entrance from North Park Road, vehicles will be forced to moderate their speed through the Duncan Aviation facilities.

The next long term capital project is expansion of the second floor terminal building holding rooms and passenger screening checkpoints. The last capital improvement project is the construction of a replacement air cargo facility on the west apron. The specific location of the cargo facility should be further evaluated at the time a need develops. Three potential locations were previously presented on Exhibit 4P.

In the ongoing effort to maintain the safety and adequacy of the existing pavement surfaces, an estimate of long term pavement maintenance costs has been included.

Total long term projects are estimated to require an investment of \$35.48 million. Of that total, the airport would be responsible for \$18.36 million while approximately \$17.12 million would be eligible for federal grants.

CAPITAL IMPROVEMENT SUMMARY

The capital improvement program is designed to first address any real or perceived safety issues on the airfield. For example, the first several projects relate to the relocation of the Runway 35 landing threshold to the pavement end. This action may help alleviate the confusion some pilots have differentiating between the runway and Taxiway A. The next few projects are designed to prepare the airport for an anticipated long term (several months) closure of Runway 18-36 for major reconstruction and rehabilitation. In order to close Runway 18-36 without a significant interruption in service to the airport, Runway 14-32 needs to be able to provide similar approach capability as Runway 18-36.

Through the intermediate and long term, a number of airfield projects are planned that will improve overall airfield capacity and reduce conflict points or "Hot Spots." For example, taxiway construction from Taxiway E to both Taxiway D to the north and Runway 18-36 to the south will reduce the potential for runway incursions.

Finally, several new hangar and apron areas are planned. The apron areas are typically eligible for federal grant

funding provided they are intended for public access. The hangars are typically not eligible for federal funding, thus the CIP shows the airport being responsible but private enterprise could also undertake the development of new hangar facilities.

The 20-year investment total is approximately \$85.51 million, with \$35.57 million of that total being the responsibility of the airport sponsor.

PAVEMENT MAINTENANCE

Maintaining existing usable pavements on the airfield is of critical importance for the airport. Over time, these surfaces will deteriorate due to heavy use and the impact of natural elements. High priority pavement maintenance projects that may be necessary are included as part of the CIP. This section will provide greater detail on those requirements.

Typically, concrete construction will have a 20-year useful life provided regular joint sealing and selective section replacement is undertaken. Asphalt construction will have a useful life of seven to ten years. Periodic milling, overlay, and sealing can extend the useful life.

Exhibit 6C presents those major pavement maintenance projects that will likely need to be undertaken within the 20-year scope of the master plan. **Table 6B** presents greater detail on the specific pavement maintenance needs and the associated cost estimate.

TABLE 6B**Major Pavement Maintenance Projects
Lincoln Airport**

| Project Number | Project Description | Planning Horizon | Estimated Cost |
|-----------------------------------|--|-------------------------|-----------------------|
| 1 | Minor Concrete Repair on Inner 100-foot Keel Section of Runway 18-36 (Joint and Panel Replacement) | Short | \$700,000 |
| SHORT TERM TOTAL | | | \$700,000 |
| 1 | Asphalt - Mill & Overlay Inner 100 feet of Runway 18-36 | Intermediate | \$600,000 |
| 2 | Asphalt - Seal Joints, Repair Pavement, and Rejuvenator Runway 14-32 | Intermediate | \$650,000 |
| 3 | Asphalt - Mill & Overlay Runway 17-35 (South Portion) | Intermediate | \$1,100,000 |
| 4 | Asphalt - Mill & Overlay Taxiway A (South Portion) | Intermediate | \$800,000 |
| 5 | Asphalt - Seal Joints, Repair Pavement, and Rejuvenator Taxiway G | Intermediate | \$200,000 |
| 6 | Asphalt - Seal Joints, Repair Pavement, and Rejuvenator Taxiway J | Intermediate | \$90,000 |
| 7 | Concrete - Remove and Replace Taxiway K (East Portion) | Intermediate | \$250,000 |
| 8 | Major Concrete Pavement Repair and Subdrains (Terminal Apron) | Intermediate | \$3,700,000 |
| 9 | Asphalt - Seal Joints, Repair Pavement, and Rejuvenator (Service Road) | Intermediate | \$200,000 |
| INTERMEDIATE TERM TOTAL | | | \$7,590,000 |
| 1 | Asphalt - Seal Joints, Repair Pavement, and Rejuvenator Runway 18-36 | Long | \$110,000 |
| 2 | Asphalt - Mill & Overlay Runway 14-32 | Long | \$5,500,000 |
| 3 | Asphalt - Seal Joints, Repair Pavement, and Rejuvenator Runway 17-35 (South Portion) | Long | \$250,000 |
| 4 | Asphalt - Seal Joints, Repair Pavement, and Rejuvenator Runway 17-35 (South Portion) | Long | \$200,000 |
| 5 | Asphalt - Mill & Overlay Taxiway G | Long | \$1,800,000 |
| 6 | Asphalt - Mill & Overlay Taxiway J | Long | \$750,000 |
| 7 | Asphalt - Mill & Overlay Service Road | Long | \$1,600,000 |
| LONG TERM TOTAL | | | \$10,210,000 |
| TOTAL PAVEMENT MAINTENANCE | | | \$18,500,000 |

Source: HWS Consulting Group

CAPITAL IMPROVEMENT FUNDING SOURCES

Financing capital improvements at the airport will not rely solely on the financial resources of the airport. Capital improvement funding is available through various grant-in-aid programs on both the state and federal levels.

The following discussion outlines key sources of funding potentially available for capital improvements at Lincoln Airport.

FEDERAL GRANTS

Through federal legislation over the years, various grant-in-aid programs

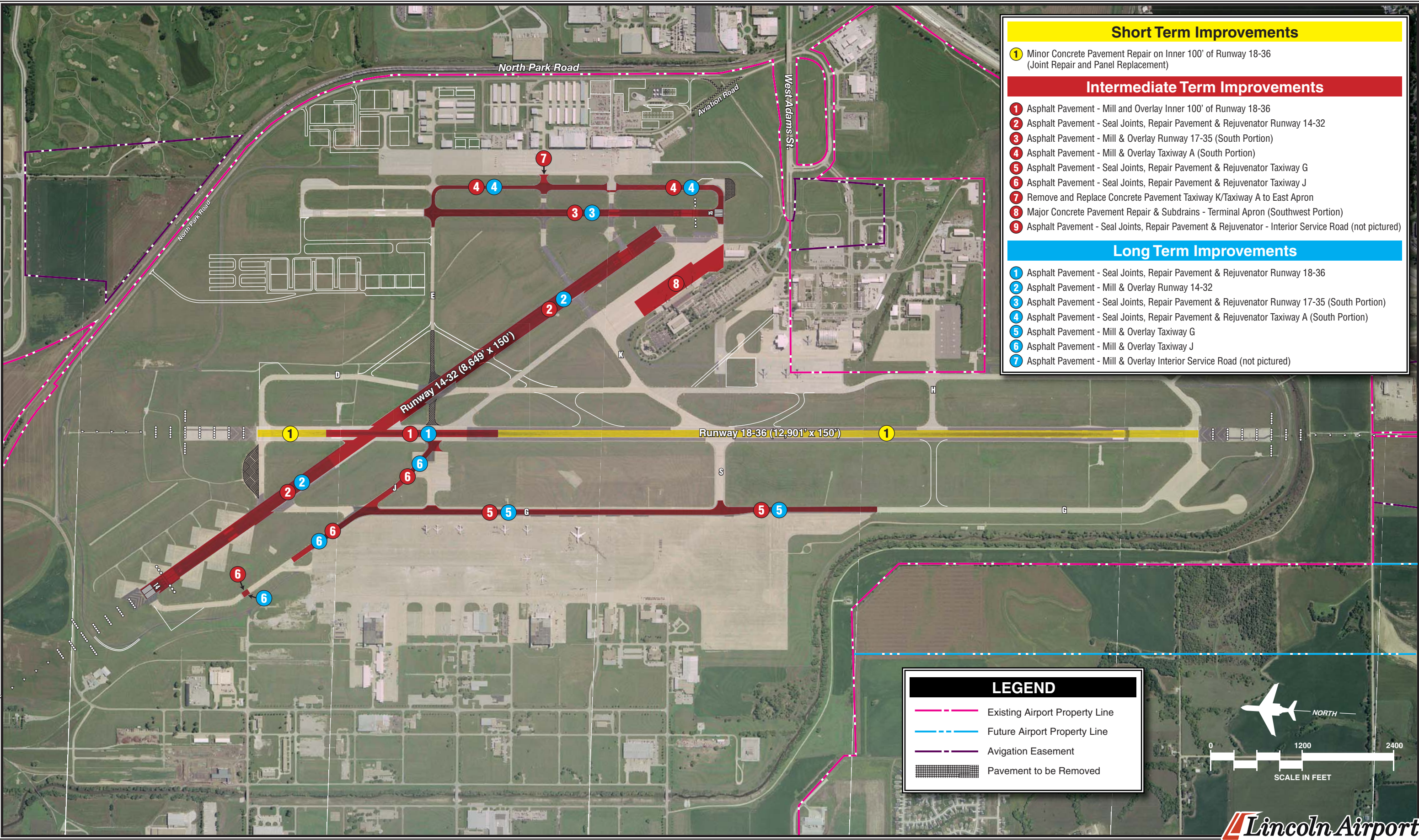

Short Term Improvements

- 1 Minor Concrete Pavement Repair on Inner 100' of Runway 18-36 (Joint Repair and Panel Replacement)

Intermediate Term Improvements

- 1 Asphalt Pavement - Mill and Overlay Inner 100' of Runway 18-36
- 2 Asphalt Pavement - Seal Joints, Repair Pavement & Rejuvenator Runway 14-32
- 3 Asphalt Pavement - Mill & Overlay Runway 17-35 (South Portion)
- 4 Asphalt Pavement - Mill & Overlay Taxiway A (South Portion)
- 5 Asphalt Pavement - Seal Joints, Repair Pavement & Rejuvenator Taxiway G
- 6 Asphalt Pavement - Seal Joints, Repair Pavement & Rejuvenator Taxiway J
- 7 Remove and Replace Concrete Pavement Taxiway K/Taxiway A to East Apron
- 8 Major Concrete Pavement Repair & Subdrains - Terminal Apron (Southwest Portion)
- 9 Asphalt Pavement - Seal Joints, Repair Pavement & Rejuvenator - Interior Service Road (not pictured)

Long Term Improvements

- 1 Asphalt Pavement - Seal Joints, Repair Pavement & Rejuvenator Runway 18-36
- 2 Asphalt Pavement - Mill & Overlay Runway 14-32
- 3 Asphalt Pavement - Seal Joints, Repair Pavement & Rejuvenator Runway 17-35 (South Portion)
- 4 Asphalt Pavement - Seal Joints, Repair Pavement & Rejuvenator Taxiway A (South Portion)
- 5 Asphalt Pavement - Mill & Overlay Taxiway G
- 6 Asphalt Pavement - Mill & Overlay Taxiway J
- 7 Asphalt Pavement - Mill & Overlay Interior Service Road (not pictured)

LEGEND

- Existing Airport Property Line
- Future Airport Property Line
- Avigation Easement
- Pavement to be Removed

NORTH

0 1200 2400

SCALE IN FEET

have been established to develop and maintain a system of public airports across the United States. The purpose of this system and its federally based funding is to maintain national defense and to promote interstate commerce. The most recent legislation affecting the federal funding was enacted in late 2003 and is titled, *Century of Aviation Re-authorization Act*, or *Vision 100*.

The four-year bill covers FAA fiscal years 2004, 2005, 2006, and 2007. This bill presented similar funding levels to the previous bill - *Air 21*. Airport Improvement Program (AIP) funding was authorized at \$3.4 billion in 2004, \$3.5 billion in 2005, \$3.6 billion in 2006, and \$3.7 billion in 2007. This bill provides the FAA the opportunity to plan for longer term projects versus one-year re-authorizations.

The source for *Vision 100* funds is the Aviation Trust Fund. The Aviation Trust Fund was established in 1970 to provide funding for aviation capital investment programs (aviation development, facilities and equipment, and research and development). The Aviation Trust Fund also finances the operation of the FAA. It is funded by user fees including taxes on airline tickets, aviation fuel, and various aircraft parts. The funds are distributed under appropriations set by Congress to airports in the United States which have certified eligibility. The distribution of grants is administered by the Federal Aviation Administration.

A portion of the annual distribution is to primary commercial service airports

based upon enplanement levels. Airports with qualifying levels of air cargo shipments can receive additional entitlements. After distribution of all designated funding entitlements, the remaining AIP funds are allocated by the FAA based upon the priority of the project for which they have requested federal assistance through discretionary apportionments. A National Priority Ranking System is used to evaluate and rank each airport project. Those projects with the highest priority are given preference in funding.

Under the AIP program, examples of eligible development projects include the airfield, public aprons, and access roads. Additional buildings and structures may be eligible if the function of the structure is to serve airport operations in a non-revenue-generating capacity. For example, the maintenance barn is partially eligible for funding since the barn will house equipment that will be used by the airport in addition to uses off the airport. Under current FAA funding policy, construction of some revenue-generating facilities, such as T-hangars, may be eligible if all airside requirements have been met.

Whereas entitlement monies are guaranteed on an annual basis, discretionary funds are not assured. If the combination of entitlement, discretionary, and airport sponsor match, does not provide enough capital for planned development, projects may be delayed. Other supplemental funding sources are described in the following subsections.

Entitlement Funds

AIP provides funding for eligible projects at airports through an entitlement program. Primary commercial service airports receive a guaranteed minimum of federal assistance each year, based on their enplaned passenger levels and Congressional appropriation levels. A primary airport is defined as any commercial service airport enplaning at least 10,000 passengers annually. *Vision 100* and the previous bill, *AIR-21*, adjusted allocation formulas to increase entitlements over previous levels and to establish special set-asides for noise programs, general aviation and non-primary airports, and other special programs.

Under the entitlement formula, airports enplaning 10,000 or more passengers annually will receive the higher of \$1.0 million or an amount based upon the entitlement formula. The entitlement formula is based upon \$15.60 per enplaned passenger for the first 50,000 enplanements, and \$10.40 per enplanement for the next 50,000 enplanements. The next 400,000 enplanements provide \$5.20 each, and an airport receives \$1.30 for the next 500,000 enplanements. For each annual enplanement above one million, the airport will receive \$1.00. While the entitlement amounts are double the levels authorized previously, they may be reduced proportionally if Congress does not annually appropriate at least \$3.2 billion.

A primary airport will receive the minimum entitlement level until annual enplanements exceed 71,154. The Lincoln Airport would have received approximately \$1.83 million for

FAA Fiscal Year 2006 based on an enplanement level of 202,917. Provided the entitlement formula remains the same throughout the next 20 years, the Lincoln Airport entitlement funding levels will continue to grow as presented in **Table 6B**.

| Period | Passenger Enplanement Forecast | Fiscal Year AIP Entitle- ments |
|-------------------|---|---|
| Short Term | 252,000 | \$2,090,400 |
| Intermediate Term | 281,000 | \$2,241,200 |
| Long Term | 351,000 | \$2,605,200 |

In addition, airports that have over 100 million pounds of landed weight by all-cargo carriers receive a cargo entitlement. The national cargo entitlement fund is established at three percent of the annual AIP appropriation. The airport cargo entitlement is based upon the airport's percentage of total landed weight at all eligible airports. The Lincoln Airport air cargo figures are not anticipated to exceed the federal threshold for entitlement funds through the planning period.

Discretionary Funds

In a number of cases, airports face major projects that will require funds in excess of the airport's annual entitlements. Thus, additional funds from discretionary apportionments under AIP become desirable. The primary feature about discretionary funds is that they are distributed on a priority basis. These priorities are established

by the FAA, utilizing a priority code system. Under this system, projects are ranked by their purpose. Projects ensuring airport safety and security are ranked as the most important priorities, followed by maintaining current infrastructure development, mitigating noise and other environmental impacts, meeting standards, and increasing system capacity.

It is important to note that competition for discretionary funding is not limited to airports in the State of Nebraska or those within the FAA Central Region. The funds are distributed to all airports in the country and, as such, are more difficult to obtain. High priority projects will often fare favorably, while lower priority projects many times will not receive discretionary grants.

PASSENGER FACILITY CHARGES

The *Aviation Safety and Capacity Expansion Act of 1990* contained a provision for airports to levy passenger facility charges (PFCs) for the purposes of enhancing airport safety, capacity, security, or to reduce noise or enhance competition.

14 CFR, Part 158, of May 29, 1991, establishes the regulations that must be followed by airports choosing to levy PFCs. Passenger facility charges may be imposed by public agencies controlling a commercial service airport with at least 2,500 annual passengers with scheduled service. Authorized agencies were allowed to impose a charge of \$1.00, \$2.00, or \$3.00 per enplaned

passenger. Legislation (*AIR-21*) passed in 2000 allowed the cap to increase to \$4.50, which remains the current cap level under *Vision 100*. Prior approval is required from the Department of Transportation (DOT) before an airport is allowed to levy a PFC. The DOT must find that the projected revenues are needed for specific, approved projects. Any AIP-eligible project, whether development or planning related, is eligible for PFC funding. Gates and related areas for the movement of passengers and baggage are eligible, as are on-airport ground access projects. Any project approved must preserve or enhance safety, security, or capacity; reduce/mitigate noise impacts; or enhance competition among carriers.

PFCs may be used only on approved projects. However, PFCs can be utilized to fund 100 percent of a project. They may also be used as matching funds for AIP grants or to augment AIP-funded projects. PFCs can be used for debt service and financing costs of bonds for eligible airport development. These funds may also be commingled with general revenue for bond debt service. Before submitting a PFC application, the airport must give notice and an opportunity for consultation with airlines operating at the airport.

PFCs are to be treated similar to other airport improvement grants, rather than as airport revenues, and are administered by the FAA. Airlines retain up to 11 cents per passenger for collecting PFCs. It should also be noted that only revenue passengers pay PFCs. Non-revenue passengers,

such as those using frequent flier rewards or airline personnel, are counted as enplanements but do not generate PFCs.

The Lincoln Airport does not currently collect a PFC.

STATE FUNDING PROGRAMS

In support of the state aviation system, the Nebraska Department of Aeronautics (NDA) also participates in airport improvement projects. The source for state airport improvement funds is the 1999 *State Aid Program* which was approved in 2003. This program is administered by the Nebraska Department of Aeronautics.

Under the program, all Nebraska public use airports that are included in the Nebraska State Aviation System Plan are eligible. The funding limits are as follows:

- State projects: up to 90 percent state funds.
- State projects acquiring land or terminal buildings: 50 percent state funds.
- Federal projects: 3 percent state funds on federally funded projects with total costs greater than \$500,000.

State funds are limited to \$100,000 per airport per fiscal year, except that runway construction for state-aid only projects is limited to \$200,000. State funds allocated for a federal project are limited to a total of \$100,000. A federal project includes the entire scope of the

federal grant. Multiple grants which are used to finance the same scope of work are considered to be one project.

The NDA offers several other funding programs. The newest program is the *Revolving Hangar Program* of 2006. This program provides no interest loans to public use airports for hangar construction (typically T-hangar construction). The NDA will provide up to 70 percent of the cost of new construction and 50 percent of eligible costs for existing hangar rehabilitation and/or door replacement, up to the amount approved by the Nebraska Aeronautics Commission (NAC). The maximum loan amount is a total of \$300,000, inclusive of all loans made under the program. New construction must be repaid in 10 years and rehabilitation or door replacement must be repaid in five years.

The NDA and the NAC also offer the *Fuel Storage Loan Program* of 2004. This is a no interest loan for the expansion of static fuel storage facilities. Mobile tanks are not eligible for this program. Additional fuel storage capacity must first be justified through fuel sales records. This program will provide up to 70 percent funding with a \$50,000 cap. The balance must be repaid within 10 years.

The NDA and NAC also offer a pavement marking program, a crack and joint sealing program, and a pavement preservation program. These programs generally provide no interest loans covering up to 75 percent of the project cost.

FAA FACILITIES AND EQUIPMENT PROGRAM

The Airway Facilities Division of the FAA administers the national Facilities and Equipment (F&E) Program. This annual program provides funding for the installation and maintenance of various navigational aids and equipment for the national airspace system and airports. Under the F&E program, funding is provided for FAA airport traffic control towers, enroute navigational aids (such as a VOR), and on-airport navigational aids (such as REILs and approach lighting systems). As activity levels rise, the airport may be considered by the FAA Airways Facilities Division for the installation and maintenance of navigational aids through the F&E program.

SUMMARY

The best means to begin implementation of the recommendations in this master plan is to first recognize that planning is a continuous process that does not end with completion and approval of this document. Rather, the ability to continuously monitor the existing and forecast status of airport activity must be provided and maintained. The issues upon which this master plan is based will remain valid for a number of years. The primary goal is for the airport to best serve the air transportation needs of the region, while continuing to be economically self-sufficient.

The actual need for facilities is most appropriately established by airport activity levels rather than a specified date. For example, projections have

been made as to when additional hangars may be needed at the airport. In reality, however, the timeframe in which the development is needed may be substantially different. Actual demand may be slower to develop than expected. On the other hand, high levels of demand may establish the need to accelerate the development. Although every effort has been made in this master planning process to conservatively estimate when facility development may be needed, aviation demand will dictate when facility improvements need to be delayed or accelerated.

The real value of a usable master plan is in keeping the issues and objectives in the minds of the managers and decision-makers so that they are better able to recognize change and its effect. In addition to adjustments in aviation demand, decisions made as to when to undertake the improvements recommended in this master plan will impact the period that the plan remains valid. The format used in this plan is intended to reduce the need for formal and costly updates by simply adjusting the timing. Updating can be done by the manager, thereby improving the plan's effectiveness.

In summary, the planning process requires the airport management consistently monitor the progress of the airport in terms of aircraft operations and based aircraft. Analysis of aircraft demand is critical to the timing and need for new airport facilities. The information obtained from continually monitoring airport activity will provide the data necessary to determine if the development schedule should be accelerated or decelerated.

GLOSSARY OF TERMS

Glossary of Terms

ABOVE GROUND LEVEL: The elevation of a point or surface above the ground.

ACCELERATE-STOP DISTANCE AVAILABLE (ASDA): See declared distances.

ADVISORY CIRCULAR: External publications issued by the FAA consisting of non-regulatory material providing for the recommendations relative to a policy, guidance and information relative to a specific aviation subject.

AIR CARRIER: An operator which: (1) performs at least five round trips per week between two or more points and publishes flight schedules which specify the times, days of the week, and places between which such flights are performed; or (2) transport mail by air pursuant to a current contract with the U.S. Postal Service. Certified in accordance with Federal Aviation Regulation (FAR) Parts 121 and 127.

AIRCRAFT: A transportation vehicle that is used or intended for use for flight.

AIRCRAFT APPROACH CATEGORY: An alphabetic classification of aircraft based upon 1.3 times the stall speed in a landing configuration at their maximum certified landing weight.

AIRCRAFT OPERATION: The landing, takeoff, or touch-and-go procedure by an aircraft on a runway at an airport.

AIRCRAFT OPERATIONS AREA: A restricted and secure area on the airport property designed to protect all aspects related to aircraft operations.

AIRCRAFT OWNERS AND PILOTS ASSOCIATION: A private organization serving the interests and needs of general aviation pilots and aircraft owners.

AIRCRAFT APPROACH CATEGORY: A grouping of aircraft based on 1.3 times the stall speed in their landing configuration at their maximum certificated landing weight. The categories are as follows:

- *Category A:* Speed less than 91 knots.
- *Category B:* Speed 91 knots or more, but less than 121 knots.
- *Category C:* Speed 121 knots or more, but less than 141 knots.
- *Category D:* Speed 141 knots or more, but less than 166 knots.
- *Category E:* Speed greater than 166 knots.

AIRCRAFT RESCUE AND FIRE FIGHTING: A facility located at an airport that provides emergency vehicles, extinguishing agents, and personnel responsible for minimizing the impacts of an aircraft accident or incident.

AIRFIELD: The portion of an airport which contains the facilities necessary for the operation of aircraft.

AIRLINE HUB: An airport at which an airline concentrates a significant portion of its activity and which often has a significant amount of connecting traffic.

AIRPLANE DESIGN GROUP (ADG): A grouping of aircraft based upon wingspan. The groups are as follows:

- *Group I:* Up to but not including 49 feet.
- *Group II:* 49 feet up to but not including 79 feet.
- *Group III:* 79 feet up to but not including 118 feet.
- *Group IV:* 118 feet up to but not including 171 feet.
- *Group V:* 171 feet up to but not including 214 feet.
- *Group VI:* 214 feet or greater.

AIRPORT AUTHORITY: A quasi-governmental public organization responsible for setting the policies governing the management and operation of an airport or system of airports under its jurisdiction.

AIRPORT BEACON: A navigational aid located at an airport which displays a rotating light beam to identify whether an airport is lighted.

AIRPORT CAPITAL IMPROVEMENT PLAN: The planning program used by the Federal Aviation Administration to identify, prioritize, and distribute funds for airport development and the needs of the National Airspace System to meet specified national goals and objectives.

AIRPORT ELEVATION: The highest point on the runway system at an airport expressed in feet above mean sea level (MSL).

AIRPORT LAYOUT DRAWING (ALD): The drawing of the airport showing the layout of existing and proposed airport facilities.

AIRPORT MASTER PLAN: The planner's concept of the long-term development of an airport.

AIRPORT MOVEMENT AREA SAFETY SYSTEM: A system that provides automated alerts and warnings of potential runway incursions or other hazardous aircraft movement events.

AIRPORT OBSTRUCTION CHART: A scaled drawing depicting the Federal Aviation Regulation (FAR) Part 77 surfaces, a representation of objects that penetrate these surfaces, runway, taxiway, and ramp areas, navigational aids, buildings, roads and other detail in the vicinity of an an airport.

AIRPORT REFERENCE CODE (ARC): A coding system used to relate airport design criteria to the operational (Aircraft Approach Category) to the physical characteristics (Airplane Design Group) of the airplanes intended to operate at the airport.

AIRPORT REFERENCE POINT (ARP): The latitude and longitude of the approximate center of the airport.

AIRPORT SPONSOR: The entity that is legally responsible for the management and operation of an airport, including the fulfillment of the requirements of laws and regulations related thereto.

AIRPORT SURFACE DETECTION EQUIPMENT: A radar system that provides air traffic controllers with a visual representation of the movement of aircraft and other vehicles on the ground on the airfield at an airport.

AIRPORT SURVEILLANCE RADAR: The primary radar located at an airport or in an air traffic control terminal area that receives a signal at an antenna and transmits the signal to air traffic control display equipment defining the location of aircraft in the air. The signal provides only the azimuth and range of aircraft from the location of the antenna.

AIRPORT TRAFFIC CONTROL TOWER (ATCT): A central operations facility in the terminal air traffic control system, consisting of a tower, including an associated instrument flight rule (IFR) room if radar equipped, using air/ground communications and/or radar, visual signaling and other devices to provide safe and expeditious movement of terminal air traffic.

AIR ROUTE TRAFFIC CONTROL CENTER: A facility which provides enroute air traffic control service to aircraft operating on an IFR flight plan within controlled airspace over a large, multi-state region.

AIRSIDE: The portion of an airport that contains the facilities necessary for the operation of aircraft.

AIRSPACE: The volume of space above the surface of the ground that is provided for the operation of aircraft.

AIR TAXI: An air carrier certificated in accordance with FAR Part 121 and FAR Part 135 and authorized to provide, on demand, public transportation of persons and property by aircraft. Generally operates small aircraft "for hire" for specific trips.

AIR TRAFFIC CONTROL: A service operated by an appropriate organization for the purpose of providing for the safe, orderly, and expeditious flow of air traffic.

AIR ROUTE TRAFFIC CONTROL CENTER (ARTCC): A facility established to provide air traffic control service to aircraft operating on an IFR flight plan within controlled airspace and principally during the enroute phase of flight.

AIR TRAFFIC HUB: A categorization of commercial service airports or group of commercial service airports in a metropolitan or urban area based upon the proportion of annual national enplanements existing at the airport or airports. The categories are large hub, medium hub, small hub, or non-hub. It forms the basis for the apportionment of entitlement funds.

AIR TRANSPORT ASSOCIATION OF AMERICA: An organization consisting of the principal U.S. airlines that represents the interests of the airline industry on major aviation issues before federal, state, and local government bodies. It promotes air transportation safety by coordinating industry and governmental safety programs and it serves as a focal point for industry efforts to standardize practices and enhance the efficiency of the air transportation system.

ALERT AREA: See special-use airspace.

ALTITUDE: The vertical distance measured in feet above mean sea level.

ANNUAL INSTRUMENT APPROACH (AIA): An approach to an airport with the intent to land by an aircraft in accordance with an IFR

flight plan when visibility is less than three miles and/or when the ceiling is at or below the minimum initial approach altitude.

APPROACH LIGHTING SYSTEM (ALS): An airport lighting facility which provides visual guidance to landing aircraft by radiating light beams by which the pilot aligns the aircraft with the extended centerline of the runway on his final approach and landing.

APPROACH MINIMUMS: The altitude below which an aircraft may not descend while on an IFR approach unless the pilot has the runway in sight.

APPROACH SURFACE: An imaginary obstruction limiting surface defined in FAR Part 77 which is longitudinally centered on an extended runway centerline and extends outward and upward from the primary surface at each end of a runway at a designated slope and distance based upon the type of available or planned approach by aircraft to a runway.

APRON: A specified portion of the airfield used for passenger, cargo or freight loading and unloading, aircraft parking, and the refueling, maintenance and servicing of aircraft.

AREA NAVIGATION: The air navigation procedure that provides the capability to establish and maintain a flight path on an arbitrary course that remains within the coverage area of navigational sources being used.

AUTOMATED TERMINAL INFORMATION SERVICE (ATIS): The continuous broadcast of recorded non-control information at towered airports. Information typically includes wind speed, direction, and runway in use.

AUTOMATED SURFACE OBSERVATION SYSTEM (ASOS): A reporting system that provides frequent airport ground surface weather observation data through digitized voice broadcasts and printed reports.

AUTOMATED WEATHER OBSERVATION STATION (AWOS): Equipment used to automatically record weather conditions (i.e. cloud height, visibility, wind speed and direction, temperature, dewpoint, etc.)

AUTOMATIC DIRECTION FINDER (ADF): An aircraft radio navigation system which senses and indicates the direction to a non-directional radio beacon (NDB) ground transmitter.

AVIGATION EASEMENT: A contractual right or a property interest in land over which a right of unobstructed flight in the airspace is established.

AZIMUTH: Horizontal direction expressed as the angular distance between true north and the direction of a fixed point (as the observer's heading).

BASE LEG: A flight path at right angles to the landing runway off its approach end. The base leg normally extends from the downwind leg to the intersection of the extended runway centerline. See "traffic pattern."

BASED AIRCRAFT: The general aviation aircraft that use a specific airport as a home base.

BEARING: The horizontal direction to or from any point, usually measured clockwise from true north or magnetic north.

BLAST FENCE: A barrier used to divert or dissipate jet blast or propeller wash.

BLAST PAD: A prepared surface adjacent to the end of a runway for the purpose of eliminating the erosion of the ground surface by the wind forces produced by airplanes at the initiation of takeoff operations.

BUILDING RESTRICTION LINE (BRL): A line which identifies suitable building area locations on the airport.

CAPITAL IMPROVEMENT PLAN: The planning program used by the Federal Aviation Administration to identify, prioritize, and distribute Airport Improvement Program funds for airport development and the needs of the National Airspace System to meet specified national goals and objectives.

CARGO SERVICE AIRPORT: An airport served by aircraft providing air transportation of property only, including mail, with an annual aggregate landed weight of at least 100,000,000 pounds.

CATEGORY I: An Instrument Landing System (ILS) that provides acceptable guidance information to an aircraft from the coverage limits of the ILS to the point at which the localizer course line intersects the glide path at a decision height of 100 feet above the horizontal plane containing the runway threshold.

CATEGORY II: An ILS that provides acceptable guidance information to an aircraft from the coverage limits of the ILS to the point at which the localizer course line intersects the glide path at a decision height of 50 feet above the horizontal plane containing the runway threshold.

CATEGORY III: An ILS that provides acceptable guidance information to a pilot from the coverage limits of the ILS with no decision height specified above the horizontal plane containing the runway threshold.

CEILING: The height above the ground surface to the location of the lowest layer of clouds which is reported as either broken or overcast.

CIRCLING APPROACH: A maneuver initiated by the pilot to align the aircraft with the runway for landing when flying a predetermined circling instrument approach under IFR.

CLASS A AIRSPACE: See Controlled Airspace.

CLASS B AIRSPACE: See Controlled Airspace.

CLASS C AIRSPACE: See Controlled Airspace.

CLASS D AIRSPACE: See Controlled Airspace.

CLASS E AIRSPACE: See Controlled Airspace.

CLASS G AIRSPACE: See Controlled Airspace.

CLEAR ZONE: See Runway Protection Zone.

COMMERCIAL SERVICE AIRPORT: A public airport providing scheduled passenger service that enplanes at least 2,500 annual passengers.

COMMON TRAFFIC ADVISORY FREQUENCY: A radio frequency identified in the appropriate aeronautical chart which is designated for the purpose of transmitting airport advisory information and procedures while operating to or from an uncontrolled airport.

COMPASS LOCATOR (LOM): A low power, low/medium frequency radio-beacon installed in conjunction with the instrument landing system at one or two of the marker sites.

CONICAL SURFACE: An imaginary obstruction-limiting surface defined in FAR Part 77 that extends from the edge of the horizontal surface outward and upward at a slope of 20 to 1 for a horizontal distance of 4,000 feet.

CONTROLLED AIRPORT: An airport that has an operating airport traffic control tower.

CONTROLLED AIRSPACE: Airspace of defined dimensions within which air traffic control services are provided to instrument flight rules (IFR) and visual flight rules (VFR) flights in accordance with the airspace classification. Controlled airspace in the United States is designated as follows:

- **CLASS A:** Generally, the airspace from 18,000 feet mean sea level (MSL) up to but

not including flight level FL600. All persons must operate their aircraft under IFR.

- **CLASS B:** Generally, the airspace from the surface to 10,000 feet MSL surrounding the nation's busiest airports. The configuration of Class B airspace is unique to each airport, but typically consists of two or more layers of air space and is designed to contain all published instrument approach procedures to the airport. An air traffic control clearance is required for all aircraft to operate in the area.
- **CLASS C:** Generally, the airspace from the surface to 4,000 feet above the airport elevation (charted as MSL) surrounding those airports that have an operational control tower and radar approach control and are served by a qualifying number of IFR operations or passenger enplanements. Although individually tailored for each airport, Class C airspace typically consists of a surface area with a five nautical mile (nm) radius and an outer area with a 10 nautical mile radius that extends from 1,200 feet to 4,000 feet above the airport elevation. Two-way radio communication is required for all aircraft.
- **CLASS D:** Generally, that airspace from the surface to 2,500 feet above the air port elevation (charted as MSL) surrounding those airport that have an operational control tower. Class D airspace is individually tailored and configured to encompass published instrument approach procedures. Unless otherwise authorized, all persons must establish two-way radio communication.
- **CLASS E:** Generally, controlled airspace that is not classified as Class A, B, C, or D. Class E airspace extends upward from either the surface or a designated altitude to the overlying or adjacent controlled airspace. When designated as a surface area, the airspace will be configured to contain all instrument

procedures. Class E airspace encompasses all Victor Airways. Only aircraft following instrument flight rules are required to establish two-way radio communication with air traffic control.

- **CLASS G:** Generally, that airspace not classified as Class A, B, C, D, or E. Class G airspace is uncontrolled for all aircraft. Class G airspace extends from the surface to the overlying Class E airspace.

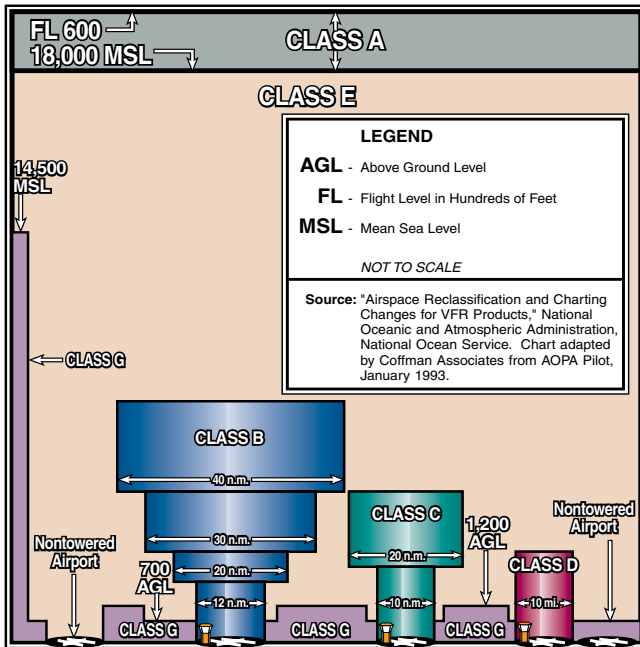

CONTROLLED FIRING AREA: See special-use airspace.

CROSSWIND: A wind that is not parallel to a runway centerline or to the intended flight path of an aircraft.

CROSSWIND COMPONENT: The component of wind that is at a right angle to the runway centerline or the intended flight path of an aircraft.

CROSSWIND LEG: A flight path at right angles to the landing runway off its upwind end. See "traffic pattern."

DECIBEL: A unit of noise representing a level relative to a reference of a sound pressure 20 micro newtons per square meter.

DECISION HEIGHT: The height above the end of the runway surface at which a decision must be made by a pilot during the ILS or Precision Approach Radar approach to either continue the approach or to execute a missed approach.

DECLARED DISTANCES: The distances declared available for the airplane's takeoff runway, takeoff distance, accelerate-stop distance, and landing distance requirements. The distances are:

- **TAKEOFF RUNWAY AVAILABLE (TORA):** The runway length declared available and suitable for the ground run of an airplane taking off;
- **TAKEOFF DISTANCE AVAILABLE (TODA):** The TORA plus the length of any remaining runway and/or clear way beyond the far end of the TORA;
- **ACCELERATE-STOP DISTANCE AVAILABLE (ASDA):** The runway plus stopway length declared available for the acceleration and deceleration of an aircraft aborting a takeoff; and
- **LANDING DISTANCE AVAILABLE (LDA):** The runway length declared available and suitable for landing.

DEPARTMENT OF TRANSPORTATION: The cabinet level federal government organization consisting of modal operating agencies, such as the Federal Aviation Administration, which was established to promote the coordination of federal transportation programs and to act as a focal point for research and development efforts in transportation.

DISCRETIONARY FUNDS: Federal grant funds that may be appropriated to an airport based upon designation by the Secretary of Transportation or Congress to meet a specified national priority such as enhancing capacity, safety, and security, or mitigating noise.

DISPLACED THRESHOLD: A threshold that is located at a point on the runway other than the designated beginning of the runway.

DISTANCE MEASURING EQUIPMENT (DME):

Equipment (airborne and ground) used to measure, in nautical miles, the slant range distance of an aircraft from the DME navigational aid.

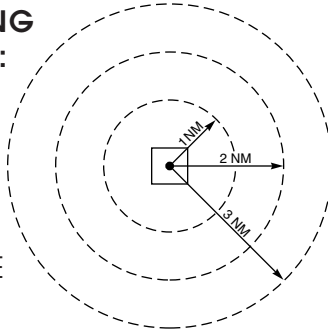

DNL: The 24-hour average sound level, in A-weighted decibels, obtained after the addition of ten decibels to sound levels for the periods between 10 p.m. and 7 a.m. as averaged over a span of one year. It is the FAA standard metric for determining the cumulative exposure of individuals to noise.

DOWNWIND LEG: A flight path parallel to the landing runway in the direction opposite to landing. The downwind leg normally extends between the crosswind leg and the base leg. Also see "traffic pattern."

EASEMENT: The legal right of one party to use a portion of the total rights in real estate owned by another party. This may include the right of passage over, on, or below the property; certain air rights above the property, including view rights; and the rights to any specified form of development or activity, as well as any other legal rights in the property that may be specified in the easement document.

ELEVATION: The vertical distance measured in feet above mean sea level.

ENPLANED PASSENGERS: The total number of revenue passengers boarding aircraft, including originating, stop-over, and transfer passengers, in scheduled and non-scheduled services.

ENPLANEMENT: The boarding of a passenger, cargo, freight, or mail on an aircraft at an airport.

ENTITLEMENT: Federal funds for which a commercial service airport may be eligible based upon its annual passenger enplanements.

ENVIRONMENTAL ASSESSMENT (EA): An environmental analysis performed pursuant to the National Environmental Policy Act to determine whether an action would significantly affect the environment and thus require a more detailed environmental impact statement.

ENVIRONMENTAL AUDIT: An assessment of the current status of a party's compliance with applicable environmental requirements of a party's environmental compliance policies, practices, and controls.

ENVIRONMENTAL IMPACT STATEMENT (EIS): A document required of federal agencies by the National Environmental Policy Act for major projects or legislative proposals affecting the environment. It is a tool for decision-making describing the positive and negative effects of a proposed action and citing alternative actions.

ESSENTIAL AIR SERVICE: A federal program which guarantees air carrier service to selected small cities by providing subsidies as needed to prevent these cities from such service.

FEDERAL AVIATION REGULATIONS: The general and permanent rules established by the executive departments and agencies of the Federal Government for aviation, which are published in the Federal Register. These are the aviation subset of the Code of Federal Regulations.

FINAL APPROACH: A flight path in the direction of landing along the extended runway centerline. The final approach normally extends from the base leg to the runway. See "traffic pattern."

FINDING OF NO SIGNIFICANT IMPACT (FONSI): A public document prepared by a Federal agency that presents the rationale why a proposed action will not have a

significant effect on the environment and for which an environmental impact statement will not be prepared.

FIXED BASE OPERATOR (FBO): A provider of services to users of an airport. Such services include, but are not limited to, hangaring, fueling, flight training, repair, and maintenance.

FLIGHT LEVEL: A designation for altitude within controlled airspace.

FLIGHT SERVICE STATION: An operations facility in the national flight advisory system which utilizes data interchange facilities for the collection and dissemination of Notices to Airmen, weather, and administrative data and which provides pre-flight and in-flight advisory services to pilots through air and ground based communication facilities.

FRANGIBLE NAVAID: A navigational aid which retains its structural integrity and stiffness up to a designated maximum load, but on impact from a greater load, breaks, distorts, or yields in such a manner as to present the minimum hazard to aircraft.

GENERAL AVIATION: That portion of civil aviation which encompasses all facets of aviation except air carriers holding a certificate of convenience and necessity, and large aircraft commercial operators.

GLIDESLOPE (GS): Provides vertical guidance for aircraft during approach and landing. The glideslope consists of the following:

1. Electronic components emitting signals which provide vertical guidance by reference to airborne instruments during instrument approaches such as ILS; or
2. Visual ground aids, such as VASI, which provide vertical guidance for VFR approach or for the visual portion of an instrument approach and landing.

GLOBAL POSITIONING SYSTEM (GPS): A system of 24 satellites used as reference points to enable navigators equipped with GPS receivers to determine their latitude, longitude, and altitude.

GROUND ACCESS: The transportation system on and around the airport that provides access to and from the airport by ground transportation vehicles for passengers, employees, cargo, freight, and airport services.

HELIPAD: A designated area for the takeoff, landing, and parking of helicopters.

HIGH INTENSITY RUNWAY LIGHTS: The highest classification in terms of intensity or brightness for lights designated for use in delineating the sides of a runway.

HIGH-SPEED EXIT TAXIWAY: A long radius taxiway designed to expedite aircraft turning off the runway after landing (at speeds to 60 knots), thus reducing runway occupancy time.

HORIZONTAL SURFACE: An imaginary obstruction-limiting surface defined in FAR Part 77 that is specified as a portion of a horizontal plane surrounding a runway located 150 feet above the established airport elevation. The specific horizontal dimensions of this surface are a function of the types of approaches existing or planned for the runway.

INSTRUMENT APPROACH PROCEDURE: A series of predetermined maneuvers for the orderly transfer of an aircraft under instrument flight conditions from the beginning of the initial approach to a landing, or to a point from which a landing may be made visually.

INSTRUMENT FLIGHT RULES (IFR): Procedures for the conduct of flight in weather conditions below Visual Flight Rules weather minimums. The term IFR is often also used to define weather conditions and the type of flight plan under which an aircraft is operating.

INSTRUMENT LANDING SYSTEM (ILS): A precision instrument approach system which normally consists of the following electronic components and visual aids:

1. Localizer.
2. Glide Slope.
3. Outer Marker.
4. Middle Marker.
5. Approach Lights.

INSTRUMENT METEOROLOGICAL CONDITIONS: Meteorological conditions expressed in terms of specific visibility and ceiling conditions that are less than the minimums specified for visual meteorological conditions.

ITINERANT OPERATIONS: Operations by aircraft that are not based at a specified airport.

KNOTS: A unit of speed length used in navigation that is equivalent to the number of nautical miles traveled in one hour.

LANDSIDE: The portion of an airport that provides the facilities necessary for the processing of passengers, cargo, freight, and ground transportation vehicles.

LANDING DISTANCE AVAILABLE (LDA): See declared distances.

LARGE AIRPLANE: An airplane that has a maximum certified takeoff weight in excess of 12,500 pounds.

LOCAL AREA AUGMENTATION SYSTEM: A differential GPS system that provides localized measurement correction signals to the basic GPS signals to improve navigational accuracy, integrity, continuity, and availability.

LOCAL OPERATIONS: Aircraft operations performed by aircraft that are based at the airport and that operate in the local traffic pattern or within sight of the airport, that are known to be departing for or arriving from flights in local practice areas within a prescribed distance from the airport, or that execute simulated instrument approaches at the airport.

LOCAL TRAFFIC: Aircraft operating in the traffic pattern or within sight of the tower, or aircraft known to be departing or arriving from the local practice areas, or aircraft executing practice instrument approach procedures. Typically, this includes touch-and-go training operations.

LOCALIZER: The component of an ILS which provides course guidance to the runway.

LOCALIZER TYPE DIRECTIONAL AID (LDA): A facility of comparable utility and accuracy to a localizer, but is not part of a complete ILS and is not aligned with the runway.

LONG RANGE NAVIGATION SYSTEM (LORAN): Long range navigation is an electronic navigational aid which determines aircraft position and speed by measuring the difference in the time of reception of synchronized pulse signals from two fixed transmitters. Loran is used for enroute navigation.

LOW INTENSITY RUNWAY LIGHTS: The lowest classification in terms of intensity or brightness for lights designated for use in delineating the sides of a runway.

MEDIUM INTENSITY RUNWAY LIGHTS: The middle classification in terms of intensity or brightness for lights designated for use in delineating the sides of a runway.

MICROWAVE LANDING SYSTEM (MLS): An instrument approach and landing system that provides precision guidance in azimuth, elevation, and distance measurement.

MILITARY OPERATIONS: Aircraft operations that are performed in military aircraft.

MILITARY OPERATIONS AREA (MOA): See special-use airspace.

MILITARY TRAINING ROUTE: An air route depicted on aeronautical charts for the conduct of military flight training at speeds above 250 knots.

MISSED APPROACH COURSE (MAC): The flight route to be followed if, after an instrument approach, a landing is not effected, and occurring normally:

1. When the aircraft has descended to the decision height and has not established visual contact; or
2. When directed by air traffic control to pull up or to go around again.

MOVEMENT AREA: The runways, taxiways, and other areas of an airport which are utilized for taxiing/hover taxiing, air taxiing, takeoff, and landing of aircraft, exclusive of loading ramps and parking areas. At those airports with a tower, air traffic control clearance is required for entry onto the movement area.

NATIONAL AIRSPACE SYSTEM: The network of air traffic control facilities, air traffic control areas, and navigational facilities through the U.S.

NATIONAL PLAN OF INTEGRATED AIRPORT SYSTEMS: The national airport system plan developed by the Secretary of Transportation on a biannual basis for the development of public use airports to meet national air transportation needs.

NATIONAL TRANSPORTATION SAFETY BOARD: A federal government organization established to investigate and determine the probable cause of transportation accidents, to recommend equipment and procedures to enhance transportation safety, and to review on appeal the suspension or revocation of any certificates or licenses issued by the Secretary of Transportation.

NAUTICAL MILE: A unit of length used in navigation which is equivalent to the distance spanned by one minute of arc in latitude, that is, 1,852 meters or 6,076 feet. It is equivalent to approximately 1.15 statute mile.

NAVAID: A term used to describe any electrical or visual air navigational aids, lights, signs, and associated supporting equipment (i.e. PAPI, VASI, ILS, etc.)

NOISE CONTOUR: A continuous line on a map of the airport vicinity connecting all points of the same noise exposure level.

NON-DIRECTIONAL BEACON (NDB): A beacon transmitting nondirectional signals whereby the pilot of an aircraft equipped with direction finding equipment can determine his or her bearing to and from the radio beacon and home on, or track to, the station. When the radio beacon is installed in conjunction with the Instrument Landing System marker, it is normally called a Compass Locator.

NON-PRECISION APPROACH PROCEDURE: A standard instrument approach procedure in which no electronic glide slope is provided, such as VOR, TACAN, NDB, or LOC.

NOTICE TO AIRMEN: A notice containing information concerning the establishment, condition, or change in any component of or hazard in the National Airspace System, the timely knowledge of which is considered essential to personnel concerned with flight operations.

OBJECT FREE AREA (OFA): An area on the ground centered on a runway, taxiway, or taxilane centerline provided to enhance the safety of aircraft operations by having the area free of objects, except for objects that need to be located in the OFA for air navigation or aircraft ground maneuvering purposes.

OBSTACLE FREE ZONE (OFZ): The airspace below 150 feet above the established airport elevation and along the runway and extended runway centerline that is required to be kept clear of all objects, except for frangible visual NAVAIDs that need to be located in the OFZ because of their function, in order to provide clearance for aircraft landing or taking off from the runway, and for missed approaches.

OPERATION: A take-off or a landing.

OUTER MARKER (OM): An ILS navigation facility in the terminal area navigation system located four to seven miles from

the runway edge on the extended centerline, indicating to the pilot that he/she is passing over the facility and can begin final approach.

PILOT CONTROLLED LIGHTING: Runway lighting systems at an airport that are controlled by activating the microphone of a pilot on a specified radio frequency.

PRECISION APPROACH: A standard instrument approach procedure which provides runway alignment and glide slope (descent) information. It is categorized as follows:

- **CATEGORY I (CAT I):** A precision approach which provides for approaches with a decision height of not less than 200 feet and visibility not less than 1/2 mile or Runway Visual Range (RVR) 2400 (RVR 1800) with operative touchdown zone and runway centerline lights.
- **CATEGORY II (CAT II):** A precision approach which provides for approaches with a decision height of not less than 100 feet and visibility not less than 1200 feet RVR.
- **CATEGORY III (CAT III):** A precision approach which provides for approaches with minima less than Category II.

PRECISION APPROACH PATH INDICATOR (PAPI): A lighting system providing visual approach slope guidance to aircraft during a landing approach. It is similar to a VASI but provides a sharper transition between the colored indicator lights.

PRECISION APPROACH RADAR: A radar facility in the terminal air traffic control system used to detect and display with a high degree of accuracy the direction, range, and elevation of an aircraft on the final approach to a runway.

PRECISION OBJECT FREE AREA (POFA): An area centered on the extended runway centerline, beginning at the runway threshold

and extending behind the runway threshold that is 200 feet long by 800 feet wide. The POFA is a clearing standard which requires the POFA to be kept clear of above ground objects protruding above the runway safety area edge elevation (except for frangible NAVAIDS). The POFA applies to all new authorized instrument approach procedures with less than 3/4 mile visibility.

PRIMARY AIRPORT: A commercial service airport that enplanes at least 10,000 annual passengers.

PRIMARY SURFACE: An imaginary obstruction limiting surface defined in FAR Part 77 that is specified as a rectangular surface longitudinally centered about a runway. The specific dimensions of this surface are a function of the types of approaches existing or planned for the runway.

PROHIBITED AREA: See special-use airspace.

RADIAL: A navigational signal generated by a Very High Frequency Omni-directional Range or VORTAC station that is measured as an azimuth from the station.

REGRESSION ANALYSIS: A statistical technique that seeks to identify and quantify the relationships between factors associated with a forecast.

REMOTE COMMUNICATIONS OUTLET (RCO): An unstaffed transmitter receiver/facility remotely controlled by air traffic personnel. RCOs serve flight service stations (FSSs). RCOs were established to provide ground-to-ground communications between air traffic control specialists and pilots at satellite airports for delivering enroute clearances, issuing departure authorizations, and acknowledging instrument flight rules cancellations or departure/landing times.

REMOTE TRANSMITTER/RECEIVER (RTR): See remote communications outlet. RTRs serve ARTCCs.

RELIEVER AIRPORT: An airport to serve general aviation aircraft which might otherwise use a congested air-carrier served airport.

RESTRICTED AREA: See special-use airspace.

RNAV: Area navigation - airborne equipment which permits flights over determined tracks within prescribed accuracy tolerances without the need to overfly ground-based navigation facilities. Used enroute and for approaches to an airport.

RUNWAY: A defined rectangular area on an airport prepared for aircraft landing and takeoff. Runways are normally numbered in relation to their magnetic direction, rounded off to the nearest 10 degrees. For example, a runway with a magnetic heading of 180 would be designated Runway 18. The runway heading on the opposite end of the runway is 180 degrees from that runway end. For example, the opposite runway heading for Runway 18 would be Runway 36 (magnetic heading of 360). Aircraft can takeoff or land from either end of a runway, depending upon wind direction.

RUNWAY ALIGNMENT INDICATOR LIGHT: A series of high intensity sequentially flashing lights installed on the extended centerline of the runway usually in conjunction with an approach lighting system.

RUNWAY END IDENTIFIER LIGHTS (REIL): Two synchronized flashing lights, one on each side of the runway threshold, which provide rapid and positive identification of the approach end of a particular runway.

RUNWAY GRADIENT: The average slope, measured in percent, between the two ends of a runway.

RUNWAY PROTECTION ZONE (RPZ): An area off the runway end to enhance the protection of people and property on the ground. The RPZ is trapezoidal in shape. Its dimensions are determined by the aircraft approach speed and runway approach type and minima.

RUNWAY SAFETY AREA (RSA): A defined surface surrounding the runway prepared or suitable for reducing the risk of damage to airplanes in the event of an undershoot, overshoot, or excursion from the runway.

RUNWAY VISIBILITY ZONE (RVZ): An area on the airport to be kept clear of permanent objects so that there is an unobstructed line-of-sight from any point five feet above the runway centerline to any point five feet above an intersecting runway centerline.

RUNWAY VISUAL RANGE (RVR): An instrumentally derived value, in feet, representing the horizontal distance a pilot can see down the runway from the runway end.

SCOPE: The document that identifies and defines the tasks, emphasis, and level of effort associated with a project or study.

SEGMENTED CIRCLE: A system of visual indicators designed to provide traffic pattern information at airports without operating control towers.

SHOULDER: An area adjacent to the edge of paved runways, taxiways, or aprons providing a transition between the pavement and the adjacent surface; support for aircraft running off the pavement; enhanced drainage; and blast protection. The shoulder does not necessarily need to be paved.

SLANT-RANGE DISTANCE: The straight line distance between an aircraft and a point on the ground.

SMALL AIRPLANE: An airplane that has a maximum certified takeoff weight of up to 12,500 pounds.

SPECIAL-USE AIRSPACE: Airspace of defined dimensions identified by a surface area wherein activities must be confined because of their nature and/or wherein limitations may be imposed upon aircraft operations that are not a part of those activities. Special-use airspace classifications include:

- **ALERT AREA:** Airspace which may contain a high volume of pilot training activities or an unusual type of aerial activity, neither of which is hazardous to aircraft.
- **CONTROLLED FIRING AREA:** Airspace wherein activities are conducted under conditions so controlled as to eliminate hazards to nonparticipating aircraft and to ensure the safety of persons or property on the ground.
- **MILITARY OPERATIONS AREA (MOA):** Designated airspace with defined vertical and lateral dimensions established outside Class A airspace to separate/segregate certain military activities from instrument flight rule (IFR) traffic and to identify for visual flight rule (VFR) traffic where these activities are conducted.
- **PROHIBITED AREA:** Designated airspace within which the flight of aircraft is prohibited.
- **RESTRICTED AREA:** Airspace designated under Federal Aviation Regulation (FAR) 73, within which the flight of aircraft, while not wholly prohibited, is subject to restriction. Most restricted areas are designated joint use. When not in use by the using agency, IFR/VFR operations can be authorized by the controlling air traffic control facility.
- **WARNING AREA:** Airspace which may contain hazards to nonparticipating aircraft.

STANDARD INSTRUMENT DEPARTURE (SID): A preplanned coded air traffic control IFR departure routing, preprinted for pilot use in graphic and textual form only.

STANDARD TERMINAL ARRIVAL (STAR): A preplanned coded air traffic control IFR arrival routing, preprinted for pilot use in graphic and textual or textual form only.

STOP-AND-GO: A procedure wherein an aircraft will land, make a complete stop on the runway, and then commence a takeoff from

that point. A stop-and-go is recorded as two operations: one operation for the landing and one operation for the takeoff.

STOPWAY: An area beyond the end of a takeoff runway that is designed to support an aircraft during an aborted takeoff without causing structural damage to the aircraft. It is not to be used for takeoff, landing, or taxiing by aircraft.

STRAIGHT-IN LANDING/APPROACH: A landing made on a runway aligned within 30 degrees of the final approach course following completion of an instrument approach.

TACTICAL AIR NAVIGATION (TACAN): An ultra-high frequency electronic air navigation system which provides suitably-equipped aircraft a continuous indication of bearing and distance to the TACAN station.

TAKEOFF RUNWAY AVAILABLE (TORA): See declared distances.

TAKEOFF DISTANCE AVAILABLE (TODA): See declared distances.

TAXILANE: The portion of the aircraft parking area used for access between taxiways and aircraft parking positions.

TAXIWAY: A defined path established for the taxiing of aircraft from one part of an airport to another.

TAXIWAY SAFETY AREA (TSA): A defined surface alongside the taxiway prepared or suitable for reducing the risk of damage to an airplane unintentionally departing the taxiway.

TERMINAL INSTRUMENT PROCEDURES: Published flight procedures for conducting instrument approaches to runways under instrument meteorological conditions.

TERMINAL RADAR APPROACH CONTROL: An element of the air traffic control system responsible for monitoring the en-route and

terminal segment of air traffic in the airspace surrounding airports with moderate to high-levels of air traffic.

TETRAHEDRON: A device used as a landing direction indicator. The small end of the tetrahedron points in the direction of landing.

THRESHOLD: The beginning of that portion of the runway available for landing. In some instances the landing threshold may be displaced.

TOUCH-AND-GO: An operation by an aircraft that lands and departs on a runway without stopping or exiting the runway. A touch-and-go is recorded as two operations: one operation for the landing and one operation for the takeoff.

TOUCHDOWN: The point at which a landing aircraft makes contact with the runway surface.

TOUCHDOWN ZONE (TDZ): The first 3,000 feet of the runway beginning at the threshold.

TOUCHDOWN ZONE ELEVATION (TDZE): The highest elevation in the touchdown zone.

TOUCHDOWN ZONE (TDZ) LIGHTING: Two rows of transverse light bars located symmetrically about the runway centerline normally at 100-foot intervals. The basic system extends 3,000 feet along the runway.

TRAFFIC PATTERN: The traffic flow that is prescribed for aircraft landing at or taking off from an airport. The components of a typical traffic pattern are the upwind leg, crosswind leg, downwind leg, base leg, and final approach.

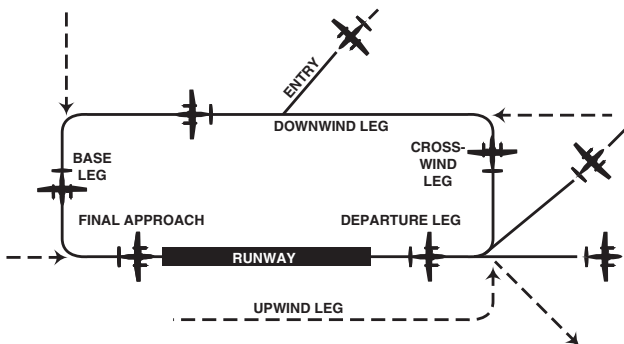

UNCONTROLLED AIRPORT: An airport without an air traffic control tower at which the control of Visual Flight Rules traffic is not exercised.

UNCONTROLLED AIRSPACE: Airspace within which aircraft are not subject to air traffic control.

UNIVERSAL COMMUNICATION (UNICOM): A nongovernment communication facility which may provide airport information at certain airports. Locations and frequencies of UNICOM's are shown on aeronautical charts and publications.

UPWIND LEG: A flight path parallel to the landing runway in the direction of landing. See "traffic pattern."

VECTOR: A heading issued to an aircraft to provide navigational guidance by radar.

VERY HIGH FREQUENCY/ OMNIDIRECTIONAL RANGE STATION (VOR): A ground-based electronic navigation aid transmitting very high frequency navigation signals, 360 degrees in azimuth, oriented from magnetic north. Used as the basis for navigation in the national airspace system. The VOR periodically identifies itself by Morse Code and may have an additional voice identification feature.

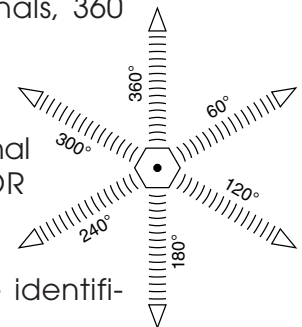

VERY HIGH FREQUENCY OMNI-DIRECTIONAL RANGE STATION/ TACTICAL AIR NAVIGATION (VORTAC): A navigation aid providing VOR azimuth, TACAN azimuth, and TACAN distance-measuring equipment (DME) at one site.

VICTOR AIRWAY: A control area or portion thereof established in the form of a corridor, the centerline of which is defined by radio navigational aids.

VISUAL APPROACH: An approach wherein an aircraft on an IFR flight plan,

operating in VFR conditions under the control of an air traffic control facility and having an air traffic control authorization, may proceed to the airport of destination in VFR conditions.

VISUAL APPROACH SLOPE INDICATOR (VASI):

An airport lighting facility providing vertical visual approach slope guidance to aircraft during approach to landing by radiating a directional pattern of high intensity red and white focused light beams which indicate to the pilot that he is on path if he sees red/white, above path if white/white, and below path if red/red. Some airports serving large aircraft have three-bar VASI's which provide two visual guide paths to the same runway.

VISUAL FLIGHT RULES (VFR): Rules that govern the procedures for conducting flight under visual conditions. The term VFR is also used in the United States to indicate weather conditions that are equal to or greater than minimum VFR requirements. In addition, it is used by pilots and controllers to indicate type of flight plan.

VISUAL METEOROLOGICAL CONDITIONS:

Meteorological conditions expressed in terms of specific visibility and ceiling conditions which are equal to or greater than the threshold values for instrument meteorological conditions.

VOR: See "Very High Frequency Omnidirectional Range Station."

VORTAC: See "Very High Frequency Omnidirectional Range Station/Tactical Air Navigation."

WARNING AREA: See special-use airspace.

WIDE AREA AUGMENTATION SYSTEM: An enhancement of the Global Positioning System that includes integrity broadcasts, differential corrections, and additional ranging signals for the purpose of providing the accuracy, integrity, availability, and continuity required to support all phases of flight.

Abbreviations

| | |
|----------------|--|
| AC: | advisory circular |
| ADF: | automatic direction finder |
| ADG: | airplane design group |
| AFSS: | automated flight service station |
| AGL: | above ground level |
| AIA: | annual instrument approach |
| AIP: | Airport Improvement Program |
| AIR-21: | Wendell H. Ford Aviation Investment and Reform Act for the 21st Century |
| ALS: | approach lighting system |
| ALSF-1: | standard 2,400-foot high intensity approach lighting system with sequenced flashers (CAT I configuration) |
| ALSF-2: | standard 2,400-foot high intensity approach lighting system with sequenced flashers (CAT II configuration) |
| APV: | instrument approach procedure with vertical guidance |
| ARC: | airport reference code |
| ARFF: | aircraft rescue and firefighting |
| ARP: | airport reference point |
| ARTCC: | air route traffic control center |
| ASDA: | accelerate-stop distance available |

| | | | |
|---------------|--|----------------|--|
| ASR: | airport surveillance radar | IM: | inner marker |
| ASOS: | automated surface observation station | LDA: | localizer type directional aid |
| ATCT: | airport traffic control tower | LDA: | landing distance available |
| ATIS: | automated terminal information service | LIRL: | low intensity runway edge lighting |
| AVGAS: | aviation gasoline - typically 100 low lead (100LL) | LMM: | compass locator at middle marker |
| AWOS: | automated weather observation station | LOC: | ILS localizer |
| BRL: | building restriction line | LOM: | compass locator at ILS outer marker |
| CFR: | Code of Federal Regulations | LORAN: | long range navigation |
| CIP: | capital improvement program | MALS: | medium intensity approach lighting system |
| DME: | distance measuring equipment | MALSR: | medium intensity approach lighting system with runway alignment indicator lights |
| DNL: | day-night noise level | MIRL: | medium intensity runway edge lighting |
| DWL: | runway weight bearing capacity for aircraft with dual-wheel type landing gear | MITL: | medium intensity taxiway edge lighting |
| DTWL: | runway weight bearing capacity for aircraft with dual-tandem type landing gear | MLS: | microwave landing system |
| FAA: | Federal Aviation Administration | MM: | middle marker |
| FAR: | Federal Aviation Regulation | MOA: | military operations area |
| FBO: | fixed base operator | MSL: | mean sea level |
| FY: | fiscal year | NAVAID: | navigational aid |
| GPS: | global positioning system | NDB: | nondirectional radio beacon |
| GS: | glide slope | NM: | nautical mile (6,076 .1 feet) |
| HIRL: | high intensity runway edge lighting | NPES: | National Pollutant Discharge Elimination System |
| IFR: | instrument flight rules (FAR Part 91) | NPIAS: | National Plan of Integrated Airport Systems |
| ILS: | instrument landing system | NPRM: | notice of proposed rulemaking |

| | | | |
|---------------|--|----------------|--|
| ODALS: | omnidirectional approach lighting system | SID: | standard instrument departure |
| OFA: | object free area | SM: | statute mile (5,280 feet) |
| OFZ: | obstacle free zone | SRE: | snow removal equipment |
| OM: | outer marker | SSALF: | simplified short approach lighting system with sequenced flashers |
| PAC: | planning advisory committee | SSALR: | simplified short approach lighting system with runway alignment indicator lights |
| PAPI: | precision approach path indicator | STAR: | standard terminal arrival route |
| PFC: | porous friction course | SWL: | runway weight bearing capacity for aircraft with single-wheel type landing gear |
| PFC: | passenger facility charge | STWL: | runway weight bearing capacity for aircraft with single-wheel tandem type landing gear |
| PCL: | pilot-controlled lighting | TACAN: | tactical air navigational aid |
| PIW: | public information workshop | TDZ: | touchdown zone |
| PLASI: | pulsating visual approach slope indicator | TDZE: | touchdown zone elevation |
| POFA: | precision object free area | TAF: | Federal Aviation Administration (FAA) Terminal Area Forecast |
| PVASI: | pulsating/steady visual approach slope indicator | TODA: | takeoff distance available |
| RCO: | remote communications outlet | TORA: | takeoff runway available |
| REIL: | runway end identifier lighting | TRACON: | terminal radar approach control |
| RNAV: | area navigation | VASI: | visual approach slope indicator |
| RPZ: | runway protection zone | VFR: | visual flight rules (FAR Part 91) |
| RSA: | Runway Safety Area | VHF: | very high frequency |
| RTR: | remote transmitter/receiver | VOR: | very high frequency omni-directional range |
| RVR: | runway visibility range | VORTAC: | VOR and TACAN collocated |
| RVZ: | runway visibility zone | | |
| SALS: | short approach lighting system | | |
| SASP: | state aviation system plan | | |
| SEL: | sound exposure level | | |

ENVIRONMENTAL EVALUATION

Appendix B

ENVIRONMENTAL EVALUATION

A review of the potential environmental impacts associated with proposed airport projects is an essential consideration in the airport master plan process. The primary purpose of this evaluation is to review the proposed improvement program for Lincoln Airport to determine whether the proposed actions could, individually or collectively, have the potential to significantly affect the quality of the environment.

Prior to construction of the improvements depicted on the Master Plan Development Concept, compliance with the *National Environmental Policy Act (NEPA) of 1969*, as amended, will be required. For projects not “categorically excluded” under FAA Order 1050.1E, *Environmental Impacts: Policies and Procedures*, compliance with NEPA is generally satisfied through the preparation of an Environmental Assessment (EA). Instances in which significant environmental impacts are expected, an Environmental Impact Statement (EIS) may be required. While this portion of the master plan is not designed to satisfy the NEPA requirements for a categorical exclusion, EA or EIS, it is intended to supply a preliminary review of environmental issues that would need to be analyzed in more detail within the NEPA process.

This evaluation considers all environmental categories required for the NEPA process as outlined in FAA Order 1050.1E, *Environmental Impacts: Policies and Procedures* and FAA Order 5050.4B, *National Environmental Policy Act (NEPA) Implementing Instructions for Airport Actions*. As described within Chapter One, of

the 20 plus environmental categories, the following resources are not found within the airport environs.

- Coastal Resources
- Department of Transportation Act, Section 4(f) Properties
- Wild and Scenic Rivers
- Environmental Justice Areas

The following sections describe potential impacts to the remaining resources (as outlined within Appendix A of FAA Order 1050.1E) as development at the airport is undertaken.

AIR QUALITY

Lincoln Airport is located in Lancaster County which is in attainment for all pollutants regulated through the *Clean Air Act*. It is not anticipated that significant air quality impacts will result from any of the proposed projects.

COMPATIBLE LAND USE

The proposed airport improvements include the acquisition of approximately 256 acres of private property located to the immediate southwest of the airport. This is undeveloped property, much of which is located within the floodplain. In 2003, the airport completed a F.A.R. Part 150 Study which contained a number of recommendations which, if implemented, would result in compatible development within the airport environs in the future.

FARMLAND

As described in Chapter One, much of the undeveloped property surrounding the airport is considered prime farmland by the Natural Resource Conservation Service (NRCS). None of this property is proposed for acquisition or development for aviation purposes. Airport property itself is considered an urban use; therefore, the *Farmland Protection Policy Act* (FPPA) will not apply to the projects proposed within this master plan.

FISH, WILDLIFE, AND PLANTS

It is not anticipated that the projects proposed for acquisition will impact any state or federally listed plant or animal species. As described within Chapter One, saline wetlands provide habitat for the Salt Creek Tiger Beetle, which is a candidate for

federal listing. The saline wetlands located south of the airport facilities, between Oak Creek and Interstate 80, may provide suitable habitat for this species; however, no development is planned in these areas.

FLOODPLAINS

In 2006, the *Oak Creek Levee Study* was undertaken to assess the integrity of the Oak Creek levee system near the airport. The objectives of the study were developed from the design criteria set forth in 44 Code of Federal Regulations (CFR) 65.10 which states, "For levees to be recognized by FEMA (Federal Emergency Management Agency), evidence that adequate design and operation and maintenance systems are in place to provide reasonable assurance that protection from the base flood exists must be provided." The limits of the study extended approximately 1.8 miles from West Mathis Street on the west end of the levee, to near Interstate 80 on the east end of the levee.

The results of the study found that the existing levee elevations do not meet levee freeboard requirements for approximately 74 to 75 percent of the studied levee length. According to 44 CFR 65.10, riverine levees must provide a minimum freeboard of three feet above the water-surface level of the base flood. It was determined that, for the most part, the existing levee system would protect the airport from a 100-year flood event but the three-foot freeboard "buffer" is not provided; therefore, the levee would not be recognized by FEMA as a sufficient levee. In most areas, the levee provides for a freeboard of one foot.

Further analysis determined that the financial impact to the airport during a 100-year flood event, assuming no levee improvements, would be approximately \$3.6 million. This cost includes the replacement of runway and taxiway lights, PAPIs, and the electronic equipment for the MALSR, localizer and glide slope antenna; loss of landing fees during closure; and, runway and taxiway repairs. The Lincoln Airport Authority, in early 2007, requested AIP funds to complete the levee improvement projects. FAA denied this request in a letter dated March 9, 2007 stating that the FAA is of the opinion that bringing the levee up to FEMA standards would not be a reasonable investment of the federal dollar when compared to the risk of the runway pavement being damaged during a flood.

Based on these findings, a Letter of Map Revision was submitted to FEMA in 2007 which reflects the 100-year floodplain without the buffer of the existing levee system. Southern portions of airport property, including the south third of Runway 36, would be in the 100-year floodplain. Due to these revisions, hydrologic studies may be needed prior to additional construction in the 100-year floodplain.

In 2004, the airport undertook a project to improve the levee surrounding that part of Oak Creek traversing through the Lincoln Air Park West industrial park. This

project is intended to contain a 100-year flood event in this area within the Oak Creek channel. A Letter of Map Revision was submitted to FEMA in 2004 to reflect this improvement.

Exhibit B1 reflects the location of the original FEMA 100-year floodplain as well as the areas encompassed by the two Letters of Map Revision submitted to FEMA. Appendix C presents the FAA's position letter on providing grant funding for improvements to the south and east Oak Creek levee.

HAZARDOUS MATERIALS, POLLUTION PREVENTION, AND SOLID WASTE

It is not anticipated that the proposed improvements will result in significant impacts to any of these resources. Areas proposed for significant development between parallel Runways 17-35 and 18-36 were historically used for agricultural purposes and have been regularly mowed and maintained.

HISTORICAL, ARCHITECTURAL, AND CULTURAL RESOURCES

As discussed within Chapter One, the Lincoln Army Air Field Regimental Chapel is located in proximity to the airport along NW 48th Street. Proposed improvements at the airport will not result in direct impacts to this structure as it is not located on airport property. Indirect impacts are not anticipated as the Chapel is not contained within significant noise impact areas.

LIGHT EMISSIONS AND VISUAL IMPACTS

Currently, land immediately surrounding the airport is developed for commercial or industrial uses or is rural in nature. The proposed improvements at the airport will introduce additional landside and airside lighting. Potential impacts will need to be addressed as the areas around the airport continue to develop for residential uses.

WATER QUALITY

The airport is bounded to the west and south by Oak Creek. None of the projects proposed for development at the airport will directly impact this creek. Proposed taxiway development projects will likely not impact the water quality of the creek due to the buffers provided by taxiways and vegetation.

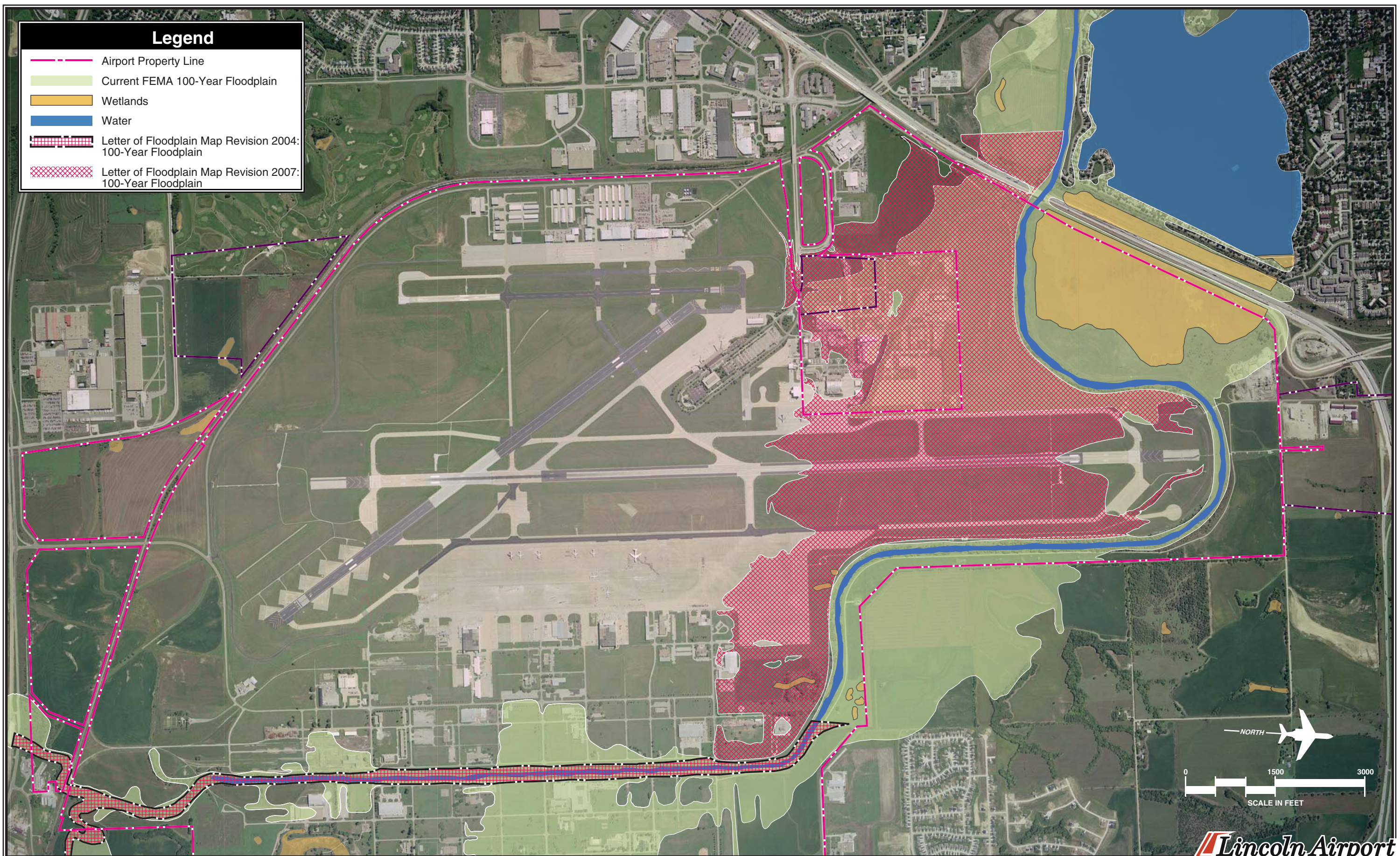

Legend

- Airport Property Line
- Current FEMA 100-Year Floodplain
- Wetlands
- Water
- Letter of Floodplain Map Revision 2004: 100-Year Floodplain
- Letter of Floodplain Map Revision 2007: 100-Year Floodplain

NORTH

0 1500 3000

SCALE IN FEET

WETLANDS

A number of wetland areas were identified within Chapter One and depicted on **Exhibit B1**. All of the wetlands are located well outside project development areas and will not be impacted by the proposed airport improvements.



U.S. Department
Of Transportation

**Federal Aviation
Administration**

Central Region
Iowa, Kansas
Missouri, Nebraska

901 Locust
Kansas City, Missouri 64106-2325

March 9, 2007

Mr. John Wood, Director
Lincoln Airport Authority
P.O. Box 80407
Lincoln, Nebraska 68501

Dear Mr. Wood:

Lincoln Municipal Airport
Lincoln, Nebraska
Oak Creek Levee Improvement

We have reviewed your request for AIP funds to upgrade the Oak Creek Levee near the Lincoln Municipal Airport to the new FEMA standards. After reviewing the cost comparison, completed as part of the Oak Creek Levee Study, it is our opinion that bringing the levee up to FEMA standards would not be a reasonable investment of the Federal dollar compared to the risk of the runway pavement being damaged during a flood.

According to the study, the estimated cost to upgrade the levee is \$1,848,438.00; if no levee exists, the estimated flood damage cost is \$3,591,696.00. \$2,100,00.00 of the estimated total damage is damage to airfield pavement (runway 18/36). Our experience from pervious flood occurrences shows minimal damage to airfield pavements.

In 1993, some of the airports in our region sustained flood damage. The flood was one of the most significant flood occurrences in the Midwest; however, the damage to airfield pavement was minimal. We found that the greatest risk in the flooding of airfield were to the lights.

If you have any questions about our determinations, please call me at (816) 329-2636 or email me at nardos.wills@faa.gov.

Thank you,

Nardos Wills
Nardos Wills
Airport Planning Engineer – Nebraska

RECEIVED

MAR 15 2007

AIRPORT AUTHORITY
CITY OF LINCOLN, NEBR.

Appendix D

AIRPORT PLANS

Airport Master Plan
Lincoln Airport

As part of this master plan, the FAA requires the development of several computer drawings detailing specific parts of the airport and its environs. These drawings were created on a computer-aided drafting system (CAD) and serve as the official depiction of the current and planned condition of the airport. These drawings will be delivered to the FAA for their review and inspection. The FAA will critique the drawings from a technical perspective to be sure all applicable federal regulations are met. The FAA will use the CAD drawings as the basis and justification for funding decisions.

It should be noted that the FAA requires that any changes to the airfield (i.e., runway and taxiway system, etc.) be represented on the drawings. The landside configuration, developed during this master planning process, is also depicted on the drawings but the FAA recognized that landside development is much more fluid and dependent upon developer needs. Thus, an updated drawing set is not necessary for future landside alterations.

The following is a description of the CAD drawings included with this master plan.

AIRPORT LAYOUT PLAN

An official Airport Layout Plan (ALP) drawing has been developed for Lincoln Airport, a draft of which is included in this appendix. The ALP drawing graphically presents the existing and ultimate airport layout plan. The ALP drawing will include such elements as the physical airport features, wind data tabulation,

location of airfield facilities (i.e., runways, taxiways, navigational aids), and existing general aviation development (and commercial development for air carrier airports). Also presented on the ALP are the runway safety areas, airport property boundary, and revenue support areas. The ALP is used by FAA to determine funding eligibility for future capital projects.

The computerized plan provides detailed information on existing and future facility layouts on multiple layers that permit the user to focus on any section of the airport at a desired scale. The plan can be used as base information for design and can be easily updated in the future to reflect new development and more detail concerning existing conditions as made available through design surveys.

AIRSPACE DRAWING

Federal Aviation Regulation (F.A.R.) Part 77, *Objects Affecting Navigable Airspace*, was established for use by local authorities to control the height of objects near airports. The Part 77 Airspace Drawing included in this master plan is a graphic depiction of this regulatory criterion. The Part 77 Airspace Drawing is a tool to aid local authorities in determining if proposed development could present a hazard to aircraft using the airport. The Airspace Drawing can be a critical tool for the airport sponsor's use in planning against future development limitations.

The Lincoln Airport Authority should do all in its power to ensure development stays below the Part 77 surfaces to protect the future role of the airport. The following discussion will describe those approach surfaces that make up the recommended F.A.R. Part 77 operations at Lincoln Airport.

The Part 77 Airspace Drawing assigns three-dimensional imaginary areas to each runway. These imaginary surfaces emanate from the runway centerline and are dimensioned according to the visibility minimums associated with the approach to the runway end and size of aircraft to operate on the runway. The Part 77 imaginary surfaces include the primary surface, approach surface, transitional surface, horizontal surface, and conical surface. Part 77 imaginary surfaces are described as follows.

Primary Surface

The primary surface is an imaginary surface longitudinally centered on the runway. The primary surface extends 200 feet beyond each runway end. The elevation of any point on the primary surface is the same as the elevation along the nearest associated point on the runway centerline. Under Part 77 regulations, the primary surface for all runways is 1,000 feet wide.

Approach Surface

An approach surface is also established for each runway. The approach surface begins at the same width as the primary surface and extends upward and outward from the primary surface end and is centered along an extended runway centerline. The approach surface leading to each runway is based upon the type of approach available (instrument or visual) or planned. The inner edge of the approach surface is the same width as the primary surface and it expands uniformly.

The approach surface for existing Runways 17 and 14 extends 10,000 feet in length to a width of 3,500 feet. The approach surface for Runway 18-36 is 10,000 feet long rising at a 50:1 slope with an additional 40,000 feet at a 40:1 slope. The width of this approach surface is 16,000 feet.

The approach surface to all remaining runways is 10,000 feet long rising at a 34:1 slope to an ultimate width of 3,500 feet.

The approach surface for Runway 18-36 and Runway 17-35 will remain the same through the planning period. The approach slope to Runway 14-32 will change to the same dimensions as Runway 18-36 once a precision GPS approach is approved for the Runway 14 end.

Transitional Surface

Each runway has a transitional surface that begins at the outside edge of the primary surface at the same elevation as the runway. The transitional surface also connects with the approach surfaces of each runway. The surface rises at a slope of 7 to 1, up to a height 150 feet above the highest runway elevation. At that point, the transitional surface is replaced by the horizontal surface.

Horizontal Surface

The horizontal surface is established at 150 feet above the highest elevation of the runway surface. Having no slope, the horizontal surface connects the transitional and approach surfaces to the conical surface at a distance of 10,000 feet from the end of the primary surfaces of each runway.

Conical Surface

The conical surface begins at the outer edge of the horizontal surface. The conical surface then continues for an additional 4,000 feet horizontally at a slope of 20 to 1.

Therefore, at 4,000 feet from the horizontal surface, the elevation of the conical surface is 350 feet above the highest airport elevation.

RUNWAY PROFILE DRAWING

The runway profile drawing presents the entirety of the F.A.R. Part 77 approach surface to each runway end. It also depicts the runway centerline profile with elevations. This drawing provides profile detail that the Airspace Drawing does not. There is a separate drawing for each runway.

INNER APPROACH SURFACE DRAWINGS

The Inner Portion of the Approach Surface Plan is a scaled drawing of the runway protection zone (RPZ), the runway safety area (RSA), the obstacle free zone (OFZ), and the object free area (OFA) for each runway end. A plan and profile view of each RPZ is provided to facilitate identification of obstructions that lie within these safety areas. Detailed obstruction and facility data is provided to identify planned improvements and the disposition of obstructions. A drawing of each runway end is provided.

TERMINAL AREA DRAWING

The terminal area drawing is a larger scale plan view drawing of existing and planned aprons, buildings, hangars, parking lots, and other landside facilities. It is prepared in accordance with FAA AC 150/5300-13, *Airport Design*.

AIRPORT LAND USE DRAWING

The objective of the Airport Land Use Drawing is to coordinate uses of the airport property in a manner compatible with the functional design of the airport facility. Airport land use planning is important for orderly development and efficient use of available space. There are two primary considerations for airport land use planning. These are, first, to secure those areas essential to the safe and efficient operation of the airport; and, second, to determine compatible land uses for the balance of the property which would be most advantageous to the airport and community.

In the development of an airport land use plan for LNK, the airport property was broken into several large general tracts. Each tract was analyzed for specific site characteristics such as: tract size and shape, land characteristics, and existing land uses. The availability of utilities and the accessibility to various transportation

modes were also considered. Limitations and constraints to development such as height and noise restrictions, runway visibility zones, and contiguous land uses were analyzed next. Finally, the compatibility of various land uses in each tract was analyzed.

AIRPORT PROPERTY MAP

The Property Map provides information on the acquisition and identification of all land tracts under control of the airport. Easement interests in areas outside the fee property line are also included. The primary purpose of the drawing is to provide information for analyzing the current and future aeronautical use of land acquired with federal funds.

AIRPORT LAYOUT PLAN FOR LINCOLN AIRPORT LINCOLN, NEBRASKA

INDEX OF DRAWINGS

- | | | |
|---|---|---|
| <p>1. COVER SHEET - SHEET INDEX</p> <p>2. AIRPORT LAYOUT PLAN</p> <p>3. AIRPORT DATA</p> <p>4. AIRPORT AIRSPACE PLAN</p> <p>5. OUTER PORTION OF RUNWAYS 18/36 APPROACH</p> <p>6. OUTER PORTION OF RUNWAYS 14/32 APPROACH</p> <p>7. OUTER PORTION OF RUNWAYS 17/35 APPROACH</p> <p>8. RUNWAY 17/35 LINE OF SIGHT PROFILE - RUNWAY 14/32 LINE OF SIGHT PROFILE - RUNWAY 18/36 LINE OF SIGHT PROFILE</p> <p>9. INNER PORTION OF EXIST/ULT RUNWAY 18 APPROACH SURFACE DRAWING</p> <p>10. INNER PORTION OF EXIST/ULT RUNWAY 36 APPROACH SURFACE DRAWING</p> <p>11. INNER PORTION OF EXIST/ULT RUNWAY 14 APPROACH SURFACE DRAWING</p> | <p>12. RUNWAY 14 OBSTRUCTION TABLES</p> <p>13. INNER PORTION OF EXIST/ULT RUNWAY 32 APPROACH SURFACE DRAWING</p> <p>14. INNER PORTION OF EXIST/ULT RUNWAY 17 APPROACH SURFACE DRAWING</p> <p>15. INNER PORTION OF EXIST/ULT RUNWAY 35 APPROACH SURFACE DRAWING</p> <p>16. TERMINAL AREA DRAWING</p> <p>17. GENERAL AVIATION DRAWING</p> <p>18. LAND USE DRAWING</p> <p>19. AIRPORT PROPERTY MAP</p> <p>20. RUNWAY 18 TERPS 40:1 DEPARTURE SURFACE</p> <p>21. RUNWAY 18 OEI 62.5:1 DEPARTURE SURFACE</p> <p>22. RUNWAY 36 TERPS 40:1 DEPARTURE SURFACE</p> | <p>22. RUNWAY 36 TERPS 40:1 DEPARTURE SURFACE</p> <p>23. RUNWAY 36 OEI 62.5:1 DEPARTURE SURFACE</p> <p>24. RUNWAY 14 TERPS 40:1 DEPARTURE SURFACE</p> <p>25. RUNWAY 14 OEI 62.5:1 DEPARTURE SURFACE</p> <p>26. RUNWAY 32 TERPS 40:1 DEPARTURE SURFACE</p> <p>27. RUNWAY 32 OEI 62.5:1 DEPARTURE SURFACE</p> <p>28. RUNWAY 17 TERPS 40:1 DEPARTURE SURFACE</p> <p>29. RUNWAY 35 TERPS 40:1 DEPARTURE SURFACE</p> |
|---|---|---|

| NO. | REVISIONS | DATE |
|-----|-----------|------|
| - | - | - |
| - | - | - |

COVER SHEET - SHEET INDEX

LINCOLN AIRPORT
LINCOLN, NEBRASKA

LINCOLN OFFICE
625 J St., Box 80388
Lincoln, NE 68501
(402) 479-2200
www.hms.com



PROJECT: ALP
DATE: August 2007
JOB NO.: 36-7049
SHEET NO.:

F:\Transportation\367049\Sheet1.dwg

Mag. Declination 4°17'E (2007)
Changes 07" W Per Year

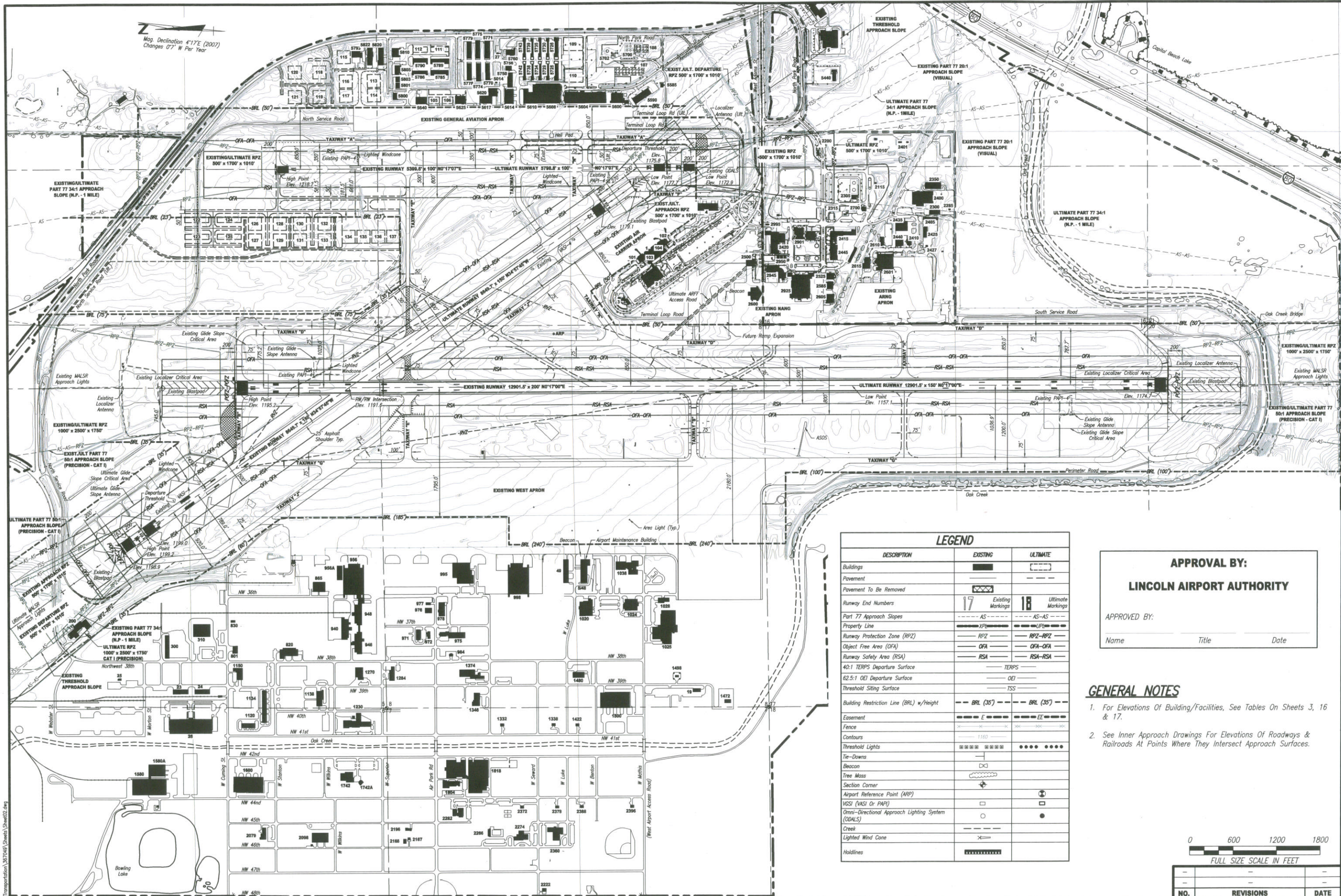

| LEGEND | | |
|---|----------------------|----------------------|
| DESCRIPTION | EXISTING | ULTIMATE |
| Buildings | | |
| Pavement | | |
| Pavement To Be Removed | | |
| Runway End Numbers | 17 Existing Markings | 18 Ultimate Markings |
| Part 77 Approach Slopes | AS-AS | AS-AS |
| Property Line | XP | UP |
| Runway Protection Zone (RPZ) | RPZ | RPZ-RPZ |
| Object Free Area (OFA) | OFA | OFA-OFA |
| Runway Safety Area (RSA) | RSA | RSA-RSA |
| 40:1 TERPS Departure Surface | TERPS | TERPS |
| 62.5:1 OEI Departure Surface | OEI | OEI |
| Threshold Siting Surface | TSS | TSS |
| Building Restriction Line (BRL) w/Height | BRL (35') | BRL (35') |
| Easement | E | EE |
| Fence | | |
| Contours | 1160 | 1160 |
| Threshold Lights | | |
| Tie-Downs | | |
| Beacon | | |
| Tree Mass | | |
| Section Corner | | |
| Airport Reference Point (ARP) | | |
| VGSI (VASI Or PAPI) | | |
| Omni-Directional Approach Lighting System (ODALS) | | |
| Creek | | |
| Lighted Wind Cone | | |
| Holdlines | | |

APPROVAL BY:
LINCOLN AIRPORT AUTHORITY

APPROVED BY: _____
Name Title Date

GENERAL NOTES

- For Elevations Of Building/Facilities, See Tables On Sheets 3, 16 & 17.
- See Inner Approach Drawings For Elevations Of Roadways & Railroads At Points Where They Intersect Approach Surfaces.

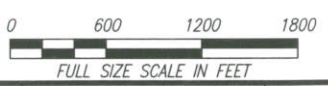

| NO. | REVISIONS | DATE |
|-----|-----------|------|
| | | |
| | | |

AIRPORT LAYOUT PLAN

LINCOLN AIRPORT
LINCOLN, NEBRASKA

LINCOLN OFFICE
625 J. St., Box 80358
Lincoln, NE 68501
(402) 479-2200
www.las.com



PROJECT: ALP
DATE: August 2007
JOB NO.: 36-7049
SHEET NO.: 2/29

F:\Transportation\367049\Sheets\Sheet02.dwg

| RUNWAY DATA | RUNWAY 18/36 | | RUNWAY 14/32 | | RUNWAY 17/35 | |
|--|--|---|--------------------------------------|--|--|-------------------------------------|
| | Existing D-IV 1/2 Mile (CAT I) / 1/2 Mile (CAT I) | Ultimate D-IV 1/2 Mile (CAT I) / 1/2 Mile (CAT I) | Existing C-III 1 Mile / Visual | Ultimate C-III 1/2 Mile (CAT I) / 1 Mile | Existing D-II 1 Mile / Visual | Ultimate D-II 1 Mile / 1 Mile |
| AIRCRAFT APPROACH CATEGORY-DESIGN GROUP | Precision / Precision | | Non-Precision / Visual | | Non-Precision / Non-Precision | |
| APPROACH VISIBILITY MINIMUMS (Lowest) | 50:1 / 50:1 | | 34:1 / 20:1 | | 34:1 / 20:1 | |
| F.A.R. PART 77 CATEGORY | Precision / Precision | | Non-Precision / Visual | | Non-Precision / Non-Precision | |
| PART 77 APPROACH SLOPES | 62.5:1 / 62.5:1 | | NA / NA | | NA / NA | |
| ONE-ENGINE INOPERABLE (OEI) DEPARTURE SURFACE SLOPE | 40:1 / 40:1 | | 40:1 / 40:1 | | 40:1 / 40:1 | |
| TERMINAL INSTRUMENT PROCEDURES (TERPS) DEPARTURE SURFACE SLOPE | 34:1 (Line 9) / 34:1 (Line 9) | | 20:1 (Line 3) / 20:1 (Line 3) | | 20:1 (Line 3) / 20:1 (Line 3) | |
| *THRESHOLD SITING SURFACE (TSS) APPROACH SLOPE | 1195.2 | | 1199.2 | | 1218.6 | |
| RUNWAY PROTECTION ZONE (W1xLxW2) | 1000'x2500'x1750' / 1000'x2500'x1750' | | 500'x1700'x1010' / 500'x1700'x1010' | | 500'x1700'x1010' / 500'x1700'x1010' | |
| MAXIMUM ELEVATION (Above MSL) | 12901.5' x 200' | | 8,649.7' x 150' | | 5,399.6' x 100' | |
| RUNWAY DIMENSIONS | 12901.5' x 150' | | 8,649.7' x 150' | | 5,399.6' x 100' | |
| RUNWAY BEARING | N 0° 17' 00" E | | N 34° 57' 48" W | | N 0° 17' 07" E | |
| RUNWAY THRESHOLD DISPLACEMENT | 0' / 0' | | 363' / 470' | | 0' / 0' (Relocated Threshold) | |
| RUNWAY BLASTPAD LENGTH ALONG CL | 1,000' / 1,000' | | 211' / 198' | | 0' / 0' | |
| RUNWAY SAFETY AREA (RSA) WIDTH | 500' | | 500' | | 500' | |
| RUNWAY SAFETY AREA (RSA) BEYOND RWY END | 1000' | | 1000' | | 1000' | |
| RUNWAY SAFETY AREA (RSA) PRIOR TO LANDING | 600' | | 600' | | 600' | |
| RUNWAY OBSTACLE FREE ZONE (OFZ) WIDTH | 400' | | 400' | | 400' | |
| RUNWAY OBSTACLE FREE ZONE (OFZ) BEYOND RWY END | 200' | | 200' | | 200' | |
| RUNWAY OBJECT FREE AREA (OFA) WIDTH | 800' | | 800' | | 800' | |
| RUNWAY OBJECT FREE AREA (OFA) BEYOND RWY END | 1000' | | 1000' | | 1000' | |
| PAVEMENT SURFACE MATERIAL | Asphalt & Concrete | | Asphalt | | Asphalt & Concrete | |
| PAVEMENT STRENGTH (in thousand lbs.) | 100S : 200D : 400DT | | 80S : 170D : 280DT | | 49S : 60D | |
| RUNWAY EFFECTIVE GRADIENT | 0.30% | | 0.25% | | 0.79% | |
| RUNWAY TOUCHDOWN ZONE ELEVATION (TDZE) | 1195.2 / 1174.7 | | 1199.0 / 1192.1 | | 1218.6 / 1196.9 | |
| RUNWAY MARKING | Precision / Precision | | Non-Precision / Non-Precision | | Non-Precision / Non-Precision | |
| RUNWAY LIGHTING | HIRL | | MIRL | | HIRL | |
| RUNWAY APPROACH LIGHTING | MALSR / MALSR | | None / None | | None / None | |
| TAXIWAY LIGHTING | HITL | | MITL | | HITL | |
| TAXIWAY SURFACE MATERIAL | Asphalt & Concrete | | Asphalt & Concrete | | Asphalt & Concrete | |
| TAXIWAY WIDTH STANDARD | 75' | | 50' | | 35' | |
| TAXIWAY SAFETY AREA WIDTH STANDARD | 171' | | 118' | | 79' | |
| TAXIWAY OBJECT FREE AREA WIDTH STANDARD | 259' | | 186' | | 131' | |
| RUNWAY ELECTRONIC NAVIGATIONAL AIDS | ILS/LOC (18), HI-ILS (18,36), HI-VOR/DME or TACAN (18,36), ILS (36), RNAV/GPS (18) | | RNAV/GPS (14) | | VOR/GPS (17) | |
| RUNWAY VISUAL NAVIGATIONAL AIDS | MALSR (18,36), PAPI-4L (18,36) | | VASI-4L (14,32), REIL (14) | | REIL (17), PAPI-4L (17,35), ODALS (35) | |

*Note: Line Refers To Table A2-1 "Approach/Departure Requirements Table", AC 150/5300-13 CHG 10

| AIRPARK WEST BUILDINGS/FACILITIES | | | AIRPARK WEST BUILDINGS/FACILITIES | | |
|-----------------------------------|--|--------------------|-----------------------------------|---|--------------------|
| Number | Description | Facility Top Elev. | Number | Description | Facility Top Elev. |
| 4 | Range/Training | 1183.0 | 1136 | Storage | 1181.0 |
| 5 | Large Equipment Storage/Shop | 1193.0 | 1138 | Light Industrial/Vehicle Maintenance | 1196.0 |
| 19 | Light Industrial/Warehouse | 1187.0 | 1150 | Light Industrial/Commercial/Warehousing | 1193.0 |
| 23 | Light Industrial/Warehouse | 1191.0 | 1152 | Commercial | 1182.0 |
| 24 | Light Industrial/Warehouse | 1191.0 | 1230 | Commercial | 1185.0 |
| 25 | Storage | 1180.0 | 1270 | Light Industrial/Commercial/Warehousing | 1192.0 |
| 26 | Rail Center Building 1 | 1221.0 | 1284 | Light Industrial/Commercial/Warehousing | 1194.0 |
| 48 | Large Equipment Storage/Shop | 1193.0 | 1332 | Storage | 1181.0 |
| 49 | Large Equipment Storage | 1193.0 | 1338 | Storage | 1181.0 |
| 200 | Light Industrial/Manufacturing | 1206.0 | 1346 | Light Industrial/Commercial | 1189.0 |
| 300 | Light Industrial/Warehouse/Vehicle Maint. | 1197.0 | 1374 | Light Industrial/Commercial | 1190.0 |
| 310 | Industrial/Commercial | 1204.0 | 1380 | Commercial/Laboratory | 1181.0 |
| 801 | Light Industrial/Commercial/Warehouse | 1190.0 | 1422 | Storage | 1181.0 |
| 820 | Industrial/Commercial | 1197.0 | 1472 | Vehicle Maintenance | 1183.0 |
| 830 | Storage | - | 1480 | Storage | 1185.0 |
| 865 | Storage | 1208.0 | 1498 | FAA Remote Transmitter Building | 1173.0 |
| 940 | Industrial/Commercial/Aircraft Maintenance | 1222.0 | 1500 | Light Industrial/Warehousing | 1194.0 |
| 946 | Industrial/Commercial/Aircraft Maintenance | 1221.0 | 1580 | Industrial/Com./Manufacturing/Warehousing | 1205.0 |
| 948 | Industrial/Commercial/Aircraft Maintenance | 1222.0 | 1580A | Warehousing | 1205.0 |
| 956 | Industrial/Commercial/Aircraft Maintenance | 1245.0 | 1600 | Light Industrial/Warehousing | 1196.0 |
| 956A | Office | 1195.0 | 1742 | Light Industrial/Commercial | 1191.0 |
| 971 | Light Industrial/Commercial | 1235.0 | 1742A | Storage | 1187.0 |
| 972 | Commercial Storage | 1183.0 | 1804 | Industrial/Commercial/Warehousing | 1186.0 |
| 975 | Light Industrial/Commercial/Warehouse | 1194.0 | 1818 | Light Industrial/Warehousing | 1198.0 |
| 976 | Storage | 1192.0 | 2079 | Light Industrial/Commercial | 1193.0 |
| 977 | Storage | 1185.0 | 2098 | Laboratory/Training | 1188.0 |
| 978 | Light Industrial/Commercial | 1190.0 | 2167 | Storage | 1181.0 |
| 984 | Storage | 1179.0 | 2168 | Single Family Dwelling | 1186.0 |
| 995 | Industrial/Warehousing | 1203.0 | 2196 | Single Family Dwelling | 1183.0 |
| 998 | Industrial/Warehousing/Aircraft Maint. | 1245.0 | 2222 | Telephone Facility | 1185.0 |
| 1020 | Light Industrial/Commercial | 1191.0 | 2266 | Swimming Pool/Bath House | 1178.0 |
| 1024 | Light Industrial/Commercial | 1192.0 | 2274 | Light Industrial/Commercial | 1187.0 |
| 1025 | Light Industrial/Commercial/Warehousing | 1192.0 | 2282 | Church | 1228.0 |
| 1028 | Light Industrial/Commercial | 1178.0 | 2360 | Sports And Recreation Center | 1199.0 |
| 1033 | Light Industrial/Commercial | 1181.0 | 2372 | Storage | 1179.0 |
| 1034 | Light Industrial/Commercial | 1181.0 | 2378 | Storage | 1179.0 |
| 1038 | Commercial/Warehousing | 1193.0 | 2388 | Storage | 1179.0 |
| 1120 | Warehousing | 1188.0 | 2396 | Storage | 1179.0 |
| 1134 | Light Industrial/Commercial | 1134.0 | | | |

| | RW 18/36 | | RW 14/32 | | RW 17/35 | |
|---|-------------------|-------------------|-----------------|-----------------|-----------------|-----------------|
| | EXISTING | ULTIMATE | EXISTING | ULTIMATE | EXISTING | ULTIMATE |
| TAKEOFF RUN AVAILABLE (TORA) | 12,901.5/12,901.5 | 12,901.5/12,901.5 | 8,649.7/8,649.7 | 8,649.7/8,649.7 | 5,399.6/5,399.6 | 5,798.8/5,798.8 |
| TAKEOFF DISTANCE AVAILABLE (TODA) | 12,901.5/12,901.5 | 12,901.5/12,901.5 | 8,649.7/8,649.7 | 8,649.7/8,649.7 | 5,399.6/5,399.6 | 5,798.8/5,798.8 |
| ACCELERATE-STOP DISTANCE AVAILABLE (ASDA) | 12,901.5/12,901.5 | 12,901.5/12,901.5 | 8,649.7/8,286.7 | 8,649.7/8,286.7 | 5,399.6/5,399.6 | 5,798.8/5,798.8 |
| LANDING DISTANCE AVAILABLE (LDA) | 12,901.5/12,901.5 | 12,901.5/12,901.5 | 8,286.7/7,816.7 | 8,649.7/7,816.7 | 5,399.6/5,399.6 | 5,798.8/5,798.8 |

| AIRPORT DATA | | |
|---|--|--|
| TRANSPORT AIRPORT | EXISTING | FUTURE |
| AIRPORT SERVICE LEVEL | Commercial Service | Commercial Service |
| AIRPORT ELEVATION | 1218.6 | 1218.6 |
| AIRPORT REFERENCE POINT, A.R.P., COORDINATES (Lat. & Long.) | --- | 40°51'03" Lat. 96°45'33" Long. |
| AIRPORT ELECTRONIC AIDS | Rotating Beacon ASR ILS VOR NDB RNAV | Rotating Beacon ASR VOR NDB RNAV |
| DESIGN AIRCRAFT | MD-80 (ARC C-III) | |
| MEAN MAX TEMP. (Hottest Month) | 89.6° F | |
| AIRPORT REFERENCE CODE (ARC) | C-III | D-IV |
| NOTES: | Vertical Datum - NAVD 88 (MSL Elevations) Horizontal Datum - NAD 83 | |

GENERAL NOTES

1) See Sheets 16 & 17 For Terminal And G.A. Apron Building Description & Building Elevation Tables.

| THRESHOLD SITING SURFACE OBJECT PENETRATIONS | | | | |
|---|--------------|----------------------------|-------------|-------------|
| OBJECT/RW END | OBJECT ELEV. | *RW TYPE/SURFACE ELEVATION | PENETRATION | DISPOSITION |
| SEE INNER APPROACH DRAWINGS FOR TSS OBJECT PENETRATION TABLES | | | | |

AC 150/5300-13, CHG 10 (Table A2-1 "Approach/Departure Requirements Table") Was Used To Check Threshold Siting Surfaces

| OBSTACLE FREE ZONE (OFZ) OBJECT PENETRATIONS | | |
|--|-------------|-------------|
| OBJECT | PENETRATION | DISPOSITION |
| None | | |

| RUNWAY END COORDINATES (NAD 83) | | |
|------------------------------------|-----------|--------------|
| Runway 17 | Latitude | 40°51'40.83" |
| | Longitude | 96°45'02.71" |
| Runway 35 Exist./Ult. Departure | Latitude | 40°50'47.48" |
| | Longitude | 96°45'03.06" |
| Runway 35 Ultimate | Latitude | 40°50'43.54" |
| | Longitude | 96°45'03.08" |
| Runway 18 | Latitude | 40°51'46.77" |
| | Longitude | 96°45'42.03" |
| Runway 36 | Latitude | 40°49'39.29" |
| | Longitude | 96°45'42.85" |
| Runway 14 Displaced/Ult. Departure | Latitude | 40°51'59.36" |
| | Longitude | 96°46'08.13" |
| Runway 14 | Latitude | 40°52'02.29" |
| | Longitude | 96°46'10.83" |
| Runway 32 Displaced | Latitude | 40°50'56.07" |
| | Longitude | 96°45'09.83" |
| Runway 32 | Latitude | 40°50'52.26" |
| | Longitude | 96°45'06.32" |

| MODIFICATION | APPROVAL DATE | AIRSPACE CASE NUMBER | DESCRIPTION |
|--|--------------------|----------------------|---|
| Length Of & Distance Between Vertical Curves 1000' Per 1% Grade Change/1000' Times Sum Of Grade Change | February 28, 2001 | 01-ACE-008-NRA | Existing Profile Does Not Exceed 0.8% In First Quarter Of Runway 14 And Sight Deficiency Corrective Action |
| 1000' Object Free Area (OFA) Length Beyond Runway End | February 28, 2001 | 01-ACE-008-NRA | Perimeter Service Road Crosses The Southwestern Corner Of Runway 14 OFA |
| 800' Wide Object Free Area (OFA) 1000' Beyond Runway End | March 13, 2000 | 00-ACE-0050-NRA | Service Road Runs Parallel To And 320' West Of Extended RW Centerline. To Be Relocated To 380' From Runway Centerline |
| 1000' Object Free Area (OFA) Length Beyond Runway End | September 30, 1999 | 99-ACE-0249-NRA | North Service Road Crosses Northeast Corner Of OFA At 930' Beyond Runway 17 End |
| ± 0.8% Runway Gradient | December 6, 1994 | N/A | + 1.6% Runway 17 Gradient |
| ± 0.8% Runway Gradient | January 11, 1990 | N/A | + 1.0% Runway 36 Gradient |

| ALL WEATHER WIND COVERAGE | | | | |
|---------------------------|------------|----------|----------|----------|
| Runway | 10.5 Knots | 13 Knots | 16 Knots | 20 Knots |
| Runway 14-32 | 89.75% | 94.87% | 98.96% | 99.60% |
| Runway 17-36 | 92.70% | 96.32% | 98.86% | 99.69% |
| Runway 18-36 | 92.70% | 96.32% | 98.86% | 99.69% |
| Combind | 97.31% | 98.91% | 99.73% | 99.93% |

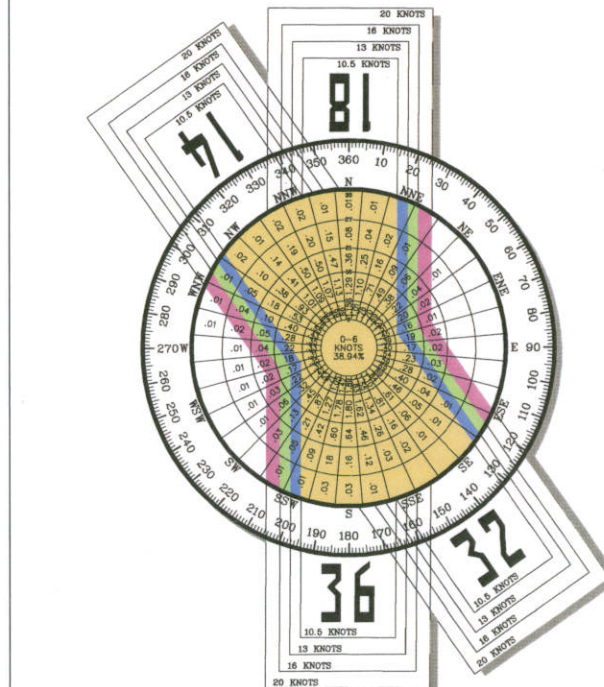

Magnetic Variance
04° 21' East (November 2006)
Annual Rate of Change
00° 07' West (November 2006)

SOURCE:
NOAA National Climatic Center
Asheville, North Carolina
Lincoln Airport (LNK)
Lincoln, Nebraska

OBSERVATIONS:
76,059 All Weather Observations
64,945 IFR CAT-I Observations
1996-2005

| IFR CAT-I WIND COVERAGE | | | | |
|-------------------------|------------|----------|----------|----------|
| Runway | 10.5 Knots | 13 Knots | 16 Knots | 20 Knots |
| Runway 14-32 | 89.55% | 94.75% | 98.94% | 99.60% |
| Runway 17-36 | 92.61% | 96.26% | 98.85% | 99.68% |
| Runway 18-36 | 92.61% | 96.26% | 98.85% | 99.68% |
| Combind | 97.25% | 98.89% | 99.72% | 99.90% |

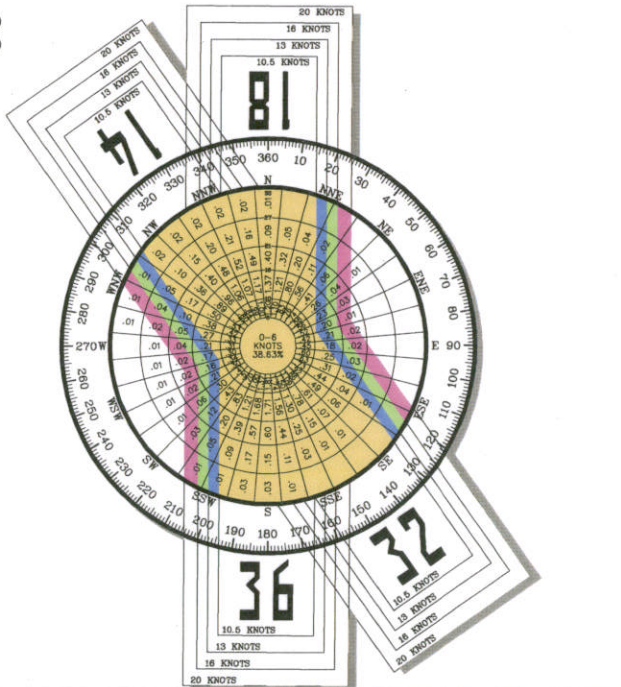



RUNWAY 18 END

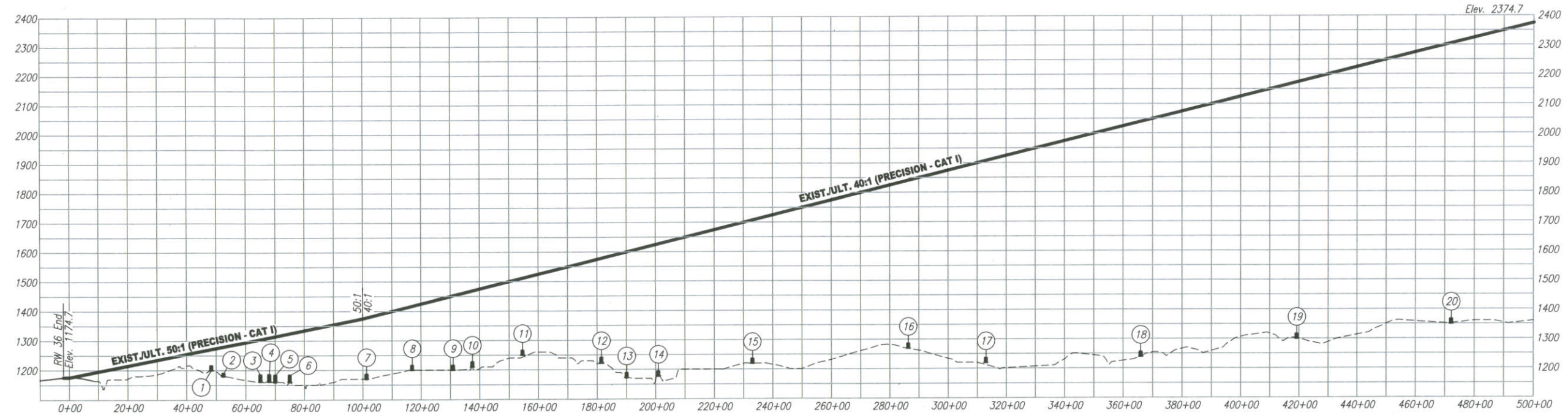

RUNWAY 36 END

| OBSTRUCTION TABLE | | | | | | |
|-------------------------|------------------|---------------------------|------------------------------|---------------------------|----------------|----------------------|
| OBJECT NO./ DESCRIPTION | OBJECT ELEVATION | PART 77 SURFACE ELEVATION | PART 77 SURFACE OBJECT IS IN | OBJECT PENETRATION | | PROPOSED DISPOSITION |
| | | | | 'C'=Clears 'OB'=Obstructs | | |
| | | | | 'C'=Clears | 'OB'=Obstructs | |
| 1 Private Road | 1203.6 | 1308.3 | 50:1 APP. SLOPE | 104.7 | 'C' | |
| 2 Highway 34 | 1228.4 | 1311.3 | 50:1 APP. SLOPE | 82.9 | 'C' | |
| 3 UP Railroad | 1211.0 | 1455.6 | 40:1 APP. SLOPE | 244.6 | 'C' | |
| 4 W. McKelvie Road | 1215.0 | 1485.0 | 40:1 APP. SLOPE | 270.0 | 'C' | |
| 5 W. Bluff Road | 1215.0 | 1617.8 | 40:1 APP. SLOPE | 402.8 | 'C' | |
| 6 W. Waverly Road | 1225.0 | 1753.1 | 40:1 APP. SLOPE | 528.1 | 'C' | |
| 7 W. Mill Road | 1265.0 | 1885.4 | 40:1 APP. SLOPE | 620.4 | 'C' | |
| 8 W. Raymond Road | 1325.0 | 2013.2 | 40:1 APP. SLOPE | 688.2 | 'C' | |
| 9 Branched Oak Rd | 1315.0 | 2145.5 | 40:1 APP. SLOPE | 830.5 | 'C' | |
| 10 W. Davey Road | 1245.0 | 2266.2 | 40:1 APP. SLOPE | 1021.2 | 'C' | |

| OBSTRUCTION TABLE | | | | | | |
|-------------------------|------------------|---------------------------|------------------------------|---------------------------|----------------|----------------------|
| OBJECT NO./ DESCRIPTION | OBJECT ELEVATION | PART 77 SURFACE ELEVATION | PART 77 SURFACE OBJECT IS IN | OBJECT PENETRATION | | PROPOSED DISPOSITION |
| | | | | 'C'=Clears 'OB'=Obstructs | | |
| | | | | 'C'=Clears | 'OB'=Obstructs | |
| 1 West O St. | 1215.0 | 1271.1 | 50:1 APP. SLOPE | 56.1 | 'C' | |
| 2 Private Road | 1190.0 | 1279.7 | 50:1 APP. SLOPE | 89.7 | 'C' | |
| 3 BN Railroad | 1184.5 | 1304.6 | 50:1 APP. SLOPE | 120.1 | 'C' | |
| 4 BN Railroad | 1185.0 | 1310.6 | 50:1 APP. SLOPE | 125.6 | 'C' | |
| 5 BN Railroad | 1183.0 | 1314.7 | 50:1 APP. SLOPE | 131.7 | 'C' | |
| 6 BN Railroad | 1183.0 | 1324.6 | 50:1 APP. SLOPE | 141.6 | 'C' | |
| 7 W. A Street | 1185.0 | 1378.0 | 40:1 APP. SLOPE | 193.0 | 'C' | |
| 8 Public Road | 1215.0 | 1417.1 | 40:1 APP. SLOPE | 202.1 | 'C' | |
| 9 Public Road | 1215.0 | 1452.0 | 40:1 APP. SLOPE | 237.0 | 'C' | |
| 10 Public Road | 1226.0 | 1468.5 | 40:1 APP. SLOPE | 242.5 | 'C' | |
| 11 W. Van Dom St. | 1265.0 | 1511.1 | 40:1 APP. SLOPE | 246.1 | 'C' | |
| 12 Pioneer Park Rd. | 1240.0 | 1578.3 | 40:1 APP. SLOPE | 338.3 | 'C' | |
| 13 Pioneer Park Rd. | 1187.5 | 1615.2 | 40:1 APP. SLOPE | 427.7 | 'C' | |
| 14 Bn Railroad | 1193.0 | 1626.9 | 40:1 APP. SLOPE | 433.9 | 'C' | |
| 15 W. Claire Ave | 1235.0 | 1707.2 | 40:1 APP. SLOPE | 472.2 | 'C' | |
| 16 W. Pleasant Hill Rd. | 1285.0 | 1840.5 | 40:1 APP. SLOPE | 555.5 | 'C' | |
| 17 W. Denton Rd. | 1235.0 | 1907.2 | 40:1 APP. SLOPE | 672.2 | 'C' | |
| 18 Yankee Hill Rd. | 1255.0 | 2039.4 | 40:1 APP. SLOPE | 784.4 | 'C' | |
| 19 W. Rokeby Rd. | 1315.0 | 2172.6 | 40:1 APP. SLOPE | 857.6 | 'C' | |
| 20 W. Sanilo Rd. | 1365.0 | 2305.1 | 40:1 APP. SLOPE | 940.1 | 'C' | |

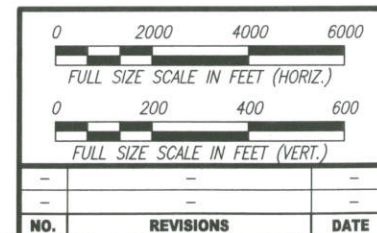

FA:Transportation_367049(4) Sheet 5 of 25.dwg

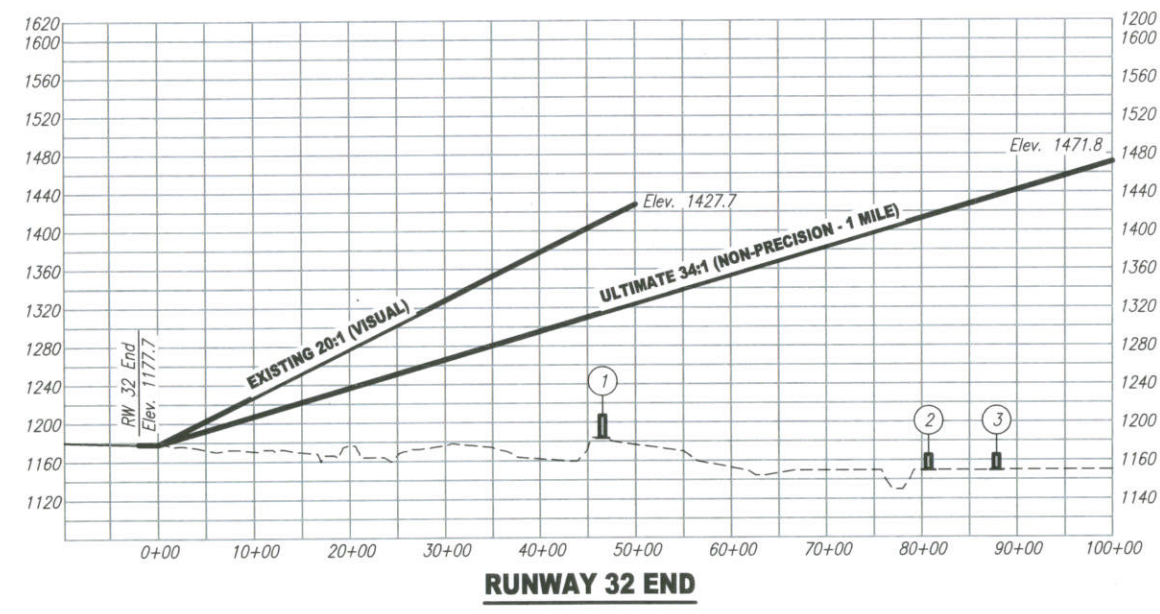
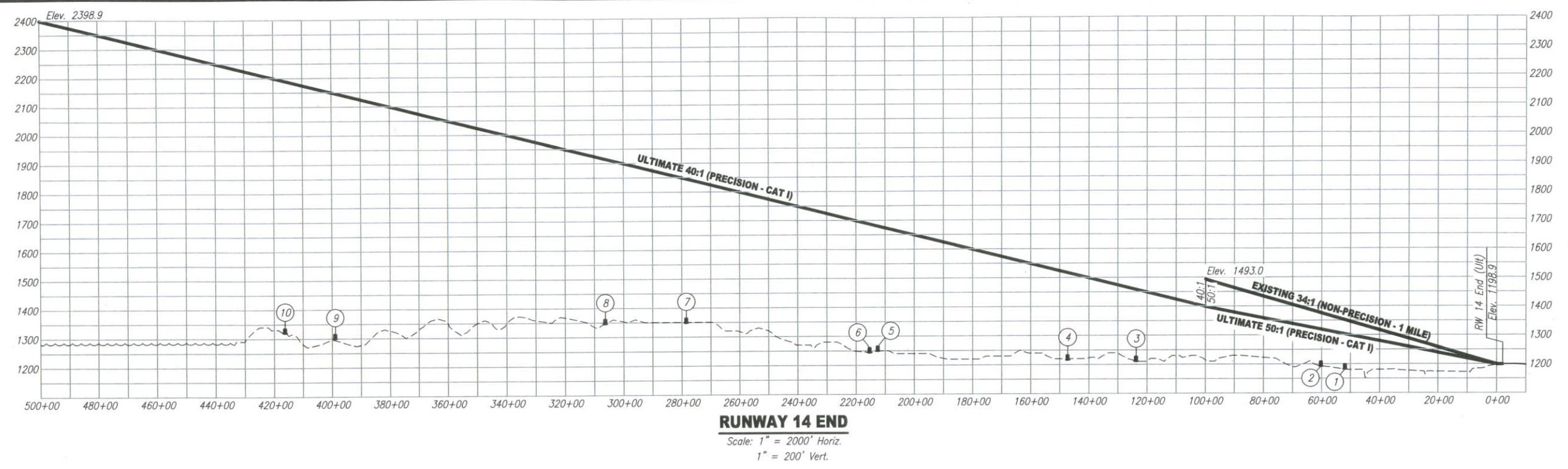

| OBSTRUCTION TABLE | | | | | RUNWAY 14 END (Ultimate) 50:1 | |
|---------------------------|---------------------|------------------------------|---------------------------------|--------------------|-------------------------------|-------------------------|
| OBJECT NO/ DESCRIPTION | OBJECT ELEVATION | PART 77 SURFACE ELEVATION | PART 77 SURFACE OBJECT IS IN | OBJECT PENETRATION | | PROPOSED DISPOSITION |
| | | | | 'C'=Clears | 'OB'=Obstructs | |
| 1 | NW 48th Street | 1198.0 | PRIMARY SURFACE | 0.9 | 'C' | |
| 2 | Highway 34 | 1208.0 | 50:1 APP. SLOPE | 111.4 | 'C' | |
| 3 | NE Highway 79 | 1226.6 | 40:1 APP. SLOPE | 231.9 | 'C' | |
| 4 | W. McKelvie Road | 1232.0 | 40:1 APP. SLOPE | 285.3 | 'C' | |
| 5 | W. Bluff Road | 1265.0 | 40:1 APP. SLOPE | 415.5 | 'C' | |
| 6 | NW 70th Street | 1260.0 | 40:1 APP. SLOPE | 427.5 | 'C' | |
| 7 | W. Waverly Road | 1365.0 | 40:1 APP. SLOPE | 480.2 | 'C' | |
| 8 | NW 84th Street | 1361.0 | 40:1 APP. SLOPE | 553.8 | 'C' | |
| 9 | NW 98th Street | 1315.0 | 40:1 APP. SLOPE | 831.5 | 'C' | |
| 10 | W. Raymond Road | 1335.0 | 40:1 APP. SLOPE | 854.7 | 'C' | |

| OBSTRUCTION TABLE | | | | RUNWAY 32 END (Ultimate) 34:1 | | |
|---------------------------|---------------------|------------------------------|---------------------------------|-------------------------------|----------------|-------------------------|
| OBJECT NO/ DESCRIPTION | OBJECT ELEVATION | PART 77 SURFACE ELEVATION | PART 77 SURFACE OBJECT IS IN | OBJECT PENETRATION | | PROPOSED DISPOSITION |
| | | | | 'C'=Clears | 'OB'=Obstructs | |
| 1 | Interstate 80 | 1207.0 | 34:1 APP. SURFACE | 107.5 | 'C' | |
| 2 | Public Road | 1165.0 | 34:1 APP. SURFACE | 250.1 | 'C' | |
| 3 | Public Road | 1165.0 | 34:1 APP. SURFACE | 271.1 | 'C' | |
| 4 | Public Road | 1155.0 | 34:1 APP. SURFACE | 225.1 | 'C' | |
| 5 | Public Road | 1155.0 | 34:1 APP. SURFACE | 246.9 | 'C' | |
| 6 | Lake Drive | 1165.0 | 34:1 APP. SURFACE | 243.3 | 'C' | |
| 7 | BN Railroad | 1174.0 | 34:1 APP. SURFACE | 238.8 | 'C' | |
| 8 | Oakcreek Drive | 1165.0 | 34:1 APP. SURFACE | 280.2 | 'C' | |
| 9 | Sun Valley Blvd | 1165.0 | 34:1 APP. SURFACE | 301.2 | 'C' | |
| 10 | W. O Street | 1163.5 | 34:1 APP. SURFACE | 339.3 | 'C' | |
| 11 | N Street | 1159.0 | 34:1 APP. SURFACE | 356.4 | 'C' | |
| 12 | S. 2nd Street | 1159.0 | 34:1 APP. SURFACE | 361.9 | 'C' | |
| 13 | M Street | 1159.0 | 34:1 APP. SURFACE | 368.2 | 'C' | |
| 14 | UP/BN Railroad | 1173.0 | 34:1 APP. SURFACE | 370.2 | 'C' | |
| 15 | UP/BN Railroad | 1174.0 | 34:1 APP. SURFACE | 378.8 | 'C' | |
| 16 | BN Railroad | 1173.0 | 34:1 APP. SURFACE | 384.6 | 'C' | |
| 17 | Capitol Pkwy W | 1165.0 | 34:1 APP. SURFACE | 400.5 | 'C' | |
| 18 | BN Railroad | 1173.0 | 34:1 APP. SURFACE | 398.9 | 'C' | |
| 19 | BN Railroad | 1173.0 | 34:1 APP. SURFACE | 403.6 | 'C' | |
| 20 | S. 6th Street | 1165.0 | 34:1 APP. SURFACE | 426.0 | 'C' | |
| 21 | D Street | 1189.0 | 34:1 APP. SURFACE | 437.5 | 'C' | |
| 22 | C Street | 1177.4 | 34:1 APP. SURFACE | 461.3 | 'C' | |
| 23 | N 9th Street | 1179.4 | 34:1 APP. SURFACE | 465.2 | 'C' | |
| 24 | B Street | 1178.0 | 34:1 APP. SURFACE | 473.0 | 'C' | |
| 25 | A Street | 1183.7 | 34:1 APP. SURFACE | 478.7 | 'C' | |

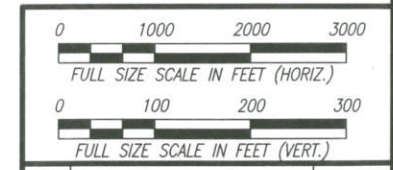

| NO. | REVISIONS | DATE |
|-----|-----------|------|
| | | |

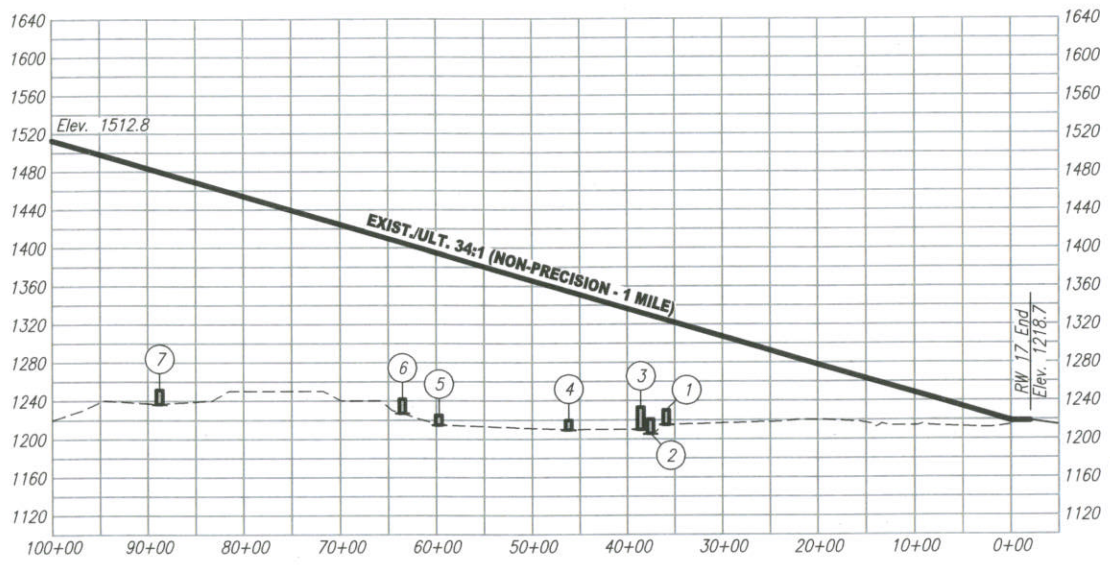

RUNWAY 17 END

| OBSTRUCTION TABLE | | | | RUNWAY 17 END (Exist./Ult.) 34:1 | | |
|-------------------------|------------------|---------------------------|------------------------------|----------------------------------|----------------|----------------------|
| OBJECT NO./ DESCRIPTION | OBJECT ELEVATION | PART 77 SURFACE ELEVATION | PART 77 SURFACE OBJECT IS IN | OBJECT PENETRATION | | PROPOSED DISPOSITION |
| | | | | 'C'=Clears | 'OB'=Obstructs | |
| 1 W. Fletcher St. | 1230.0 | 1324.2 | 34:1 APP. SURFACE | 94.2 | 'C' | |
| 2 Private Road | 1220.5 | 1329.1 | 34:1 APP. SURFACE | 108.6 | 'C' | |
| 3 Kawasaki Railroad | 1233.0 | 1332.1 | 34:1 APP. SURFACE | 99.1 | 'C' | |
| 4 Private Road | 1219.5 | 1354.3 | 34:1 APP. SURFACE | 134.8 | 'C' | |
| 5 Private Road | 1225.0 | 1394.2 | 34:1 APP. SURFACE | 169.2 | 'C' | |
| 6 Highway 34 | 1242.0 | 1405.4 | 34:1 APP. SURFACE | 163.4 | 'C' | |
| 7 W. Alvo Road | 1251.5 | 1479.8 | 34:1 APP. SURFACE | 228.3 | 'C' | |

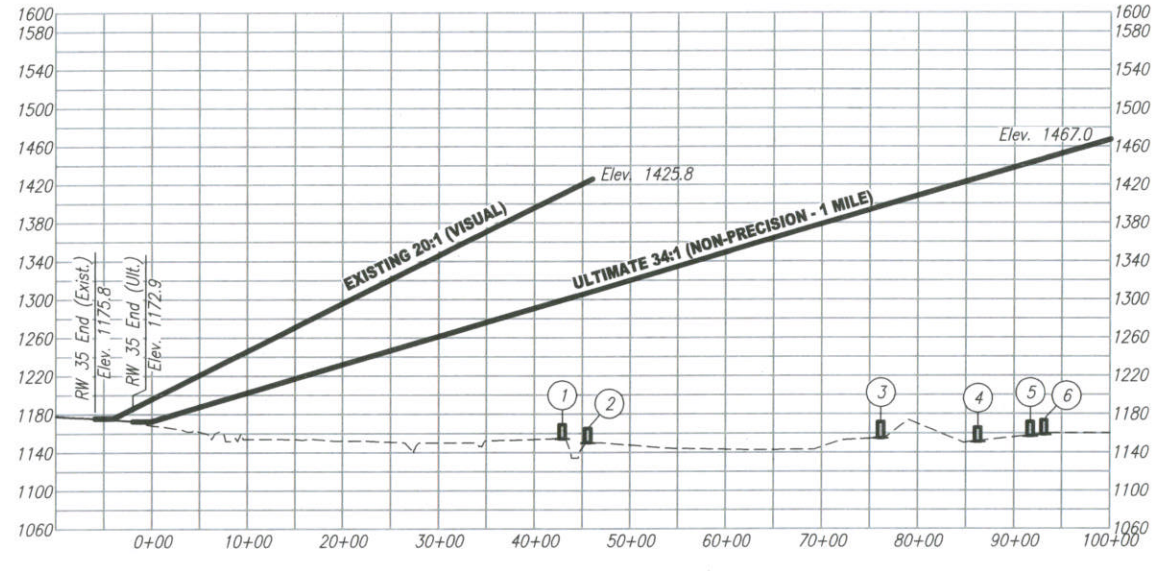

RUNWAY 35 END

| OBSTRUCTION TABLE | | | | RUNWAY 35 END (Ultimate) 34:1 | | |
|-------------------------|------------------|---------------------------|------------------------------|-------------------------------|----------------|----------------------|
| OBJECT NO./ DESCRIPTION | OBJECT ELEVATION | PART 77 SURFACE ELEVATION | PART 77 SURFACE OBJECT IS IN | OBJECT PENETRATION | | PROPOSED DISPOSITION |
| | | | | 'C'=Clears | 'OB'=Obstructs | |
| 1 Gravel Road | 1169.4 | 1172.9 | PRIMARY SURFACE | 3.5 | 'C' | |
| 2 Gravel Road | 1165.1 | 1306.9 | 34:1 APP. SURFACE | 141.8 | 'C' | |
| 3 Interstate 80 | 1172.0 | 1396.9 | 34:1 APP. SURFACE | 224.9 | 'C' | |
| 4 W. Lakeshore Dr. | 1166.0 | 1426.5 | 34:1 APP. SURFACE | 260.5 | 'C' | |
| 5 Surfside Dr. | 1171.8 | 1442.6 | 34:1 APP. SURFACE | 270.8 | 'C' | |
| 6 SW 20th St. | 1173.5 | 1446.8 | 34:1 APP. SURFACE | 273.3 | 'C' | |

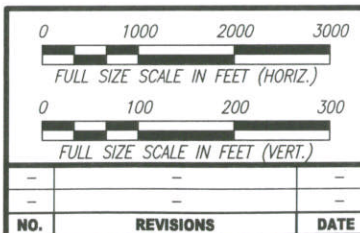

| NO. | REVISIONS | DATE |
|-----|-----------|------|
| - | - | - |
| - | - | - |

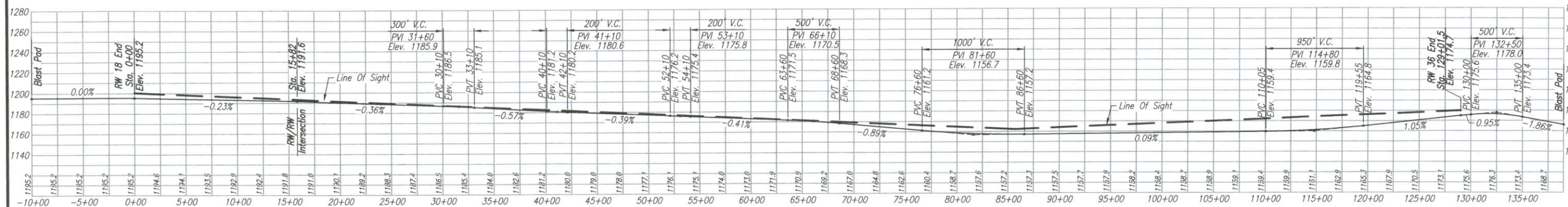

RUNWAY 18/36 PROFILE

Length (Exist/Ult): 12,901.5'

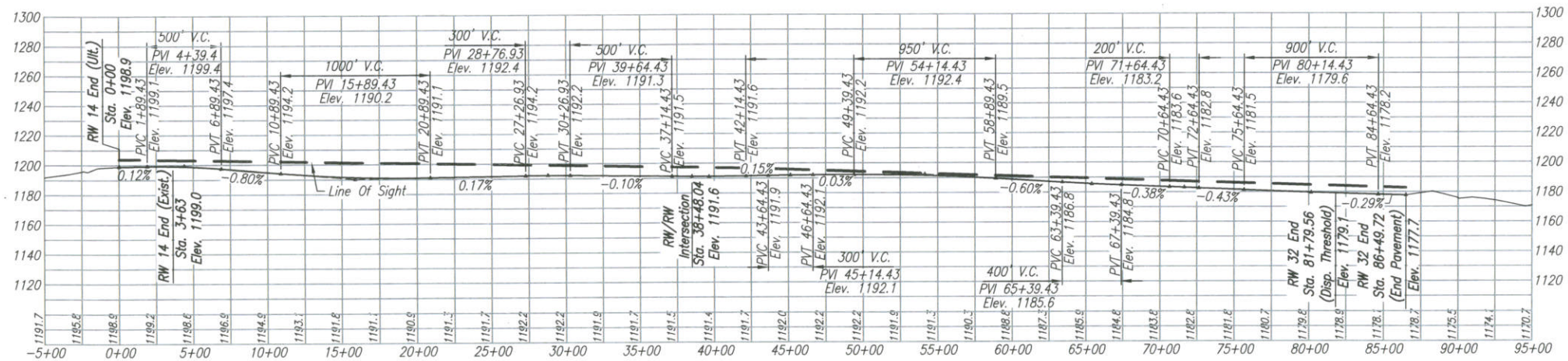

RUNWAY 14/32 PROFILE

Length (Exist/Ult): 8,649.7'

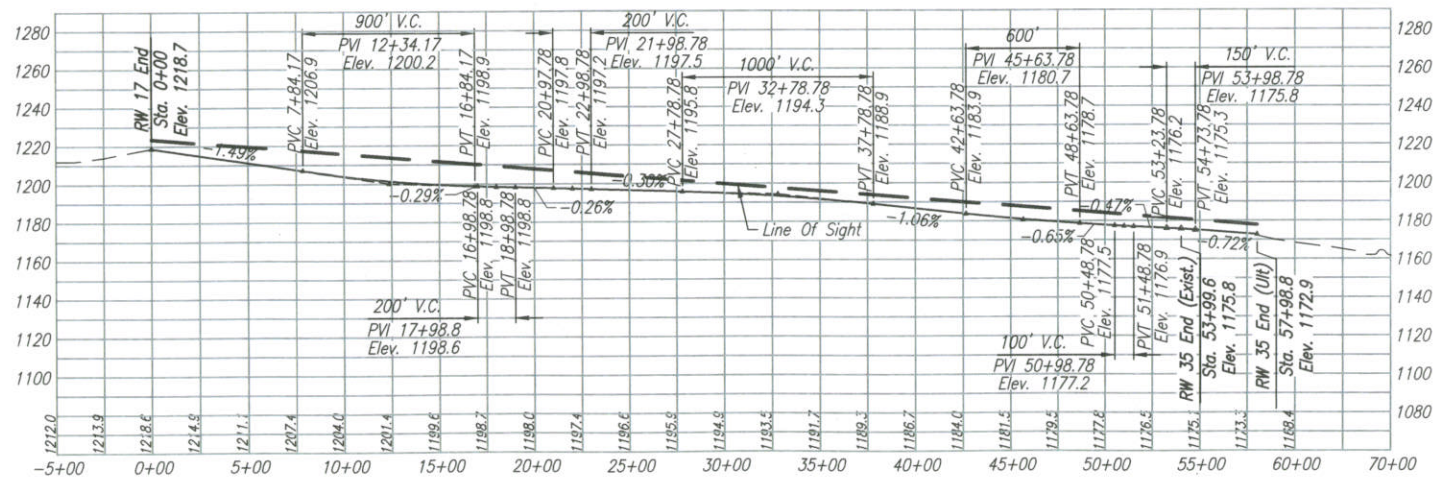

RUNWAY 17/35 PROFILE

Length (Exist): 5,399.6'

Length (Ult): 5,798.7'

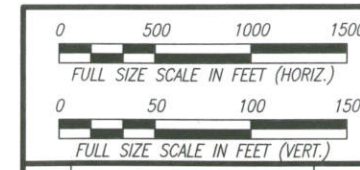

| NO. | REVISIONS | DATE |
|-----|-----------|------|
| - | - | - |

RUNWAY 17/35 LINE OF SIGHT PROFILE
 RUNWAY 14/32 LINE OF SIGHT PROFILE
 RUNWAY 18/36 LINE OF SIGHT PROFILE

LINCOLN AIRPORT
 LINCOLN, NEBRASKA

LINCOLN OFFICE
 825 S. J. St., Box 80358
 Lincoln, NE 68501
 (402) 479-2200
 www.hws.com



| | |
|-----------|-------------|
| PROJECT | ALP |
| DATE | August 2007 |
| JOB NO. | 36-7049 |
| SHEET NO. | 8 |
| | 29 |

F:\Transportation\367049\Sheets\Sheet108.dwg

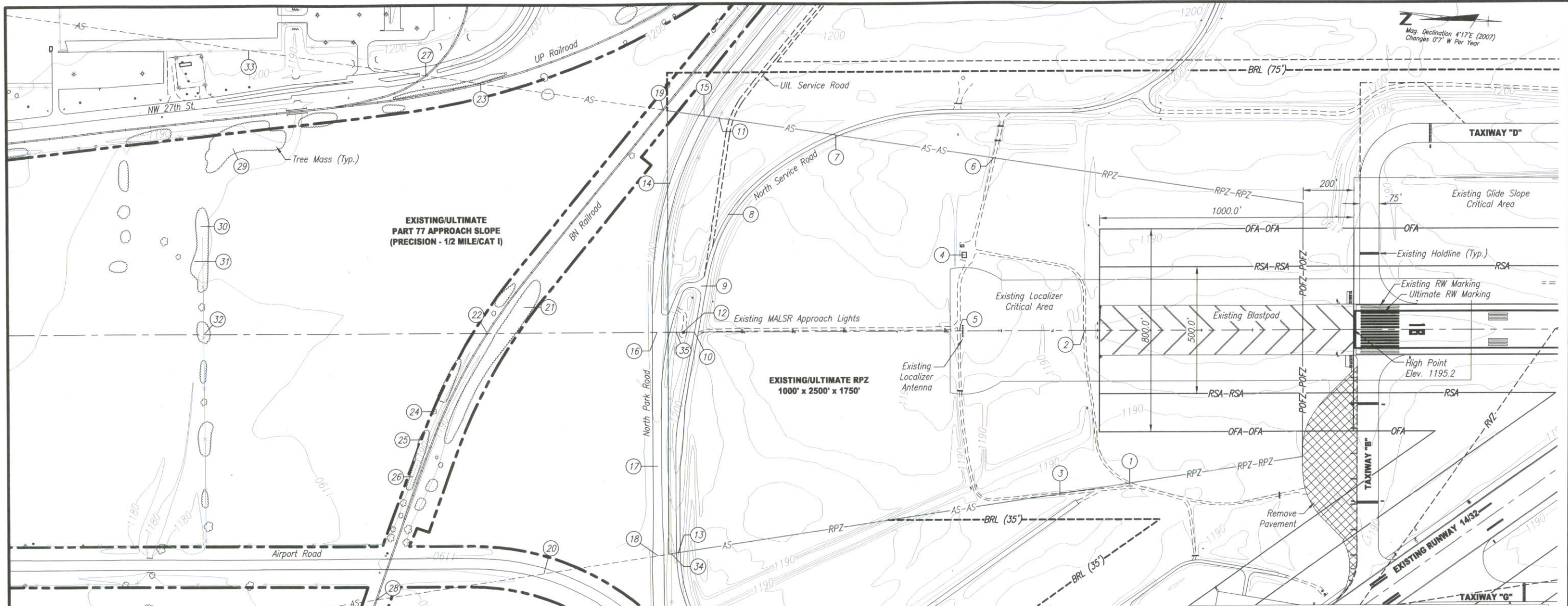

RUNWAY 18 END

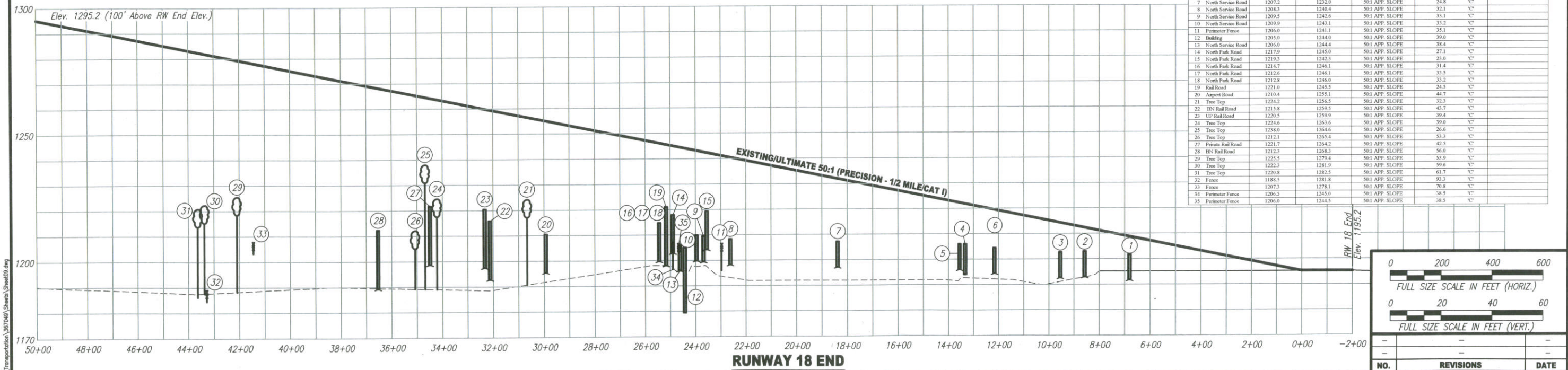

| OBJECT NO./DESCRIPTION | OBJECT ELEVATION | PART 77 SURFACE ELEVATION | PART 77 SURFACE OBJECT IS IN | RUNWAY 18 END (Exist/Ult) 50:1 | | PROPOSED DISPOSITION |
|------------------------|------------------|---------------------------|------------------------------|--------------------------------|--------------------|----------------------|
| | | | | Object Penetration | Object Obstruction | |
| 1 Service Road | 1201.8 | 1208.8 | 50:1 APP. SLOPE | 7.0 | "C" | |
| 2 Service Road | 1203.0 | 1212.4 | 50:1 APP. SLOPE | 9.4 | "C" | |
| 3 Service Road | 1202.7 | 1214.3 | 50:1 APP. SLOPE | 11.6 | "C" | |
| 4 Building | 1206.0 | 1221.9 | 50:1 APP. SLOPE | 15.9 | "C" | |
| 5 Service Road | 1202.7 | 1222.3 | 50:1 APP. SLOPE | 19.6 | "C" | |
| 6 Service Road | 1204.5 | 1219.5 | 50:1 APP. SLOPE | 15.0 | "C" | |
| 7 North Service Road | 1207.2 | 1232.0 | 50:1 APP. SLOPE | 24.8 | "C" | |
| 8 North Service Road | 1208.3 | 1240.4 | 50:1 APP. SLOPE | 32.1 | "C" | |
| 9 North Service Road | 1209.5 | 1242.6 | 50:1 APP. SLOPE | 33.1 | "C" | |
| 10 North Service Road | 1209.9 | 1243.1 | 50:1 APP. SLOPE | 33.2 | "C" | |
| 11 Perimeter Fence | 1206.0 | 1241.1 | 50:1 APP. SLOPE | 35.1 | "C" | |
| 12 Building | 1205.0 | 1244.0 | 50:1 APP. SLOPE | 39.0 | "C" | |
| 13 North Service Road | 1206.0 | 1244.4 | 50:1 APP. SLOPE | 38.4 | "C" | |
| 14 North Park Road | 1217.9 | 1249.6 | 50:1 APP. SLOPE | 27.1 | "C" | |
| 15 North Park Road | 1219.3 | 1242.3 | 50:1 APP. SLOPE | 23.0 | "C" | |
| 16 North Park Road | 1214.7 | 1246.1 | 50:1 APP. SLOPE | 31.4 | "C" | |
| 17 North Park Road | 1212.6 | 1246.1 | 50:1 APP. SLOPE | 33.5 | "C" | |
| 18 North Park Road | 1212.8 | 1246.0 | 50:1 APP. SLOPE | 33.2 | "C" | |
| 19 Rail Road | 1211.0 | 1245.5 | 50:1 APP. SLOPE | 24.5 | "C" | |
| 20 Airport Road | 1210.4 | 1255.1 | 50:1 APP. SLOPE | 44.7 | "C" | |
| 21 Tree Top | 1224.2 | 1256.5 | 50:1 APP. SLOPE | 32.3 | "C" | |
| 22 BN Rail Road | 1215.8 | 1259.5 | 50:1 APP. SLOPE | 43.7 | "C" | |
| 23 UP Rail Road | 1220.5 | 1259.9 | 50:1 APP. SLOPE | 39.4 | "C" | |
| 24 Tree Top | 1224.6 | 1262.6 | 50:1 APP. SLOPE | 39.0 | "C" | |
| 25 Tree Top | 1238.0 | 1264.6 | 50:1 APP. SLOPE | 26.6 | "C" | |
| 26 Tree Top | 1212.1 | 1265.4 | 50:1 APP. SLOPE | 53.3 | "C" | |
| 27 Private Rail Road | 1221.7 | 1264.2 | 50:1 APP. SLOPE | 42.5 | "C" | |
| 28 BN Rail Road | 1212.3 | 1268.3 | 50:1 APP. SLOPE | 56.0 | "C" | |
| 29 Tree Top | 1225.9 | 1279.4 | 50:1 APP. SLOPE | 53.9 | "C" | |
| 30 Tree Top | 1222.3 | 1281.9 | 50:1 APP. SLOPE | 59.6 | "C" | |
| 31 Tree Top | 1220.8 | 1282.5 | 50:1 APP. SLOPE | 61.7 | "C" | |
| 32 Fence | 1188.5 | 1281.8 | 50:1 APP. SLOPE | 93.3 | "C" | |
| 33 Fence | 1207.3 | 1278.1 | 50:1 APP. SLOPE | 70.8 | "C" | |
| 34 Perimeter Fence | 1206.0 | 1245.0 | 50:1 APP. SLOPE | 38.5 | "C" | |
| 35 Perimeter Fence | 1206.0 | 1244.5 | 50:1 APP. SLOPE | 38.5 | "C" | |

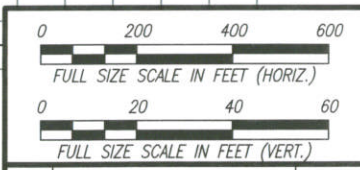

| NO. | REVISIONS | DATE |
|-----|-----------|------|
| | | |

INNER PORTION OF EXIST./ULT. RUNWAY 18 APPROACH SURFACE DRAWING

**LINCOLN AIRPORT
LINCOLN, NEBRASKA**

LINCOLN OFFICE
825 S. J. St., Box 80388
Lincoln, NE 68501
(402) 479-2200
www.hws.com



PROJECT: ALP
DATE: August 2007
JOB NO.: 36-7049
SHEET NO.: 9/29

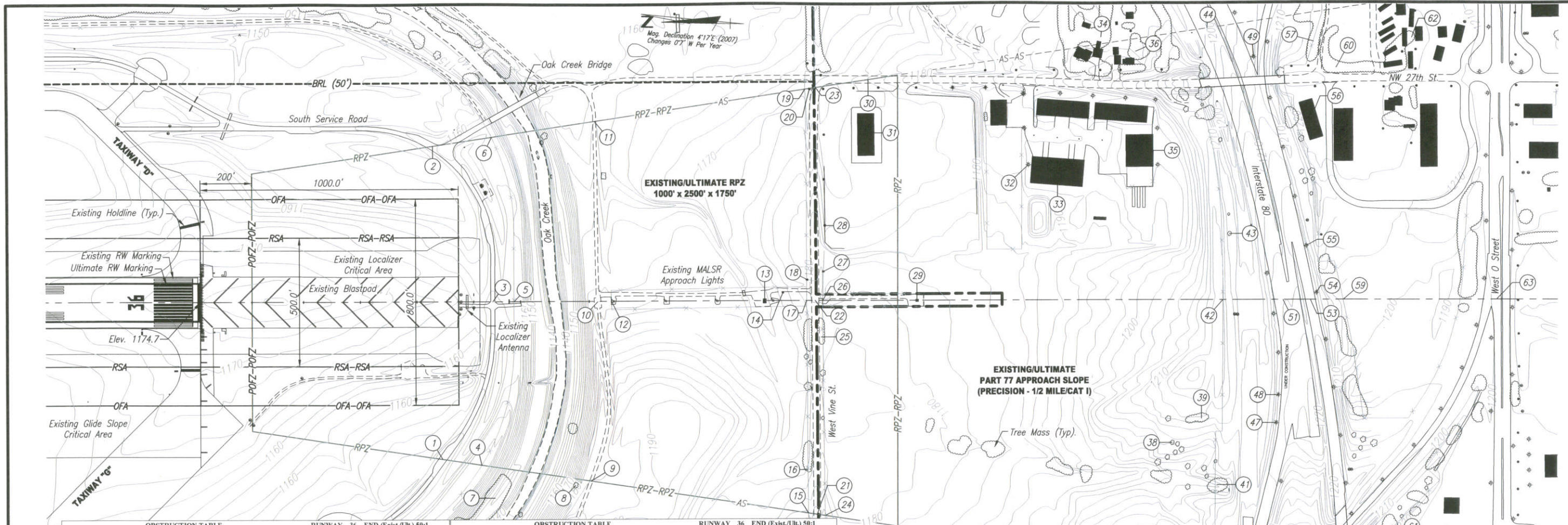

| OBSTRUCTION TABLE | | | | | OBSTRUCTION TABLE | | | | |
|-------------------------|------------------|---------------------------|------------------------------|----------------------|-------------------------|------------------|---------------------------|------------------------------|----------------------|
| OBJECT NO./ DESCRIPTION | OBJECT ELEVATION | PART 77 SURFACE ELEVATION | PART 77 SURFACE OBJECT IS IN | PROPOSED DISPOSITION | OBJECT NO./ DESCRIPTION | OBJECT ELEVATION | PART 77 SURFACE ELEVATION | PART 77 SURFACE OBJECT IS IN | PROPOSED DISPOSITION |
| 1 South Service Road | 1181.5 | 1189.4 | 50:1 APP. SLOPE | 7.9 °C | 30 NW 27th St | 1190.9 | 1222.4 | 50:1 APP. SLOPE | 31.5 °C |
| 2 South Service Road | 1169.6 | 1188.7 | 50:1 APP. SLOPE | 19.1 °C | 31 Building | 1198.4 | 1222.2 | 50:1 APP. SLOPE | 23.8 °C |
| 3 South Service Road | 1175.2 | 1193.4 | 50:1 APP. SLOPE | 18.2 °C | 32 Light Pole | 1220.1 | 1234.8 | 50:1 APP. SLOPE | 14.5 °C |
| 4 Perimeter Fence | 1185.0 | 1192.5 | 50:1 APP. SLOPE | 7.5 °C | 33 Building | 1228.6 | 1237.1 | 50:1 APP. SLOPE | 8.5 °C |
| 5 Perimeter Fence | 1173.9 | 1195.0 | 50:1 APP. SLOPE | 21.1 °C | 34 Tree Top | 1247.0 | 1244.4 | 7:1 TRANS. SURFACE | -2.6 °OB |
| 6 Perimeter Fence | 1170.2 | 1193.3 | 50:1 APP. SLOPE | 23.1 °C | 35 Building | 1228.5 | 1243.4 | 50:1 APP. SLOPE | 14.9 °C |
| 7 Tree Top | 1192.3 | 1210.6 | 7:1 TRANS. SURFACE | 18.3 °C | 36 Tree Top | 1243.6 | 1243.1 | 50:1 APP. SLOPE | -0.5 °OB |
| 8 Tree Top | 1197.9 | 1203.3 | 7:1 TRANS. SURFACE | 5.4 °C | 37 Tree Top | 1254.4 | 1257.6 | 7:1 TRANS. SURFACE | 3.2 °C |
| 9 Private Road | 1196.8 | 1200.0 | 50:1 APP. SLOPE | 4.1 °C | 38 Tree Top | 1224.2 | 1246.0 | 50:1 APP. SLOPE | 21.8 °C |
| 10 Private Road | 1179.5 | 1201.5 | 50:1 APP. SLOPE | 22.0 °C | 39 Tree Top | 1236.7 | 1248.2 | 50:1 APP. SLOPE | 11.5 °C |
| 11 Private Road | 1171.9 | 1201.2 | 50:1 APP. SLOPE | 29.3 °C | 40 Fence | 1210.0 | 1249.3 | 50:1 APP. SLOPE | 39.3 °C |
| 12 Fence | 1175.4 | 1202.5 | 50:1 APP. SLOPE | 27.1 °C | 41 Tree Top | 1247.3 | 1249.5 | 50:1 APP. SLOPE | 2.2 °C |
| 13 Building | 1182.9 | 1214.4 | 50:1 APP. SLOPE | 31.5 °C | 42 Fence | 1218.0 | 1249.9 | 50:1 APP. SLOPE | 31.9 °C |
| 14 Utility Pole | 1198.8 | 1215.8 | 50:1 APP. SLOPE | 17.0 °C | 43 Tree Top | 1229.6 | 1250.4 | 50:1 APP. SLOPE | 20.8 °C |
| 15 Fence | 1188.5 | 1217.8 | 50:1 APP. SLOPE | 29.3 °C | 44 Interstate 80 | 1217.0 | 1248.6 | 50:1 APP. SLOPE | 31.6 °C |
| 16 Tree Top | 1224.7 | 1217.8 | 50:1 APP. SLOPE | -6.9 °OB | 45 Interstate 80 | 1231.7 | 1252.0 | 50:1 APP. SLOPE | 20.3 °C |
| 17 Fence | 1187.1 | 1217.7 | 50:1 APP. SLOPE | 30.6 °C | 46 Light Pole | 1247.8 | 1258.4 | 7:1 TRANS. SURFACE | 10.6 °C |
| 18 Utility Pole | 1209.0 | 1217.7 | 50:1 APP. SLOPE | 8.7 °C | 47 Light Pole | 1245.7 | 1254.0 | 50:1 APP. SLOPE | 8.3 °C |
| 19 Fence | 1174.6 | 1217.6 | 50:1 APP. SLOPE | 43.0 °C | 48 Light Pole | 1245.8 | 1254.2 | 50:1 APP. SLOPE | 8.4 °C |
| 20 Utility Pole | 1197.3 | 1217.9 | 50:1 APP. SLOPE | 20.6 °C | 49 Light Pole | 1256.0 | 1252.2 | 50:1 APP. SLOPE | -3.8 °OB |
| 21 W. Vine St. | 1199.5 | 1218.5 | 50:1 APP. SLOPE | 19.0 °C | 50 Light Pole | 1235.8 | 1255.4 | 50:1 APP. SLOPE | 19.6 °C |
| 22 W. Vine St. | 1195.0 | 1218.3 | 50:1 APP. SLOPE | 23.3 °C | 51 Interstate 80 | 1223.0 | 1254.5 | 50:1 APP. SLOPE | 31.5 °C |
| 23 W. Vine St. | 1187.0 | 1218.4 | 50:1 APP. SLOPE | 31.4 °C | 52 West O St. | 1222.1 | 1255.8 | 50:1 APP. SLOPE | 33.7 °C |
| 24 Fence | 1189.0 | 1219.1 | 50:1 APP. SLOPE | 30.1 °C | 53 Interstate 80 | 1232.2 | 1256.7 | 50:1 APP. SLOPE | 24.5 °C |
| 25 Tree Top | 1202.7 | 1218.8 | 50:1 APP. SLOPE | 16.1 °C | 54 Light Pole | 1262.9 | 1257.1 | 50:1 APP. SLOPE | -5.8 °OB |
| 26 Fence | 1184.8 | 1218.9 | 50:1 APP. SLOPE | 34.1 °C | 55 Light Pole | 1262.5 | 1256.3 | 50:1 APP. SLOPE | -6.2 °OB |
| 27 Utility Pole | 1215.8 | 1219.0 | 50:1 APP. SLOPE | 3.2 °C | 56 Building | 1249.6 | 1256.7 | 50:1 APP. SLOPE | 7.1 °C |
| 28 Utility Pole | 1206.1 | 1219.1 | 50:1 APP. SLOPE | 13.0 °C | 57 Tree Top | 1252.9 | 1256.9 | 50:1 APP. SLOPE | 4.0 °C |
| 29 Building | 1191.6 | 1226.2 | 50:1 APP. SLOPE | 34.6 °C | 58 Interstate 80 | 1238.5 | 1259.4 | 50:1 APP. SLOPE | 20.9 °C |
| | | | | | 59 Fence | 1211.0 | 1259.2 | 50:1 APP. SLOPE | 48.2 °C |
| | | | | | 60 Tree Top | 1264.7 | 1258.6 | 50:1 APP. SLOPE | -6.1 °OB |
| | | | | | 61 Tree Top | 1255.2 | 1263.1 | 50:1 APP. SLOPE | 7.9 °C |
| | | | | | 62 Tree Top | 1272.0 | 1264.5 | 50:1 APP. SLOPE | -7.5 °OB |
| | | | | | 63 West O St. | 1215.0 | 1271.1 | 50:1 APP. SLOPE | 56.1 °C |

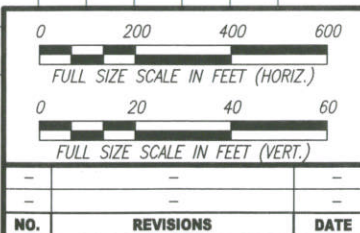
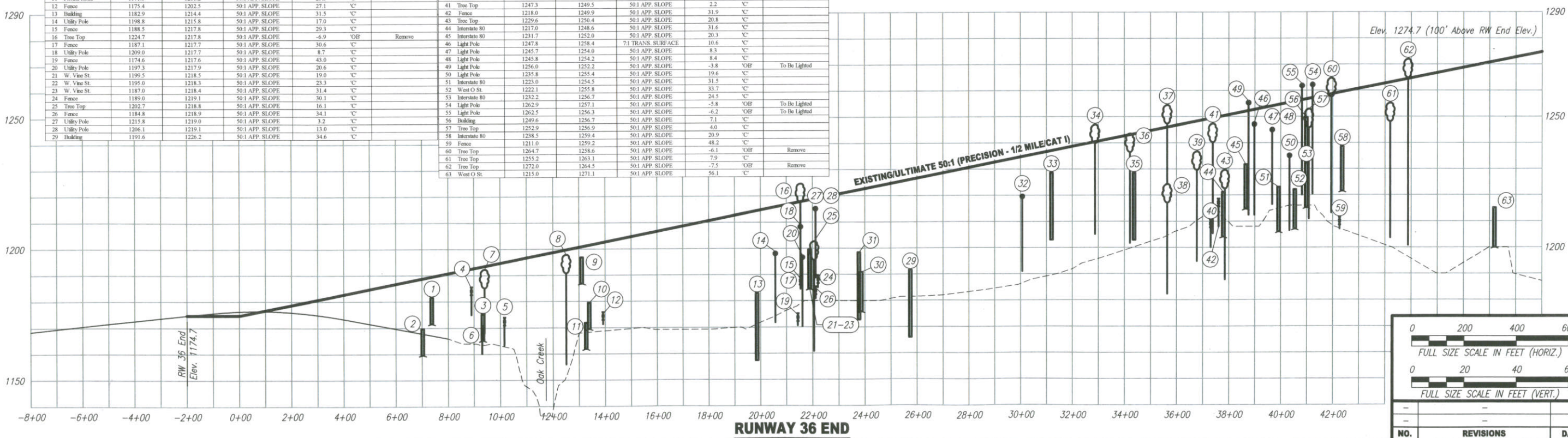

E:\Transportation\367049\Sheet\Sheet10.dwg

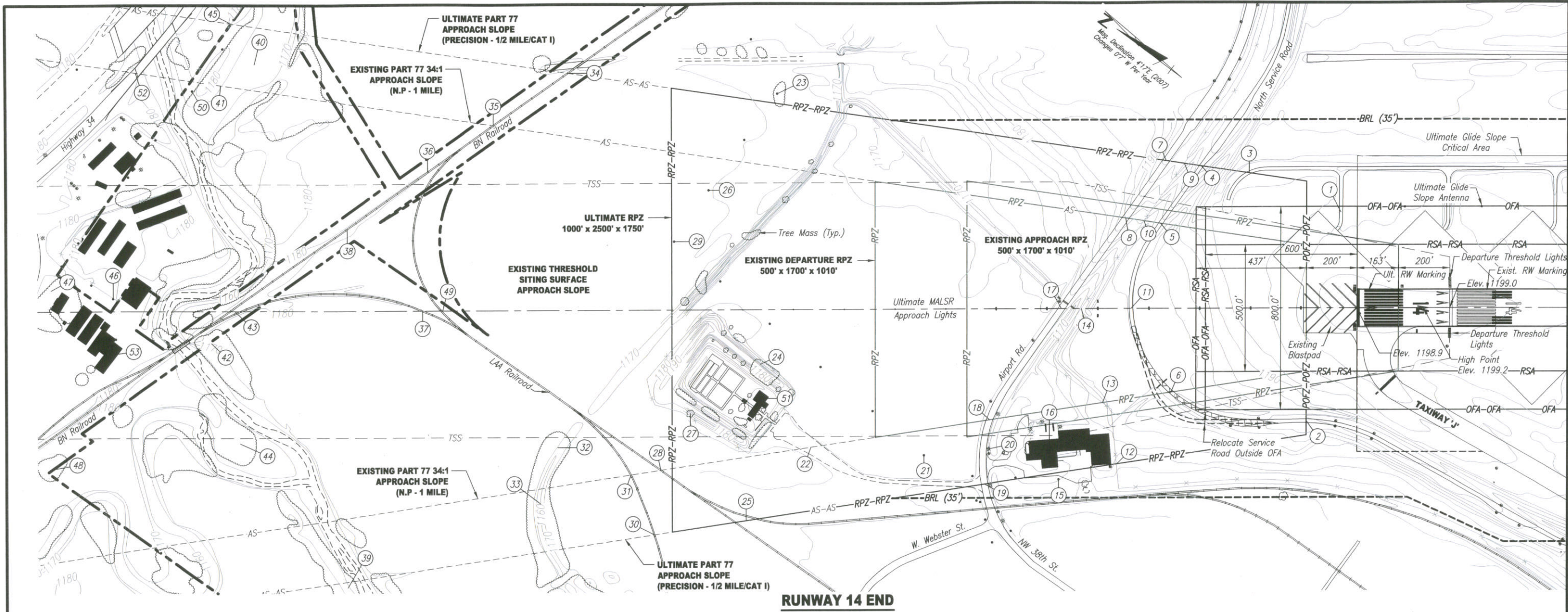

RUNWAY 14 END

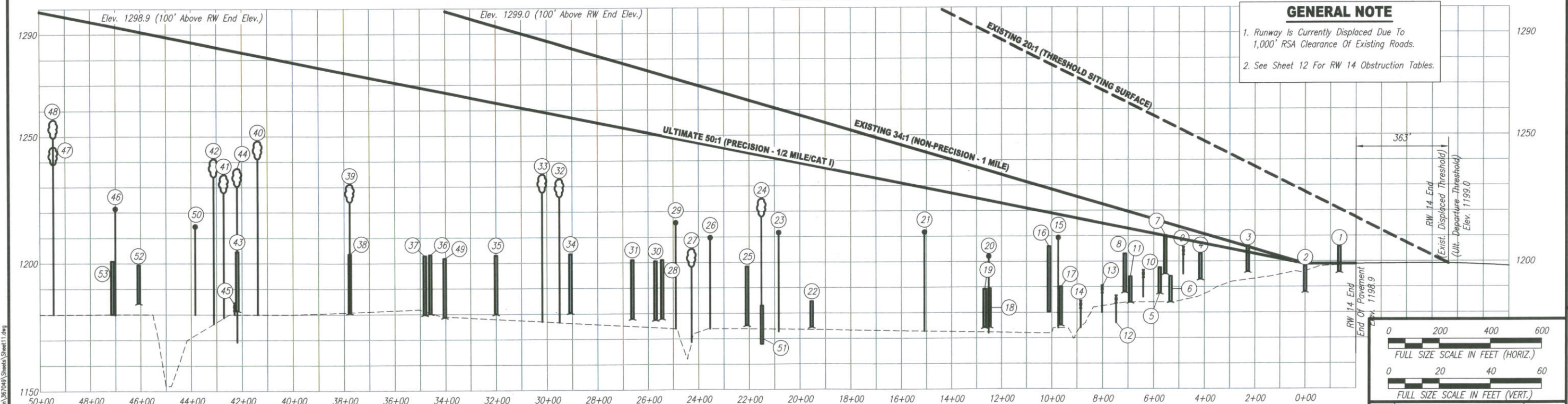

RUNWAY 14 END

GENERAL NOTE
 1. Runway is currently displaced due to 1,000' RSA clearance of existing roads.
 2. See Sheet 12 for RW 14 obstruction tables.

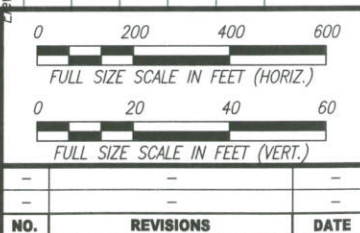

LINCOLN OFFICE
 825 J St., Box 80308
 Lincoln, NE 68501
 (402) 479-2200
 www.hms.com



PROJECT: ALP
 DATE: August 2007
 JOB NO.: 36-7049
 SHEET NO.: 11/29

E:\Transportation\367049\Sheet\Sheet11.dwg

| OBSTRUCTION TABLE | | | | RUNWAY 14 END (Existing) 34:1 | | |
|-------------------------|------------------|---------------------------|------------------------------|-------------------------------|----------------|----------------------|
| OBJECT NO./ DESCRIPTION | OBJECT ELEVATION | PART 77 SURFACE ELEVATION | PART 77 SURFACE OBJECT IS IN | OBJECT PENETRATION | | PROPOSED DISPOSITION |
| | | | | 'C'=Clears | 'OB'=Obstructs | |
| 1 Service Road | 1205.7 | 1216.1 | 7:1 TRANS. SURFACE | 10.4 | 'C' | - |
| 2 North Service Road | 1198.0 | 1226.7 | 7:1 TRANS. SURFACE | 28.7 | 'C' | - |
| 3 Service Road | 1205.9 | 1241.4 | 7:1 TRANS. SURFACE | 35.5 | 'C' | - |
| 4 North Service Road | 1203.0 | 1246.9 | 7:1 TRANS. SURFACE | 43.9 | 'C' | - |
| 5 North Service Road | 1197.5 | 1215.9 | 34:1 APP. SURFACE | 18.4 | 'C' | - |
| 6 North Service Road | 1194.1 | 1214.7 | 34:1 APP. SURFACE | 20.5 | 'C' | - |
| 7 Airport Road | 1210.2 | 1251.0 | 7:1 TRANS. SURFACE | 40.8 | 'C' | - |
| 8 Airport Road | 1203.0 | 1220.0 | 34:1 APP. SURFACE | 17.0 | 'C' | - |
| 9 Perimeter Fence | 1205.0 | 1248.9 | 7:1 TRANS. SURFACE | 43.9 | 'C' | - |
| 10 Perimeter Fence | 1196.0 | 1217.9 | 34:1 APP. SURFACE | 21.9 | 'C' | - |
| 11 North Service Road | 1194.0 | 1219.3 | 34:1 APP. SURFACE | 25.3 | 'C' | - |
| 12 Perimeter Fence | 1186.0 | 1256.7 | 7:1 TRANS. SURFACE | 70.7 | 'C' | - |
| 13 Perimeter Fence | 1190.0 | 1222.6 | 34:1 APP. SURFACE | 32.6 | 'C' | - |
| 14 Perimeter Fence | 1184.0 | 1225.1 | 34:1 APP. SURFACE | 41.1 | 'C' | - |
| 15 Utility Pole | 1210.1 | 1267.2 | 7:1 TRANS. SURFACE | 57.1 | 'C' | - |
| 16 Building | 1205.9 | 1249.1 | 7:1 TRANS. SURFACE | 43.2 | 'C' | - |
| 17 Airport Road | 1190.1 | 1227.4 | 34:1 APP. SURFACE | 37.3 | 'C' | - |
| 18 Airport Road | 1189.4 | 1235.7 | 34:1 APP. SURFACE | 46.3 | 'C' | - |
| 19 Airport Road | 1189.2 | 1272.0 | 7:1 TRANS. SURFACE | 82.8 | 'C' | - |
| 20 Light Pole | 1202.8 | 1252.2 | 7:1 TRANS. SURFACE | 49.4 | 'C' | - |
| 21 Utility Pole | 1212.4 | 1257.7 | 7:1 TRANS. SURFACE | 45.3 | 'C' | - |
| 22 Private Road | 1184.5 | 1256.5 | 34:1 APP. SURFACE | 72.0 | 'C' | - |
| 23 Utility Pole | 1212.4 | 1301.6 | 7:1 TRANS. SURFACE | 89.2 | 'C' | - |
| 24 Tree Top | 1225.0 | 1262.3 | 34:1 APP. SURFACE | 37.3 | 'C' | - |
| 25 LAA Railroad | 1198.3 | 1299.7 | 7:1 TRANS. SURFACE | 101.4 | 'C' | - |
| 26 Utility Pole | 1210.5 | 1268.2 | 34:1 APP. SURFACE | 57.7 | 'C' | - |
| 27 Tree Top | 1205.4 | 1270.4 | 34:1 APP. SURFACE | 65.0 | 'C' | - |
| 28 LAA Railroad | 1201.0 | 1273.8 | 34:1 APP. SURFACE | 72.8 | 'C' | - |
| 29 Utility Pole | 1216.4 | 1272.2 | 34:1 APP. SURFACE | 55.8 | 'C' | - |
| 30 LAA Railroad | 1200.5 | 1310.3 | 7:1 TRANS. SURFACE | 109.8 | 'C' | - |
| 31 LAA Railroad | 1201.0 | 1277.3 | 34:1 APP. SURFACE | 76.3 | 'C' | - |
| 32 Tree Top | 1232.9 | 1285.8 | 34:1 APP. SURFACE | 52.9 | 'C' | - |
| 33 Tree Top | 1234.7 | 1296.3 | 7:1 TRANS. SURFACE | 61.6 | 'C' | - |
| 34 BN Railroad | 1203.4 | 1320.2 | 7:1 TRANS. SURFACE | 116.8 | 'C' | - |
| 35 BN Railroad | 1203.0 | 1293.1 | 34:1 APP. SURFACE | 90.1 | 'C' | - |
| 36 BN Railroad | 1203.2 | 1300.8 | 34:1 APP. SURFACE | 97.6 | 'C' | - |
| 37 LAA Railroad | 1202.8 | 1301.4 | 34:1 APP. SURFACE | 98.6 | 'C' | - |
| 38 BN Railroad | 1203.6 | 1310.1 | 34:1 APP. SURFACE | 106.5 | 'C' | - |
| 39 Tree Top | 1231.1 | 1349.1 | 7:1 TRANS. SURFACE | 118.0 | 'C' | - |
| 40 Tree Top | 1248.2 | 1335.5 | 7:1 TRANS. SURFACE | 87.3 | 'C' | - |
| 41 Tree Top | 1234.9 | 1324.6 | 34:1 APP. SURFACE | 89.7 | 'C' | - |
| 42 Tree Top | 1241.1 | 1325.8 | 34:1 APP. SURFACE | 84.7 | 'C' | - |
| 43 BN Railroad | 1204.5 | 1323.1 | 34:1 APP. SURFACE | 118.6 | 'C' | - |
| 44 Tree Top | 1237.4 | 1322.5 | 34:1 APP. SURFACE | 85.1 | 'C' | - |
| 45 Fence | 1184.0 | 1359.1 | 7:1 TRANS. SURFACE | 175.1 | 'C' | - |
| 46 Utility Pole | 1222.1 | 1337.3 | 34:1 APP. SURFACE | 115.2 | 'C' | - |
| 47 Tree Top | 1246.0 | 1344.5 | 34:1 APP. SURFACE | 98.5 | 'C' | - |
| 48 Tree Top | 1256.5 | 1344.6 | 34:1 APP. SURFACE | 88.1 | 'C' | - |
| 49 LAA Railroad | 1201.7 | 1299.1 | 34:1 APP. SURFACE | 97.4 | 'C' | - |
| 50 Utility Pole | 1215.3 | 1327.9 | 34:1 APP. SURFACE | 112.6 | 'C' | - |
| 51 Building | 1182.9 | 1262.2 | 34:1 APP. SURFACE | 79.3 | 'C' | - |
| 52 Highway 34 | 1199.3 | 1334.5 | 34:1 APP. SURFACE | 135.2 | 'C' | - |
| 53 Building | 1200.8 | 1337.6 | 34:1 APP. SURFACE | 136.8 | 'C' | - |

| OBSTRUCTION TABLE | | | | RUNWAY 14 END (Ultimate) 50:1 | | |
|-------------------------|------------------|---------------------------|------------------------------|-------------------------------|----------------|-------------------------------|
| OBJECT NO./ DESCRIPTION | OBJECT ELEVATION | PART 77 SURFACE ELEVATION | PART 77 SURFACE OBJECT IS IN | OBJECT PENETRATION | | PROPOSED DISPOSITION |
| | | | | 'C'=Clears | 'OB'=Obstructs | |
| 1 Service Road | 1205.7 | 1198.9 | PRIMARY SURFACE | -6.8 | 'OB' | Restricted Interior Serv. Rd. |
| 2 North Service Road | 1198.0 | 1198.9 | 50:1 APP. SLOPE | 0.9 | 'C' | - |
| 3 Service Road | 1205.9 | 1203.5 | 50:1 APP. SLOPE | -2.4 | 'OB' | Restricted Interior Serv. Rd. |
| 4 North Service Road | 1203.0 | 1207.2 | 50:1 APP. SLOPE | 4.2 | 'C' | - |
| 5 North Service Road | 1197.5 | 1210.4 | 50:1 APP. SLOPE | 12.9 | 'C' | - |
| 6 North Service Road | 1194.1 | 1209.6 | 50:1 APP. SLOPE | 15.4 | 'C' | - |
| 7 Airport Road | 1210.2 | 1210.0 | 50:1 APP. SLOPE | -0.2 | 'OB' | Restricted Interior Serv. Rd. |
| 8 Airport Road | 1203.0 | 1213.2 | 50:1 APP. SLOPE | 10.2 | 'C' | - |
| 9 Perimeter Fence | 1205.0 | 1208.6 | 50:1 APP. SLOPE | 3.6 | 'C' | - |
| 10 Perimeter Fence | 1196.0 | 1211.7 | 50:1 APP. SLOPE | 15.7 | 'C' | - |
| 11 North Service Road | 1194.0 | 1212.7 | 50:1 APP. SLOPE | 18.7 | 'C' | - |
| 12 Perimeter Fence | 1186.0 | 1213.8 | 50:1 APP. SLOPE | 27.8 | 'C' | - |
| 13 Perimeter Fence | 1190.0 | 1214.9 | 50:1 APP. SLOPE | 24.9 | 'C' | - |
| 14 Perimeter Fence | 1184.0 | 1216.6 | 50:1 APP. SLOPE | 32.6 | 'C' | - |
| 15 Utility Pole | 1210.1 | 1222.2 | 7:1 TRANS. SURFACE | 12.1 | 'C' | - |
| 16 Building | 1205.9 | 1219.1 | 50:1 APP. SLOPE | 13.2 | 'C' | To Be Lighted |
| 17 Airport Road | 1190.1 | 1218.2 | 50:1 APP. SLOPE | 28.1 | 'C' | - |
| 18 Airport Road | 1189.4 | 1223.9 | 50:1 APP. SLOPE | 34.5 | 'C' | - |
| 19 Airport Road | 1189.2 | 1224.3 | 50:1 APP. SLOPE | 35.1 | 'C' | - |
| 20 Light Pole | 1202.8 | 1223.9 | 50:1 APP. SLOPE | 21.1 | 'C' | - |
| 21 Utility Pole | 1212.4 | 1229.1 | 50:1 APP. SLOPE | 16.7 | 'C' | - |
| 22 Private Road | 1184.5 | 1238.0 | 50:1 APP. SLOPE | 53.5 | 'C' | - |
| 23 Utility Pole | 1212.4 | 1246.2 | 7:1 TRANS. SURFACE | 33.8 | 'C' | - |
| 24 Tree Top | 1225.0 | 1241.9 | 50:1 APP. SLOPE | 16.9 | 'C' | - |
| 25 LAA Railroad | 1198.3 | 1243.1 | 50:1 APP. SLOPE | 44.8 | 'C' | - |
| 26 Utility Pole | 1210.5 | 1246.0 | 50:1 APP. SLOPE | 35.5 | 'C' | - |
| 27 Tree Top | 1205.4 | 1247.5 | 50:1 APP. SLOPE | 42.1 | 'C' | - |
| 28 LAA Railroad | 1201.0 | 1249.8 | 50:1 APP. SLOPE | 48.8 | 'C' | - |
| 29 Utility Pole | 1216.4 | 1248.7 | 50:1 APP. SLOPE | 32.3 | 'C' | - |
| 30 LAA Railroad | 1200.5 | 1250.3 | 50:1 APP. SLOPE | 49.8 | 'C' | - |
| 31 LAA Railroad | 1201.0 | 1252.2 | 50:1 APP. SLOPE | 51.2 | 'C' | - |
| 32 Tree Top | 1232.9 | 1257.9 | 50:1 APP. SLOPE | 25.0 | 'C' | - |
| 33 Tree Top | 1234.7 | 1259.3 | 50:1 APP. SLOPE | 24.6 | 'C' | - |
| 34 BN Railroad | 1203.4 | 1257.0 | 50:1 APP. SLOPE | 53.6 | 'C' | - |
| 35 BN Railroad | 1203.0 | 1262.9 | 50:1 APP. SLOPE | 59.9 | 'C' | - |
| 36 BN Railroad | 1203.2 | 1268.1 | 50:1 APP. SLOPE | 64.9 | 'C' | - |
| 37 LAA Railroad | 1202.8 | 1268.5 | 50:1 APP. SLOPE | 65.7 | 'C' | - |
| 38 BN Railroad | 1203.6 | 1274.5 | 50:1 APP. SLOPE | 70.9 | 'C' | - |
| 39 Tree Top | 1231.1 | 1277.7 | 7:1 TRANS. SURFACE | 46.6 | 'C' | - |
| 40 Tree Top | 1248.2 | 1281.7 | 50:1 APP. SLOPE | 33.5 | 'C' | - |
| 41 Tree Top | 1234.9 | 1284.3 | 50:1 APP. SLOPE | 49.4 | 'C' | - |
| 42 Tree Top | 1241.1 | 1285.1 | 50:1 APP. SLOPE | 44.0 | 'C' | - |
| 43 BN Railroad | 1204.5 | 1283.3 | 50:1 APP. SLOPE | 78.8 | 'C' | - |
| 44 Tree Top | 1237.4 | 1282.9 | 50:1 APP. SLOPE | 45.5 | 'C' | - |
| 45 Fence | 1184.0 | 1283.5 | 50:1 APP. SLOPE | 99.5 | 'C' | - |
| 46 Utility Pole | 1222.1 | 1292.9 | 50:1 APP. SLOPE | 70.8 | 'C' | - |
| 47 Tree Top | 1246.0 | 1297.8 | 50:1 APP. SLOPE | 51.8 | 'C' | - |
| 48 Tree Top | 1256.5 | 1297.9 | 50:1 APP. SLOPE | 41.4 | 'C' | - |
| 49 LAA Railroad | 1201.7 | 1267.0 | 50:1 APP. SLOPE | 65.3 | 'C' | - |
| 50 Utility Pole | 1215.3 | 1286.6 | 50:1 APP. SLOPE | 71.3 | 'C' | - |
| 51 Building | 1182.9 | 1241.9 | 50:1 APP. SLOPE | 59.0 | 'C' | To Be Lighted |
| 52 Highway 34 | 1199.3 | 1291.0 | 50:1 APP. SLOPE | 91.7 | 'C' | - |
| 53 Building | 1200.8 | 1293.2 | 50:1 APP. SLOPE | 92.4 | 'C' | - |

| 20:1 THRESHOLD SITING SURFACE OBSTRUCTION TABLE | | | RUNWAY 14 END | | |
|---|------------------|---|--------------------|----------------|----------------------|
| OBJECT NO./ DESCRIPTION | OBJECT ELEVATION | 20:1 THRESHOLD SITING SURFACE ELEVATION | OBJECT PENETRATION | | PROPOSED DISPOSITION |
| | | | 'C'=Clears | 'OB'=Obstructs | |
| 5 North Service Road | 1197.5 | 1255.9 | 58.4 | 'C' | - |
| 6 North Service Road | 1194.1 | 1253.8 | 59.7 | 'C' | - |
| 8 Airport Road | 1203.0 | 1262.8 | 59.8 | 'C' | - |
| 10 Perimeter Fence | 1196.0 | 1259.2 | 63.2 | 'C' | - |
| 11 North Service Road | 1194.0 | 1261.7 | 67.7 | 'C' | - |
| 13 Perimeter Fence | 1190.0 | 1267.3 | 77.3 | 'C' | - |
| 14 Perimeter Fence | 1184.0 | 1271.4 | 87.4 | 'C' | - |
| 17 Airport Road | 1190.1 | 1275.3 | 85.2 | 'C' | - |
| 18 Airport Road | 1189.4 | 1289.6 | 100.2 | 'C' | - |
| 24 Tree Top | 1225.0 | 1334.7 | 109.7 | 'C' | - |
| 26 Utility Pole | 1210.5 | 1344.9 | 134.4 | 'C' | - |
| 27 Tree Top | 1205.4 | 1348.5 | 143.1 | 'C' | - |
| 29 Utility Pole | 1216.4 | 1351.6 | 135.2 | 'C' | - |
| 37 LAA Railroad | 1202.8 | 1401.2 | 198.4 | 'C' | - |
| 38 BN Railroad | 1203.6 | 1416.0 | 212.4 | 'C' | - |
| 42 Tree Top | 1241.1 | 1442.7 | 201.6 | 'C' | - |
| 43 BN Railroad | 1204.5 | 1438.1 | 233.6 | 'C' | - |
| 46 Utility Pole | 1222.1 | 1462.2 | 240.1 | 'C' | - |
| 47 Tree Top | 1246.0 | 1474.5 | 228.5 | 'C' | - |
| 49 LAA Railroad | 1201.7 | 1397.3 | 195.6 | 'C' | - |
| 51 Building | 1182.9 | 1334.6 | 151.7 | 'C' | - |
| 53 Building | 1200.8 | 1462.8 | 262.0 | 'C' | - |

| NO. | REVISIONS | DATE |
|-----|-----------|------|
| - | - | - |
| - | - | - |

RUNWAY 14 OBSTRUCTION TABLES

LINCOLN AIRPORT
LINCOLN, NEBRASKA

LINCOLN OFFICE
825 J St., Box 80388
Lincoln, NE 68501
(402) 479-2200
www.hmc.com



PROJECT: ALP
DATE: August 2007
JOB NO.: 36-7049

SHEET NO.: 12/29

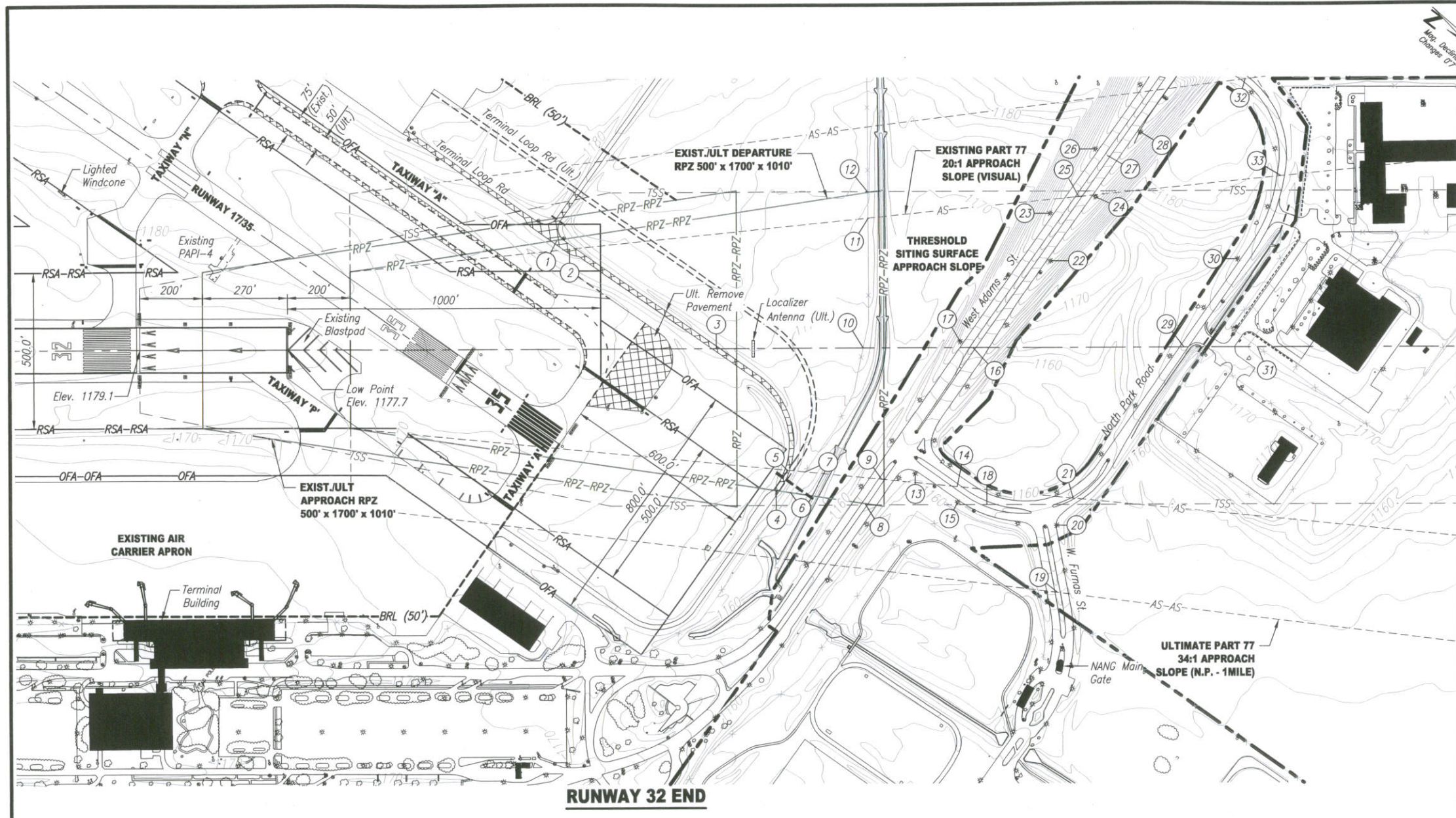

| OBSTRUCTION TABLE | | | | RUNWAY 32 END (Existing) 20:1 | |
|-------------------------|------------------|---------------------------|------------------------------|--|----------------------|
| OBJECT NO./ DESCRIPTION | OBJECT ELEVATION | PART 77 SURFACE ELEVATION | PART 77 SURFACE OBJECT IS IN | OBJECT PENETRATION "C"=Clear "OB"=Obstructs | PROPOSED DISPOSITION |
| 1 South Service Road | 1186.8 | 1216.9 | 7:1 TRANS. SURFACE | 30.1 °C | |
| 2 South Service Road | 1186.5 | 1214.2 | 20:1 APP. SURFACE | 27.7 °C | |
| 3 South Service Road | 1182.0 | 1237.4 | 20:1 APP. SURFACE | 55.4 °C | |
| 4 South Service Road | 1176.0 | 1256.5 | 7:1 TRANS. SURFACE | 80.5 °C | |
| 5 South Service Road | 1177.5 | 1248.6 | 20:1 APP. SURFACE | 71.1 °C | |
| 6 Perimeter Fence | 1172.0 | 1259.1 | 7:1 TRANS. SURFACE | 87.1 °C | |
| 7 Perimeter Fence | 1173.0 | 1251.4 | 20:1 APP. SURFACE | 78.4 °C | |
| 8 West Adams Road | 1178.1 | 1272.8 | 7:1 TRANS. SURFACE | 94.6 °C | |
| 9 West Adams Road | 1178.5 | 1263.7 | 20:1 APP. SURFACE | 85.2 °C | |
| 10 Perimeter Fence | 1179.4 | 1260.8 | 20:1 APP. SURFACE | 81.4 °C | |
| 11 Perimeter Fence | 1181.5 | 1261.6 | 20:1 APP. SURFACE | 80.1 °C | |
| 12 Perimeter Fence | 1182.0 | 1273.4 | 7:1 TRANS. SURFACE | 91.4 °C | |
| 13 Light Pole | 1204.4 | 1269.1 | 20:1 APP. SURFACE | 64.7 °C | |
| 14 North Park Road | 1178.8 | 1275.8 | 20:1 APP. SURFACE | 97.0 °C | |
| 15 Light Pole | 1194.1 | 1283.0 | 7:1 TRANS. SURFACE | 88.9 °C | |
| 16 West Adams Road | 1191.0 | 1278.4 | 20:1 APP. SURFACE | 87.4 °C | |
| 17 Light Pole | 1215.7 | 1276.4 | 20:1 APP. SURFACE | 60.7 °C | |
| 18 North Park Road | 1178.8 | 1287.3 | 7:1 TRANS. SURFACE | 108.5 °C | |
| 19 W. Furnas St. | 1184.8 | 1335.6 | 7:1 TRANS. SURFACE | 160.6 °C | |
| 20 Light Pole | 1194.8 | 1304.8 | 7:1 TRANS. SURFACE | 110.0 °C | |
| 21 North Park Road | 1180.0 | 1294.3 | 20:1 APP. SURFACE | 114.3 °C | |
| 22 Light Pole | 1226.1 | 1290.7 | 20:1 APP. SURFACE | 64.6 °C | |
| 23 Light Pole | 1234.5 | 1290.7 | 20:1 APP. SURFACE | 56.2 °C | |
| 24 Light Pole | 1237.4 | 1297.9 | 20:1 APP. SURFACE | 60.5 °C | |
| 25 West Adams Road | 1215.0 | 1295.2 | 20:1 APP. SURFACE | 80.2 °C | |
| 26 Light Pole | 1184.8 | 1318.7 | 7:1 TRANS. SURFACE | 73.3 °C | |
| 27 West Adams Road | 1221.0 | 1317.0 | 7:1 TRANS. SURFACE | 96.0 °C | |
| 28 Light Pole | 1247.2 | 1331.4 | 7:1 TRANS. SURFACE | 84.2 °C | |
| 29 North Park Road | 1187.2 | 1311.9 | 20:1 APP. SURFACE | 124.7 °C | |
| 30 Light Pole | 1207.0 | 1320.5 | 20:1 APP. SURFACE | 113.5 °C | |
| 31 Perimeter Fence | 1186.5 | 1323.7 | 20:1 APP. SURFACE | 137.2 °C | |
| 32 North Park Road | 1203.0 | 1367.6 | 7:1 TRANS. SURFACE | 164.6 °C | |
| 33 North Park Road | 1197.0 | 1327.4 | 20:1 APP. SURFACE | 130.4 °C | |

| OBSTRUCTION TABLE | | | | RUNWAY 32 END (Ultimate) 34:1 | |
|-------------------------|------------------|---------------------------|------------------------------|--|----------------------|
| OBJECT NO./ DESCRIPTION | OBJECT ELEVATION | PART 77 SURFACE ELEVATION | PART 77 SURFACE OBJECT IS IN | OBJECT PENETRATION "C"=Clear "OB"=Obstructs | PROPOSED DISPOSITION |
| 1 South Service Road | 1186.8 | 1197.1 | 34:1 APP. SURFACE | 10.3 °C | |
| 2 South Service Road | 1186.5 | 1198.3 | 34:1 APP. SURFACE | 11.8 °C | |
| 3 South Service Road | 1182.0 | 1212.0 | 34:1 APP. SURFACE | 30.0 °C | |
| 4 South Service Road | 1176.0 | 1217.6 | 34:1 APP. SURFACE | 41.6 °C | |
| 5 South Service Road | 1177.5 | 1218.6 | 34:1 APP. SURFACE | 41.1 °C | |
| 6 Perimeter Fence | 1172.0 | 1218.9 | 34:1 APP. SURFACE | 46.9 °C | |
| 7 Perimeter Fence | 1173.0 | 1220.3 | 34:1 APP. SURFACE | 47.3 °C | |
| 8 West Adams Road | 1178.1 | 1225.9 | 34:1 APP. SURFACE | 47.8 °C | |
| 9 West Adams Road | 1178.5 | 1227.5 | 34:1 APP. SURFACE | 49.0 °C | |
| 10 Perimeter Fence | 1179.4 | 1225.8 | 34:1 APP. SURFACE | 46.3 °C | |
| 11 Perimeter Fence | 1181.5 | 1226.2 | 34:1 APP. SURFACE | 44.7 °C | |
| 12 Perimeter Fence | 1182.0 | 1226.2 | 34:1 APP. SURFACE | 44.2 °C | |
| 13 Light Pole | 1204.4 | 1230.7 | 34:1 APP. SURFACE | 26.3 °C | |
| 14 North Park Road | 1178.8 | 1234.6 | 34:1 APP. SURFACE | 55.8 °C | |
| 15 Light Pole | 1194.1 | 1234.7 | 34:1 APP. SURFACE | 40.6 °C | |
| 16 West Adams Road | 1191.0 | 1236.1 | 34:1 APP. SURFACE | 45.1 °C | |
| 17 Light Pole | 1215.7 | 1234.9 | 34:1 APP. SURFACE | 19.2 °C | |
| 18 North Park Road | 1178.8 | 1237.4 | 34:1 APP. SURFACE | 58.6 °C | |
| 19 W. Furnas St. | 1175.0 | 1244.0 | 34:1 APP. SURFACE | 69.0 °C | |
| 20 Light Pole | 1184.8 | 1243.9 | 34:1 APP. SURFACE | 49.1 °C | |
| 21 North Park Road | 1180.0 | 1245.5 | 34:1 APP. SURFACE | 65.5 °C | |
| 22 Light Pole | 1226.1 | 1243.4 | 34:1 APP. SURFACE | 17.3 °C | |
| 23 Light Pole | 1234.5 | 1243.3 | 34:1 APP. SURFACE | 8.9 °C | |
| 24 Light Pole | 1237.4 | 1247.6 | 34:1 APP. SURFACE | 10.2 °C | |
| 25 West Adams Road | 1215.0 | 1246.0 | 34:1 APP. SURFACE | 31.0 °C | |
| 26 Light Pole | 1245.4 | 1247.5 | 34:1 APP. SURFACE | 2.2 °C | |
| 27 West Adams Road | 1221.0 | 1248.7 | 34:1 APP. SURFACE | 27.7 °C | |
| 28 Light Pole | 1247.2 | 1251.8 | 34:1 APP. SURFACE | 4.5 °C | |
| 29 North Park Road | 1187.2 | 1255.8 | 34:1 APP. SURFACE | 68.6 °C | |
| 30 Light Pole | 1207.0 | 1260.9 | 34:1 APP. SURFACE | 53.8 °C | |
| 31 Perimeter Fence | 1186.5 | 1262.8 | 34:1 APP. SURFACE | 76.2 °C | |
| 32 North Park Road | 1203.0 | 1261.6 | 34:1 APP. SURFACE | 58.6 °C | |
| 33 North Park Road | 1197.0 | 1264.9 | 34:1 APP. SURFACE | 67.9 °C | |

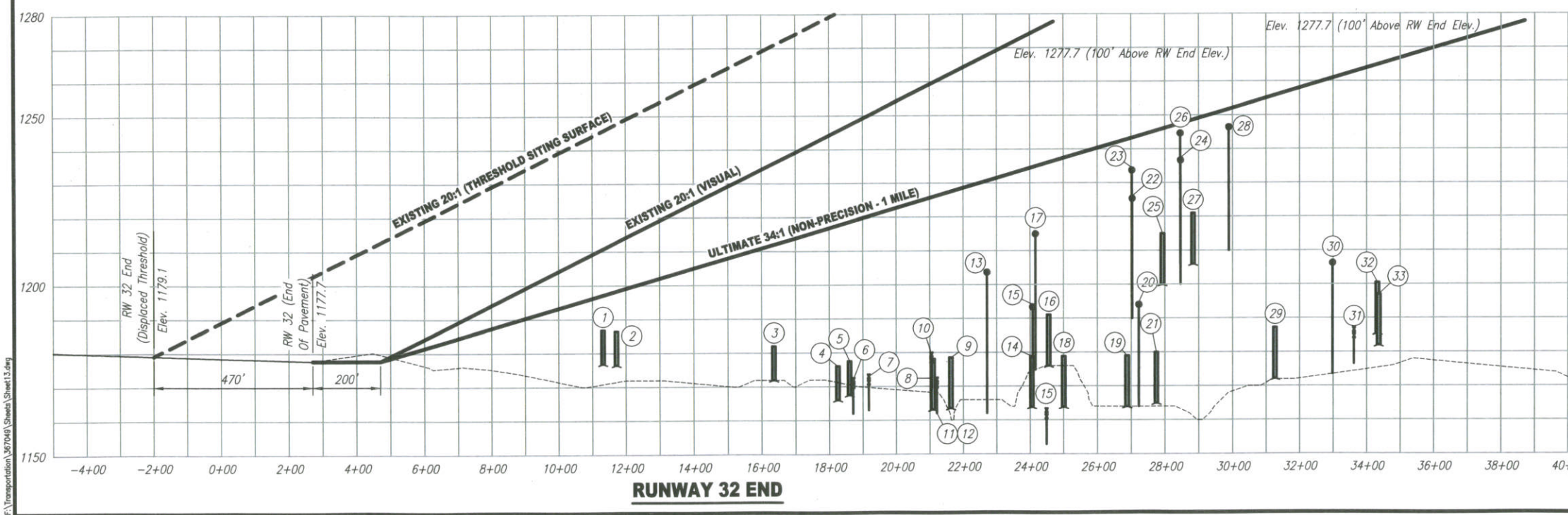

| 20:1 THRESHOLD SITING SURFACE OBSTRUCTION TABLE | | | | RUNWAY 32 END | |
|---|------------------|---|--|----------------------|--|
| OBJECT NO./ DESCRIPTION | OBJECT ELEVATION | 20:1 THRESHOLD SITING SURFACE ELEVATION | OBJECT PENETRATION "C"=Clear "OB"=Obstructs | PROPOSED DISPOSITION | |
| 1 South Service Road | 1186.8 | 1245.6 | 58.8 °C | | |
| 2 South Service Road | 1186.5 | 1247.7 | 61.2 °C | | |
| 3 South Service Road | 1182.0 | 1270.9 | 88.9 °C | | |
| 4 South Service Road | 1176.0 | 1280.4 | 104.4 °C | | |
| 5 South Service Road | 1177.5 | 1282.1 | 104.6 °C | | |
| 6 Perimeter Fence | 1172.0 | 1282.6 | 110.6 °C | | |
| 7 Perimeter Fence | 1173.0 | 1285.0 | 112.0 °C | | |
| 8 West Adams Road | 1178.1 | 1294.6 | 116.4 °C | | |
| 9 West Adams Road | 1178.5 | 1297.2 | 118.7 °C | | |
| 10 Perimeter Fence | 1179.4 | 1294.3 | 114.9 °C | | |
| 11 Perimeter Fence | 1181.5 | 1295.1 | 113.6 °C | | |
| 12 Perimeter Fence | 1182.0 | 1295.1 | 113.1 °C | | |
| 13 Light Pole | 1204.4 | 1302.6 | 98.2 °C | | |
| 14 North Park Road | 1178.8 | 1309.3 | 130.5 °C | | |
| 15 Light Pole | 1194.1 | 1309.4 | 115.3 °C | | |
| 16 West Adams Road | 1191.0 | 1311.9 | 120.9 °C | | |
| 17 Light Pole | 1215.7 | 1309.9 | 94.2 °C | | |
| 21 North Park Road | 1180.0 | 1327.8 | 147.8 °C | | |
| 22 Light Pole | 1226.1 | 1324.2 | 98.1 °C | | |
| 23 Light Pole | 1234.5 | 1324.2 | 80.7 °C | | |
| 24 Light Pole | 1237.4 | 1331.4 | 94.0 °C | | |
| 25 West Adams Road | 1215.0 | 1328.7 | 113.7 °C | | |
| 29 North Park Road | 1187.2 | 1345.4 | 158.2 °C | | |
| 30 Light Pole | 1207.0 | 1354.0 | 147.0 °C | | |
| 31 Perimeter Fence | 1186.5 | 1357.2 | 170.7 °C | | |

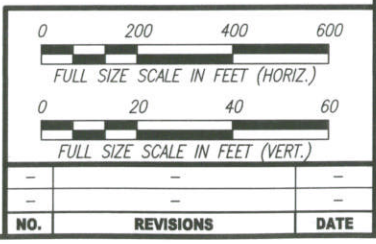

F:\Transportation\367049\Sheet\Sheet13.dwg

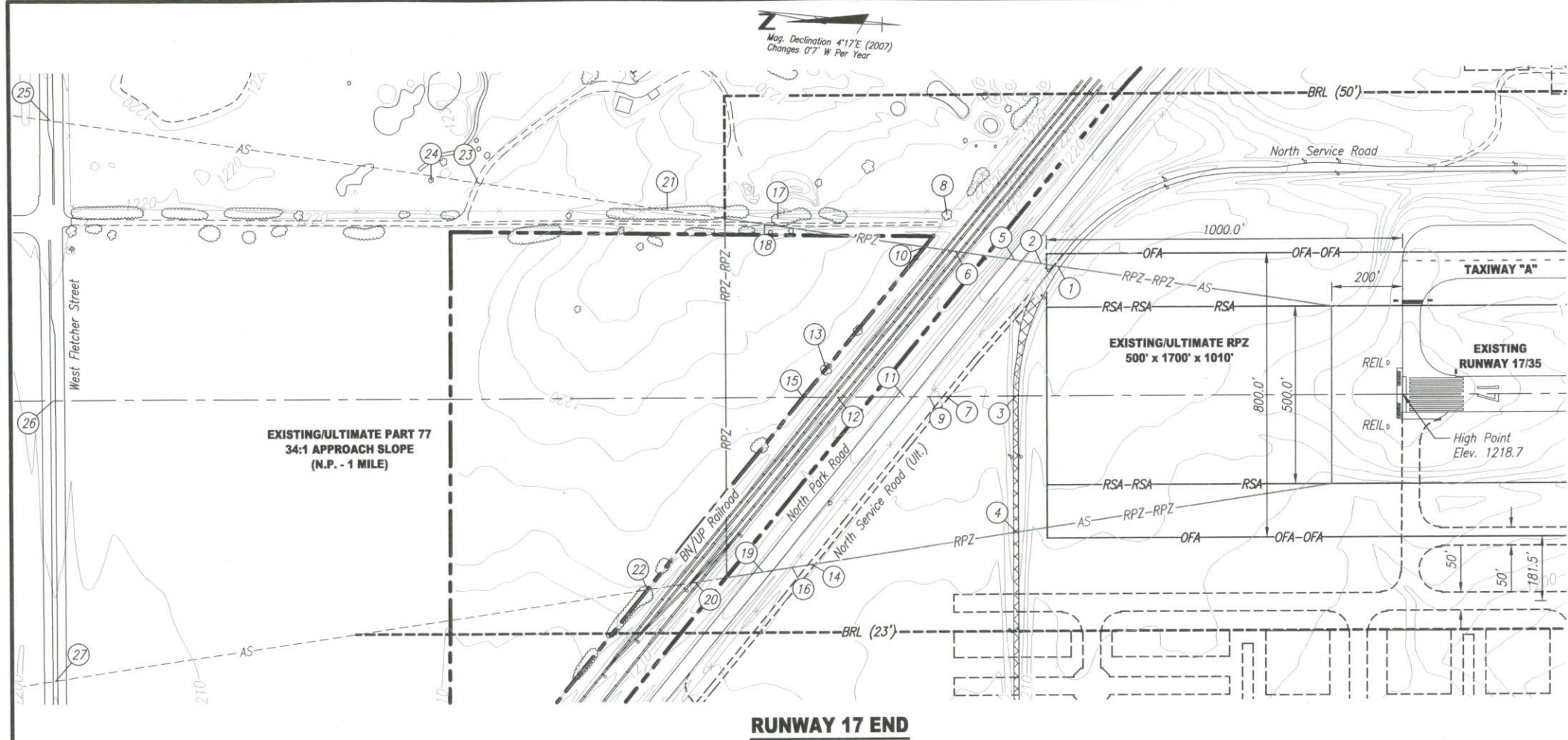

| OBJECT NO./ DESCRIPTION | OBJECT ELEVATION | PART 77 SURFACE ELEVATION | PART 77 SURFACE OBJECT IS IN | OBJECT PENETRATION | | PROPOSED DISPOSITION |
|---------------------------|------------------|---------------------------|------------------------------|--------------------|---------------|----------------------|
| | | | | 'C'=Clear | 'O'=Obstructs | |
| 1 North Service Road | 1230.0 | 1241.2 | 34:1 APP. SURFACE | 11.2 | 'C' | |
| 2 Perimeter Fence | 1227.1 | 1242.6 | 34:1 APP. SURFACE | 15.4 | 'C' | |
| 3 North Service Road | 1228.0 | 1244.7 | 34:1 APP. SURFACE | 16.7 | 'C' | |
| 4 North Service Road | 1226.0 | 1244.7 | 34:1 APP. SURFACE | 18.7 | 'C' | |
| 5 North Park Road | 1232.0 | 1244.8 | 34:1 APP. SURFACE | 12.8 | 'C' | |
| 6 BN/UP Railroad | 1242.5 | 1249.6 | 34:1 APP. SURFACE | 7.1 | 'C' | |
| 7 North Service Rd. (UL) | 1224.0 | 1250.4 | 34:1 APP. SURFACE | 26.4 | 'C' | |
| 8 Tree Top | 1244.0 | 1244.6 | 7:1 TRANS. SURFACE | 20.6 | 'C' | |
| 9 Perimeter Fence | 1224.0 | 1251.8 | 34:1 APP. SURFACE | 27.8 | 'C' | |
| 10 Fence | 1223.3 | 1252.2 | 34:1 APP. SURFACE | 28.9 | 'C' | |
| 11 North Park Road | 1230.5 | 1253.9 | 34:1 APP. SURFACE | 23.4 | 'C' | |
| 12 BN/UP Rail Road | 1239.0 | 1259.4 | 34:1 APP. SURFACE | 20.4 | 'C' | |
| 13 Tree Top | 1242.5 | 1260.3 | 34:1 APP. SURFACE | 17.8 | 'C' | |
| 14 North Service Rd. (UL) | 1222.3 | 1261.6 | 34:1 APP. SURFACE | 39.3 | 'C' | |
| 15 Fence | 1219.2 | 1262.2 | 34:1 APP. SURFACE | 43.0 | 'C' | |
| 16 Perimeter Fence | 1222.5 | 1263.2 | 34:1 APP. SURFACE | 40.7 | 'C' | |
| 17 Tree Top | 1259.3 | 1267.3 | 7:1 TRANS. SURFACE | 8.0 | 'C' | |
| 18 Private Road | 1234.3 | 1265.4 | 34:1 APP. SURFACE | 31.0 | 'C' | |
| 19 North Park Road | 1227.8 | 1265.6 | 34:1 APP. SURFACE | 37.8 | 'C' | |
| 20 BN/UP Railroad | 1237.0 | 1271.2 | 34:1 APP. SURFACE | 34.2 | 'C' | |
| 21 Fence | 1230.0 | 1273.3 | 34:1 APP. SURFACE | 43.3 | 'C' | |
| 22 Fence | 1218.0 | 1275.1 | 34:1 APP. SURFACE | 57.1 | 'C' | |
| 23 Private Road | 1232.2 | 1289.0 | 34:1 APP. SURFACE | 56.8 | 'C' | |
| 24 Tree Top | 1241.2 | 1292.9 | 34:1 APP. SURFACE | 51.7 | 'C' | |
| 25 W. Fletcher Street | 1244.1 | 1324.2 | 34:1 APP. SURFACE | 80.1 | 'C' | |
| 26 W. Fletcher Street | 1230.0 | 1324.2 | 34:1 APP. SURFACE | 94.2 | 'C' | |
| 27 W. Fletcher Street | 1225.0 | 1324.1 | 34:1 APP. SURFACE | 99.1 | 'C' | |

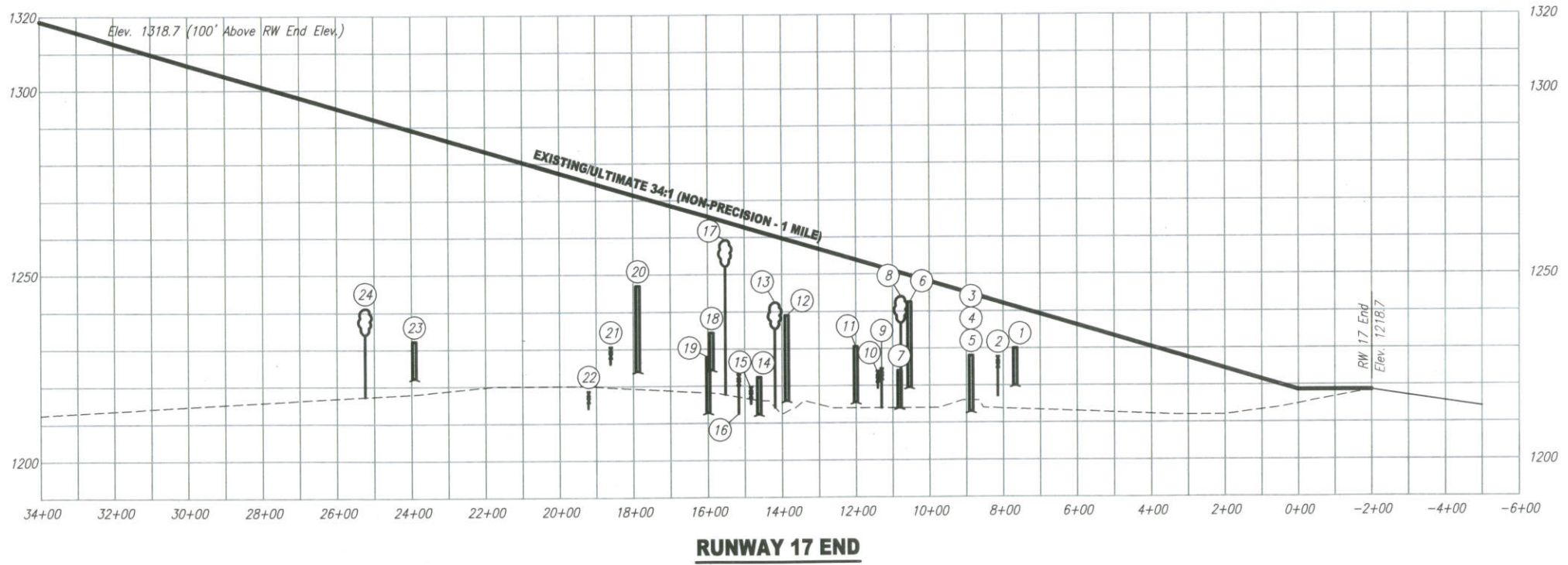

0 200 400 600
FULL SIZE SCALE IN FEET (HORIZ.)

0 20 40 60
FULL SIZE SCALE IN FEET (VERT.)

| NO. | REVISIONS | DATE |
|-----|-----------|------|
| - | - | - |
| - | - | - |

INNER PORTION OF EXIST./ULT. RUNWAY 17 APPROACH SURFACE DRAWING

LINCOLN AIRPORT
LINCOLN, NEBRASKA

LINCOLN OFFICE
825 J St., Box 80388
Lincoln, NE 68501
(402) 479-2200
www.hws.com



PROJECT: ALP
DATE: August 2007
JOB NO.: 36-7049
SHEET NO.: 14/29

F:\Transportation\367049\Sheet4.dwg

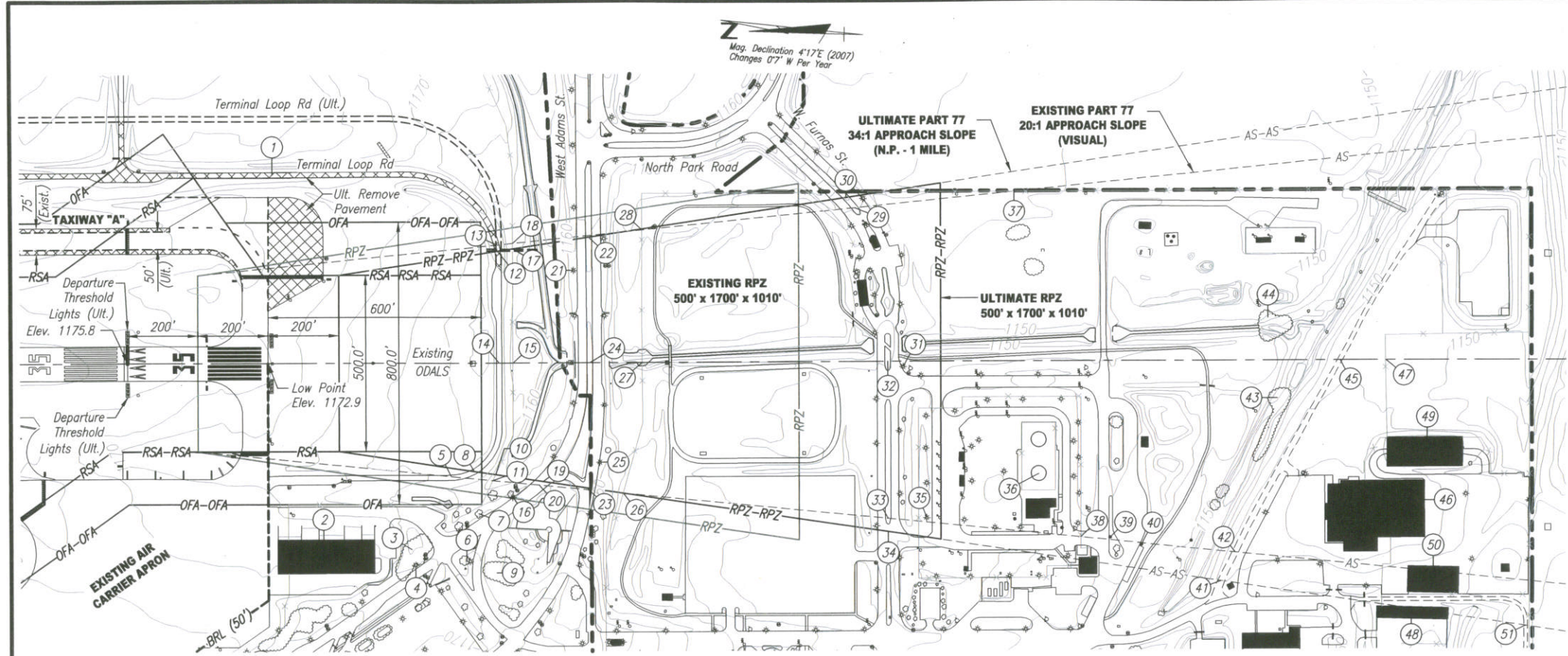

RUNWAY 35 END

| OBJECT NO/ DESCRIPTION | OBJECT ELEVATION | PART 77 SURFACE ELEVATION | PART 77 SURFACE OBJECT IS IN | RUNWAY 35 END (Existing) 20:1 | | PROPOSED DISPOSITION |
|---------------------------|---------------------|------------------------------|---------------------------------|---|-----|-------------------------|
| | | | | OBJECT PENETRATION 'C'=Clears 'OB'=Obstructs | | |
| 1 Terminal Loop Road | 1185.3 | 1224.1 | 7:1 TRANS. SURFACE | 38.8 | 'C' | |
| 2 Building | 1191.9 | 1230.5 | 7:1 TRANS. SURFACE | 38.6 | 'C' | |
| 3 Light Pole | 1197.2 | 1244.0 | 7:1 TRANS. SURFACE | 46.8 | 'C' | |
| 4 Tree Top | 1202.8 | 1237.1 | 7:1 TRANS. SURFACE | 34.3 | 'C' | |
| 5 Terminal Loop Road | 1175.9 | 1211.5 | 20:1 APP. SURFACE | 35.6 | 'C' | |
| 6 Tree Top | 1200.3 | 1247.1 | 7:1 TRANS. SURFACE | 46.8 | 'C' | |
| 7 Tree Top | 1201.2 | 1229.3 | 7:1 TRANS. SURFACE | 28.1 | 'C' | |
| 8 Terminal Loop Road | 1175.7 | 1214.7 | 20:1 APP. SURFACE | 39.0 | 'C' | |
| 9 Tree Top | 1202.6 | 1255.0 | 7:1 TRANS. SURFACE | 52.4 | 'C' | |
| 10 Perimeter Fence | 1172.0 | 1217.8 | 20:1 APP. SURFACE | 45.8 | 'C' | |
| 11 Perimeter Fence | 1172.0 | 1217.4 | 20:1 APP. SURFACE | 45.4 | 'C' | |
| 12 Terminal Loop Road | 1176.5 | 1218.1 | 20:1 APP. SURFACE | 41.6 | 'C' | |
| 13 Terminal Loop Road | 1177.0 | 1218.0 | 20:1 APP. SURFACE | 41.0 | 'C' | |
| 14 Terminal Loop Road | 1174.3 | 1218.3 | 20:1 APP. SURFACE | 44.0 | 'C' | |
| 15 Perimeter Fence | 1172.0 | 1220.3 | 20:1 APP. SURFACE | 48.3 | 'C' | |
| 16 Light Pole | 1192.9 | 1226.1 | 7:1 TRANS. SURFACE | 33.3 | 'C' | |
| 17 Perimeter Fence | 1172.0 | 1220.3 | 20:1 APP. SURFACE | 48.3 | 'C' | |
| 18 Perimeter Fence | 1172.5 | 1220.3 | 20:1 APP. SURFACE | 47.8 | 'C' | |
| 19 West Adams St | 1178.7 | 1224.5 | 20:1 APP. SURFACE | 45.8 | 'C' | |
| 20 West Adams St | 1178.7 | 1223.9 | 20:1 APP. SURFACE | 45.2 | 'C' | |
| 21 Light Pole | 1191.4 | 1228.9 | 20:1 APP. SURFACE | 37.5 | 'C' | |
| 22 West Adams St | 1177.0 | 1231.1 | 20:1 APP. SURFACE | 54.1 | 'C' | |
| 23 West Adams St | 1176.7 | 1230.9 | 20:1 APP. SURFACE | 54.1 | 'C' | |
| 24 West Adams St | 1177.2 | 1231.2 | 20:1 APP. SURFACE | 54.0 | 'C' | |
| 25 Light Pole | 1191.0 | 1232.6 | 20:1 APP. SURFACE | 41.5 | 'C' | |
| 26 Perimeter Fence | 1166.0 | 1235.9 | 20:1 APP. SURFACE | 69.9 | 'C' | |
| 27 Perimeter Fence | 1162.0 | 1238.6 | 20:1 APP. SURFACE | 76.6 | 'C' | |
| 28 Perimeter Fence | 1165.8 | 1238.6 | 20:1 APP. SURFACE | 72.8 | 'C' | |
| 29 W. Fumas Road | 1168.9 | 1268.7 | 20:1 APP. SURFACE | 99.8 | 'C' | |
| 30 W. Fumas Road | 1170.9 | 1272.0 | 7:1 TRANS. SURFACE | 101.1 | 'C' | |
| 31 Light Pole | 1183.0 | 1275.4 | 20:1 APP. SURFACE | 92.4 | 'C' | |
| 32 W. Fumas Road | 1168.8 | 1273.3 | 20:1 APP. SURFACE | 104.5 | 'C' | |
| 33 W. Fumas Road | 1167.7 | 1273.3 | 20:1 APP. SURFACE | 105.6 | 'C' | |
| 34 W. Fumas Road | 1167.4 | 1278.7 | 7:1 TRANS. SURFACE | 111.3 | 'C' | |
| 35 Light Pole | 1184.9 | 1278.8 | 20:1 APP. SURFACE | 93.9 | 'C' | |
| 36 Tank | 1191.9 | 1294.7 | 20:1 APP. SURFACE | 102.7 | 'C' | |
| 37 Perimeter Fence | 1163.1 | 1291.2 | 20:1 APP. SURFACE | 128.0 | 'C' | |
| 38 Perimeter Fence | 1161.3 | 1300.6 | 20:1 APP. SURFACE | 139.3 | 'C' | |
| 39 Utility Pole | 1180.0 | 1304.8 | 20:1 APP. SURFACE | 124.7 | 'C' | |
| 40 Utility Pole | 1181.7 | 1309.7 | 7:1 TRANS. SURFACE | 128.0 | 'C' | |
| 41 Private Road | 1161.9 | 1322.9 | 7:1 TRANS. SURFACE | 170.7 | 'C' | |
| 42 Private Road | 1163.0 | 1322.4 | 20:1 APP. SURFACE | 159.4 | 'C' | |
| 43 Tree Top | 1171.2 | 1328.4 | 20:1 APP. SURFACE | 157.2 | 'C' | |
| 44 Tree Top | 1174.3 | 1327.0 | 20:1 APP. SURFACE | 152.8 | 'C' | |
| 45 Private Road | 1161.3 | 1337.3 | 20:1 APP. SURFACE | 176.0 | 'C' | |
| 46 Building | 1185.4 | 1344.7 | 20:1 APP. SURFACE | 159.3 | 'C' | |
| 47 Perimeter Fence | 1159.3 | 1343.8 | 20:1 APP. SURFACE | 184.5 | 'C' | |
| 48 Building | 1171.9 | 1365.1 | 7:1 TRANS. SURFACE | 193.2 | 'C' | |
| 49 Building | 1173.5 | 1349.7 | 20:1 APP. SURFACE | 176.2 | 'C' | |
| 50 Building | 1168.9 | 1353.9 | 7:1 TRANS. SURFACE | 185.0 | 'C' | |
| 51 Private Road | 1163.1 | 1381.9 | 7:1 TRANS. SURFACE | 218.8 | 'C' | |

| OBJECT NO/ DESCRIPTION | OBJECT ELEVATION | PART 77 SURFACE ELEVATION | PART 77 SURFACE OBJECT IS IN | RUNWAY 35 END (Ultimate) 34:1 | | PROPOSED DISPOSITION |
|---------------------------|---------------------|------------------------------|---------------------------------|---|------|-------------------------|
| | | | | OBJECT PENETRATION 'C'=Clears 'OB'=Obstructs | | |
| 1 Terminal Loop Road | 1185.3 | 1172.9 | PRIMARY SURFACE | -12.4 | 'OB' | Relocate Ultimate |
| 2 Building | 1191.9 | 1214.6 | 7:1 TRANS. SURFACE | 22.7 | 'C' | |
| 3 Light Pole | 1197.2 | 1220.9 | 7:1 TRANS. SURFACE | 23.7 | 'C' | |
| 4 Tree Top | 1202.8 | 1214.2 | 7:1 TRANS. SURFACE | 11.4 | 'C' | |
| 5 Terminal Loop Road | 1175.9 | 1185.6 | 7:1 TRANS. SURFACE | 9.7 | 'C' | |
| 6 Tree Top | 1200.3 | 1220.1 | 7:1 TRANS. SURFACE | 19.7 | 'C' | |
| 7 Tree Top | 1201.2 | 1201.3 | 7:1 TRANS. SURFACE | 0.1 | 'C' | |
| 8 Terminal Loop Road | 1175.7 | 1184.1 | 34:1 APP. SURFACE | 8.4 | 'C' | |
| 9 Tree Top | 1202.6 | 1225.6 | 7:1 TRANS. SURFACE | 23.0 | 'C' | |
| 10 Perimeter Fence | 1172.0 | 1185.8 | 34:1 APP. SURFACE | 13.8 | 'C' | |
| 11 Perimeter Fence | 1172.0 | 1188.2 | 7:1 TRANS. SURFACE | 16.2 | 'C' | |
| 12 Terminal Loop Road | 1176.5 | 1186.1 | 34:1 APP. SURFACE | 9.6 | 'C' | |
| 13 Terminal Loop Road | 1177.0 | 1188.5 | 7:1 TRANS. SURFACE | 11.5 | 'C' | |
| 14 Terminal Loop Road | 1174.3 | 1186.2 | 34:1 APP. SURFACE | 11.9 | 'C' | |
| 15 Perimeter Fence | 1172.0 | 1187.3 | 34:1 APP. SURFACE | 15.3 | 'C' | |
| 16 Light Pole | 1192.9 | 1195.4 | 7:1 TRANS. SURFACE | 2.6 | 'C' | |
| 17 Perimeter Fence | 1172.0 | 1187.3 | 34:1 APP. SURFACE | 15.3 | 'C' | |
| 18 Perimeter Fence | 1172.5 | 1189.5 | 7:1 TRANS. SURFACE | 17.0 | 'C' | |
| 19 West Adams St | 1178.7 | 1189.8 | 34:1 APP. SURFACE | 11.1 | 'C' | |
| 20 West Adams St | 1178.7 | 1191.1 | 7:1 TRANS. SURFACE | 12.4 | 'C' | |
| 21 Light Pole | 1191.4 | 1192.4 | 34:1 APP. SURFACE | 1.0 | 'C' | |
| 22 West Adams St | 1177.0 | 1193.7 | 34:1 APP. SURFACE | 16.7 | 'C' | |
| 23 West Adams St | 1176.7 | 1193.9 | 7:1 TRANS. SURFACE | 17.2 | 'C' | |
| 24 West Adams St | 1177.2 | 1193.7 | 34:1 APP. SURFACE | 16.5 | 'C' | |
| 25 Light Pole | 1191.0 | 1194.6 | 34:1 APP. SURFACE | 3.5 | 'C' | |
| 26 Perimeter Fence | 1166.0 | 1196.5 | 34:1 APP. SURFACE | 30.5 | 'C' | |
| 27 Perimeter Fence | 1162.0 | 1198.1 | 34:1 APP. SURFACE | 36.1 | 'C' | |
| 28 Perimeter Fence | 1165.8 | 1198.1 | 34:1 APP. SURFACE | 32.3 | 'C' | |
| 29 W. Fumas Road | 1168.9 | 1215.8 | 34:1 APP. SURFACE | 46.9 | 'C' | |
| 30 W. Fumas Road | 1170.9 | 1215.1 | 34:1 APP. SURFACE | 44.2 | 'C' | |
| 31 Light Pole | 1183.0 | 1219.8 | 34:1 APP. SURFACE | 36.7 | 'C' | |
| 32 W. Fumas Road | 1168.8 | 1218.5 | 34:1 APP. SURFACE | 49.7 | 'C' | |
| 33 W. Fumas Road | 1167.7 | 1218.5 | 34:1 APP. SURFACE | 50.8 | 'C' | |
| 34 W. Fumas Road | 1167.4 | 1218.5 | 34:1 APP. SURFACE | 51.1 | 'C' | |
| 35 Light Pole | 1184.9 | 1221.7 | 34:1 APP. SURFACE | 36.9 | 'C' | |
| 36 Tank | 1191.9 | 1231.1 | 34:1 APP. SURFACE | 39.1 | 'C' | |
| 37 Perimeter Fence | 1163.1 | 1229.0 | 34:1 APP. SURFACE | 65.9 | 'C' | |
| 38 Perimeter Fence | 1161.3 | 1234.6 | 34:1 APP. SURFACE | 73.3 | 'C' | |
| 39 Utility Pole | 1180.0 | 1237.0 | 34:1 APP. SURFACE | 57.0 | 'C' | |
| 40 Utility Pole | 1181.7 | 1236.6 | 34:1 APP. SURFACE | 57.9 | 'C' | |
| 41 Private Road | 1161.9 | 1246.3 | 34:1 APP. SURFACE | 84.4 | 'C' | |
| 42 Private Road | 1163.0 | 1247.4 | 34:1 APP. SURFACE | 84.4 | 'C' | |
| 43 Tree Top | 1171.2 | 1250.9 | 34:1 APP. SURFACE | 79.8 | 'C' | |
| 44 Tree Top | 1174.3 | 1250.1 | 34:1 APP. SURFACE | 75.8 | 'C' | |
| 45 Private Road | 1161.3 | 1256.2 | 34:1 APP. SURFACE | 94.9 | 'C' | |
| 46 Building | 1185.4 | 1260.5 | 34:1 APP. SURFACE | 75.1 | 'C' | |
| 47 Perimeter Fence | 1159.3 | 1260.0 | 34:1 APP. SURFACE | 100.7 | 'C' | |
| 48 Building | 1171.9 | 1263.8 | 7:1 TRANS. SURFACE | 91.9 | 'C' | |
| 49 Building | 1173.5 | 1263.4 | 34:1 APP. SURFACE | 89.9 | 'C' | |
| 50 Building | 1168.9 | 1263.9 | 34:1 APP. SURFACE | 95.0 | 'C' | |
| 51 Private Road | 1163.1 | 1271.6 | 34:1 APP. SURFACE | 108.5 | 'C' | |

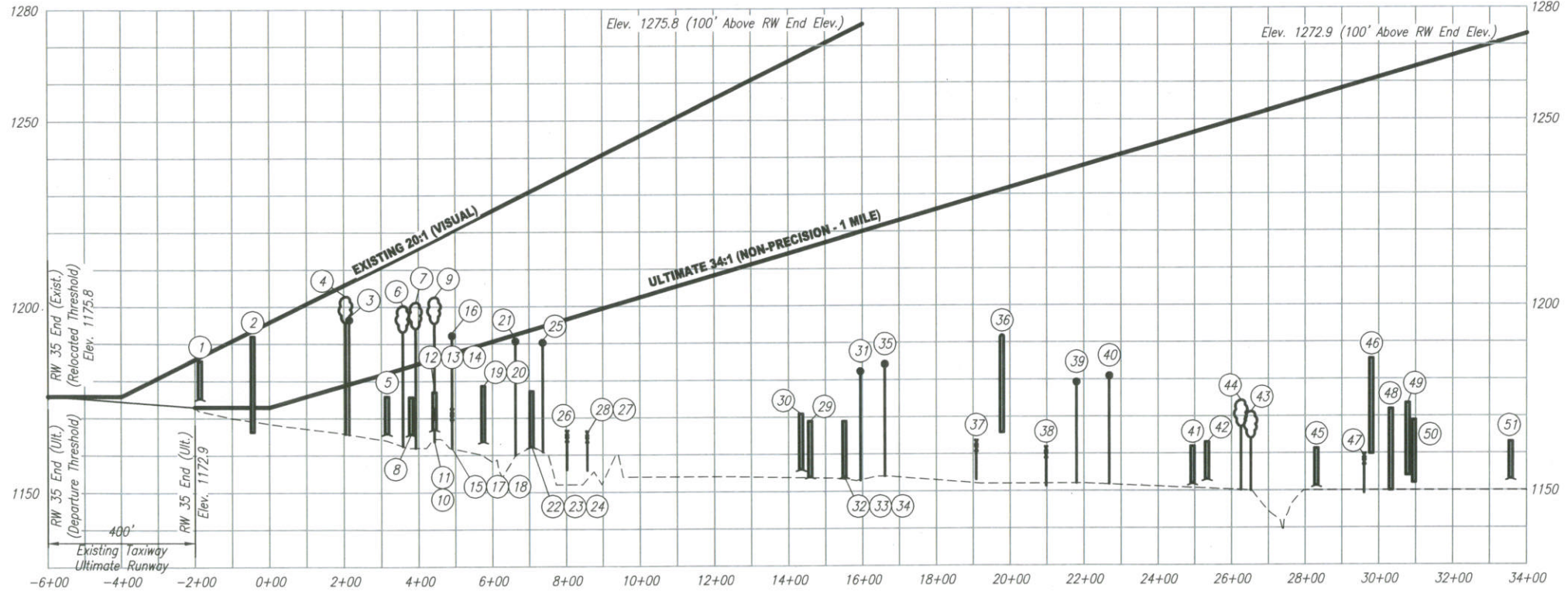

RUNWAY 35 END

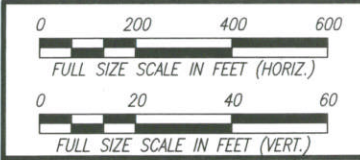

| NO. | REVISIONS | DATE |
|-----|-----------|------|
| | | |

INNER PORTION OF EXIST./ULT. RUNWAY 35
APPROACH SURFACE DRAWING

LINCOLN AIRPORT
LINCOLN, NEBRASKA

LINCOLN OFFICE
625 J St., Box 80388
Lincoln, NE 68501
(402) 479-2200
www.hms.com



PROJECT
ALP
DATE
August 2007
JOB NO.
36-7049
SHEET NO.
15
29

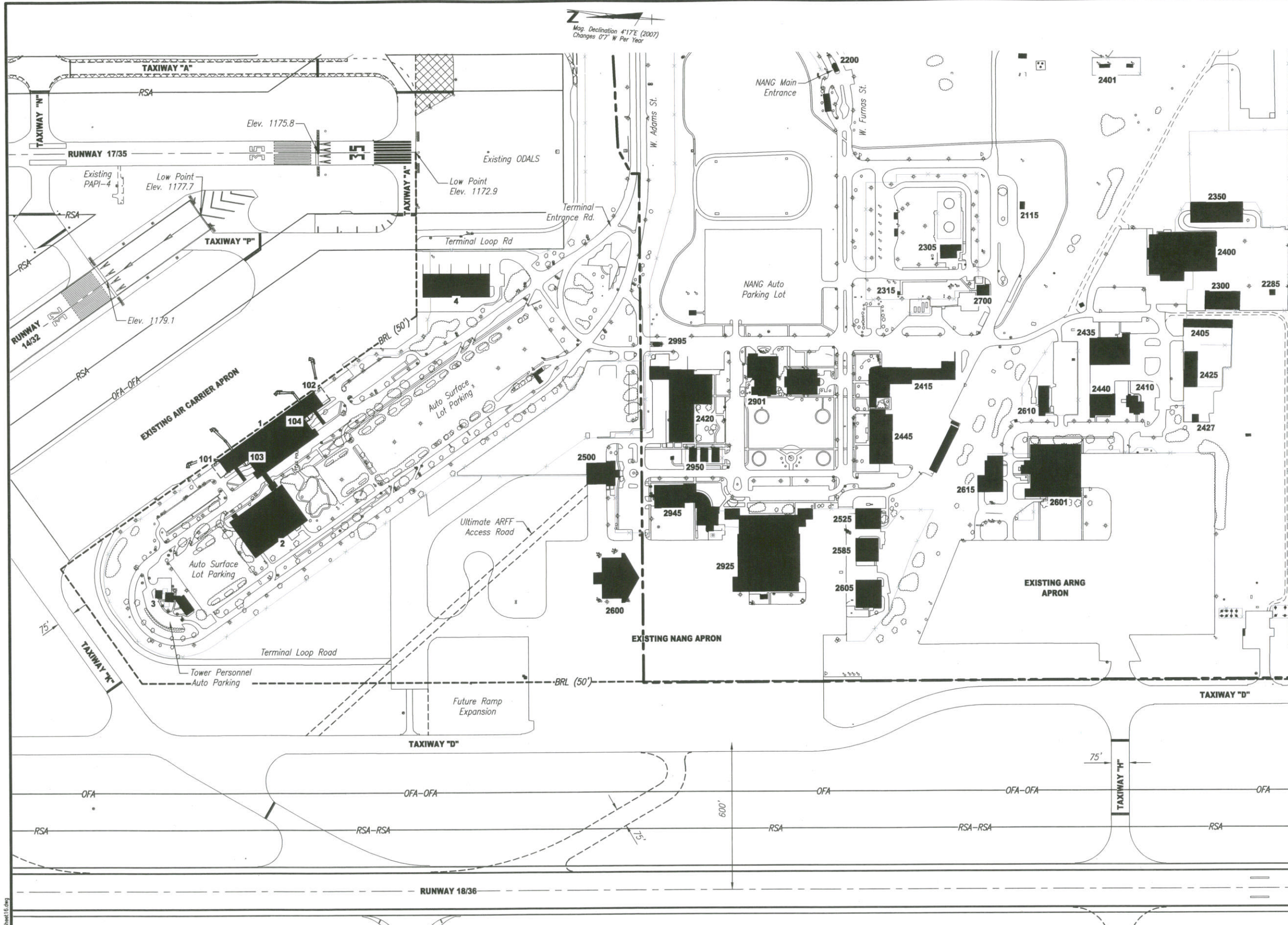

| TERMINAL AREA BUILDINGS/FACILITIES | | |
|------------------------------------|----------------------------------|--------------------|
| Number | Description | Facility Top Elev. |
| 1 | Administration/Terminal Building | 1221.5 |
| 2 | Terminal Parking Structure | 1216.4 |
| 3 | Air Traffic Control Tower (ATCT) | 1266.3 |
| 4 | Air Freight Building | 1191.9 |
| 101 | Administration/Terminal Building | - |
| 102 | Administration/Terminal Building | - |
| 103 | TSA Equipment | - |
| 104 | TSA Equipment | - |

| NEB AIR NTN'L. GRD. BUILDINGS/FACILITIES | | |
|--|---------------------|--------------------|
| Number | Description | Facility Top Elev. |
| 2115 | - | 1162.9 |
| 2200 | - | 1165.7 |
| 2285 | Flammable Storage | 1170.9 |
| 2300 | Storage | 1168.9 |
| 2305 | Pump House | 1172.6 |
| 2315 | - | 1164.9 |
| 2350 | - | 1173.5 |
| 2400 | ARNG Armory | 1185.4 |
| 2405 | Mob. Storage | 1171.9 |
| 2410 | BX | 1173.5 |
| 2415 | - | 1189.4 |
| 2420 | Supply/Comm. | 1187.9 |
| 2425 | CE Storage | 1173.1 |
| 2427 | Storage | 1162.8 |
| 2435 | Security | 1168.7 |
| 2440 | Clinic | 1169.6 |
| 2445 | Civil Engineering | 1179.7 |
| 2500 | Fire Station | 1200.7 |
| 2525 | Engine Shop | 1193.4 |
| 2585 | - | 1182.9 |
| 2600 | Fuels Hangar | 1239.3 |
| 2601 | ARNG Hangar | 1205.7 |
| 2605 | A. G. E. | 1190.5 |
| 2610 | Transportation | 1176.3 |
| 2615 | - | 1177.4 |
| 2700 | - | 1164.9 |
| 2901 | Dining Hall | 1182.7 |
| 2925 | Main Hangar | 1220.5 |
| 2945 | Squadron Operations | 1188 |
| 2950 | - | 1177.7 |
| 2995 | Main Gate | 1175.3 |

TERMINAL AREA DRAWING

LINCOLN AIRPORT
LINCOLN, NEBRASKA

TERMINAL AREA DRAWING

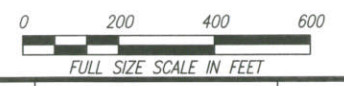

| NO. | REVISIONS | DATE |
|-----|-----------|------|
| | | |
| | | |
| | | |

LINCOLN OFFICE
825 S. St. Bldg. 80306
Lincoln, NE 68501
(402) 479-2200
www.hmc.com



PROJECT
ALP
DATE
August 2007
JOB NO.
36-7049
SHEET NO.
16
29

E:\Transportation\367049\Sheet\Sheet16.dwg

Mag. Declination 4°17'E (2007)
Changes 07" W Per Year

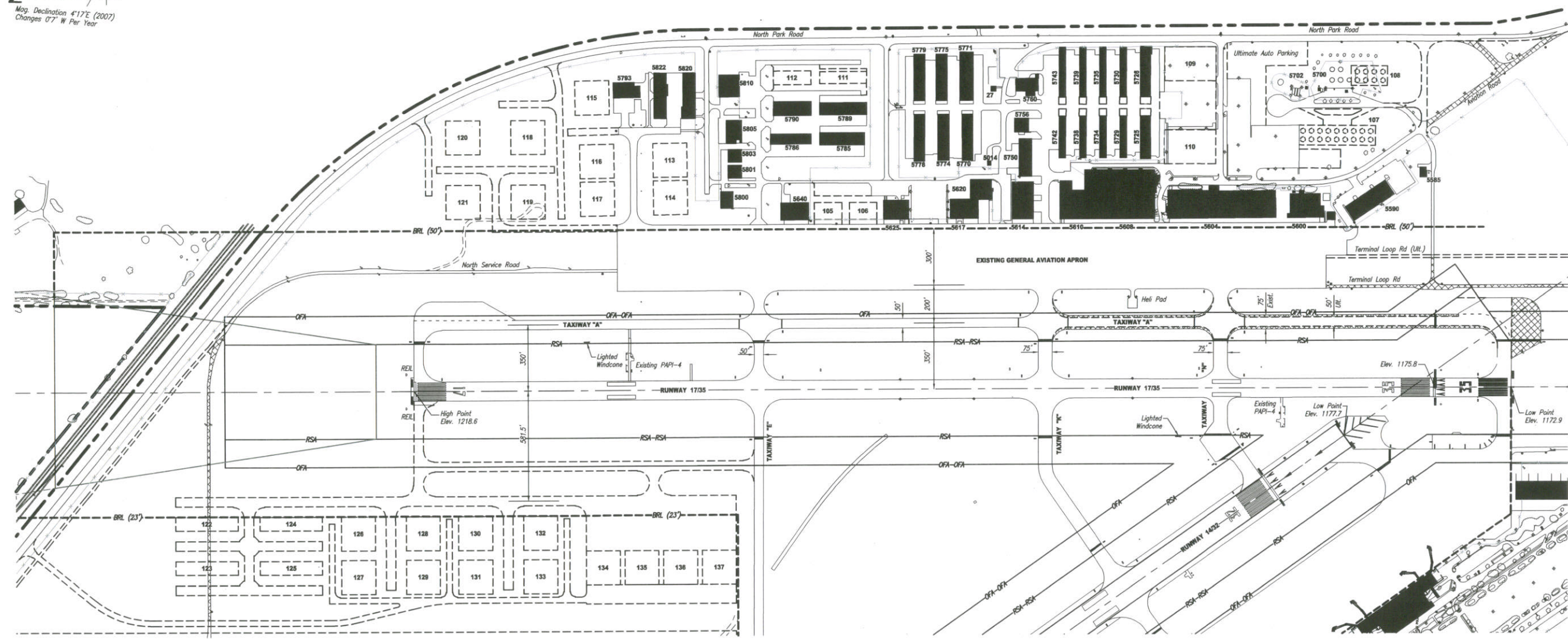

GENERAL AVIATION DRAWING

| GENERAL AVIATION BUILDINGS/FACILITIES | | | GENERAL AVIATION BUILDINGS/FACILITIES | | |
|---------------------------------------|-------------------------------------|--------------------|---------------------------------------|---------------------|--------------------|
| Number | Description | Facility Top Elev. | Number | Description | Facility Top Elev. |
| Exist | Ult. | | Exist | Ult. | |
| 27 | Hazardous Storage | 1215.4 | 5742 | T-Hangar | 1214.4 |
| 5014 | Northeast Vault | 1211.3 | 5743 | T-Hangar | 1215.1 |
| 5585 | East Electrical Vault | 1195.6 | 5750 | T-Hangar | 1221.5 |
| 5590 | General Aviation Building | 1208.5 | 5756 | Corporate Hangar | 1227.4 |
| 5600 | Aircraft Paint Facility | 1234.6 | 5760 | Maintenance Hangar | 1220.8 |
| 5604 | Fixed Base Operation Hangar | 1235.8 | 5770 | T-Hangar | 1225.7 |
| 5608 | Maintenance And Modification Hangar | 1241.2 | 5771 | T-Hangar | 1230.0 |
| 5610 | Maintenance Hangar | 1241.2 | 5774 | T-Hangar | 1228.3 |
| 5614 | Aircraft Paint Facility | 1231.6 | 5775 | T-Hangar | 1229.5 |
| 5617 | Fixed Base Operation Hangar | 1226.2 | 5778 | T-Hangar | 1226.0 |
| 5620 | Fixed Base Operation Hangar | 1226.2 | 5779 | T-Hangar | 1229.0 |
| 5625 | Fixed Base Operation Hangar | 1227.4 | 5785 | T-Hangar | 1236.8 |
| 5640 | Fixed Base Operation Hangar | 1238.1 | 5786 | T-Hangar | 1229.3 |
| 5700 | Fuel Farm | 1215.7 | 5789 | T-Hangar | 1241.0 |
| 5702 | Refueling | 1203.9 | 5790 | T-Hangar | 1235.2 |
| 5725 | T-Hangar | 1213.0 | 5793 | State Patrol Hangar | 1244.5 |
| 5726 | T-Hangar | 1216.0 | 5800 | Corporate Hangar | 1238.0 |
| 5729 | T-Hangar | 1215.1 | 5801 | Corporate Hangar | 1293.3 |
| 5730 | T-Hangar | 1215.1 | 5803 | Corporate Hangar | 1240.7 |
| 5734 | T-Hangar | 1215.2 | 5805 | Corporate Hangar | 1239.6 |
| 5735 | T-Hangar | 1215.2 | 5810 | Corporate Hangar | 1247.6 |
| 5738 | T-Hangar | 1214.9 | 5820 | T-Hangar | 1237.1 |
| 5739 | T-Hangar | 1215.1 | 5822 | T-Hangar | 1237.0 |

| GENERAL AVIATION BUILDINGS/FACILITIES | | |
|---------------------------------------|------------------------------|--------------------|
| Number | Description | Facility Top Elev. |
| Exist | Ult. | |
| 105 | Fixed Base Operations Hangar | - |
| 106 | Fixed Base Operations Hangar | - |
| 107 | Fuel Farm | - |
| 108 | Fuel Farm | - |
| 109 | Fixed Base Operations Hangar | - |
| 110 | Fixed Base Operations Hangar | - |
| 111 | T-Hangar | - |
| 112 | T-Hangar | - |
| 113 | Aviation Related Parcel | N/A |
| 114 | Aviation Related Parcel | N/A |
| 115 | Aviation Related Parcel | N/A |
| 116 | Aviation Related Parcel | N/A |
| 117 | Aviation Related Parcel | N/A |
| 118 | Aviation Related Parcel | N/A |
| 119 | Aviation Related Parcel | N/A |
| 120 | Aviation Related Parcel | N/A |
| 121 | Aviation Related Parcel | N/A |

| GENERAL AVIATION BUILDINGS/FACILITIES | | |
|---------------------------------------|------------------|--------------------|
| Number | Description | Facility Top Elev. |
| Exist | Ult. | |
| 122 | T-Hangar | - |
| 123 | T-Hangar | - |
| 124 | T-Hangar | - |
| 125 | T-Hangar | - |
| 126 | Executive Hangar | - |
| 127 | Executive Hangar | - |
| 128 | Executive Hangar | - |
| 129 | Executive Hangar | - |
| 130 | Executive Hangar | - |
| 131 | Executive Hangar | - |
| 132 | Executive Hangar | - |
| 133 | Executive Hangar | - |
| 134 | Executive Hangar | - |
| 135 | Executive Hangar | - |
| 136 | Executive Hangar | - |
| 137 | Executive Hangar | - |



| NO. | REVISIONS | DATE |
|-----|-----------|------|
| | | |
| | | |
| | | |

GENERAL AVIATION DRAWING

LINCOLN AIRPORT
LINCOLN, NEBRASKA

LINCOLN OFFICE
825 S. St. Bz. 80388
Lincoln, NE 68501
(402) 479-2200
www.hms.com



PROJECT: ALP
DATE: August 2007
JOB NO.: 36-7049
SHEET NO.: 17/29

E:\Transportation\367049\Sheet\Sheet17.dwg

F:\Transportation\367049\Sheet\Sheet18.dwg

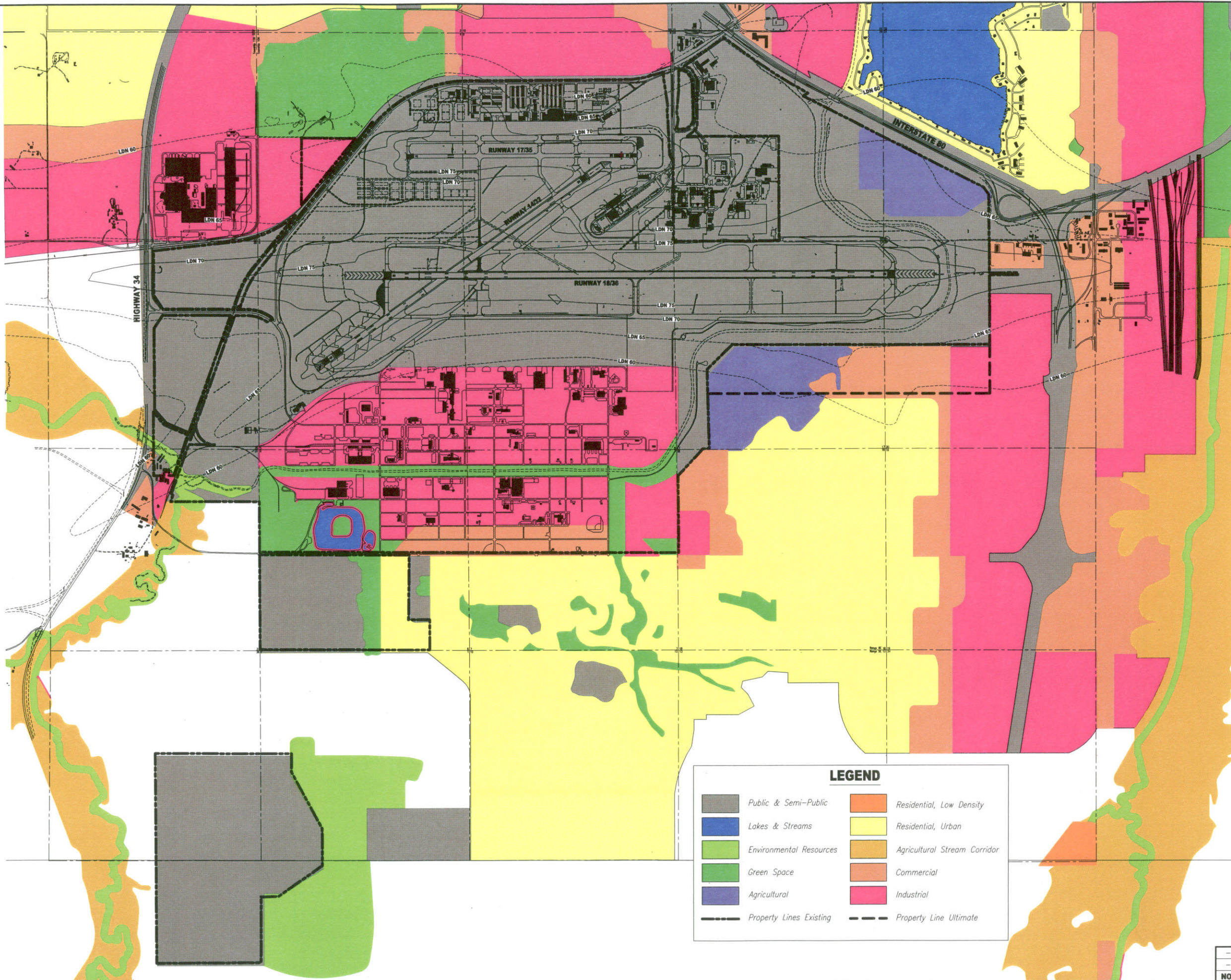

Magn. Declination 4°17'E (2007)
Changes 07" W Per Year

LEGEND

| | | | |
|--|-------------------------|--|------------------------------|
| | Public & Semi-Public | | Residential, Low Density |
| | Lakes & Streams | | Residential, Urban |
| | Environmental Resources | | Agricultural Stream Corridor |
| | Green Space | | Commercial |
| | Agricultural | | Industrial |
| | Property Lines Existing | | Property Line Ultimate |

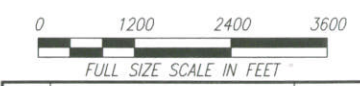

| FULL SIZE SCALE IN FEET | | |
|-------------------------|-----------|------|
| NO. | REVISIONS | DATE |
| | | |
| | | |

LAND USE DRAWING

**LINCOLN AIRPORT
LINCOLN, NEBRASKA**

LINCOLN OFFICE
825 J. St., Box 80308
Lincoln, NE 68501
(402) 479-2200
www.fms.com



| | |
|-----------|----------|
| PROJECT | ALP |
| DATE | May 2007 |
| JOB NO. | 36-7049 |
| SHEET NO. | 18/29 |

PROPERTY ACQUISITION DATA

| TRACT NO. | FAA PROJECT NO. | PROPERTY INTEREST | ACQUISITION OR RELEASE DATE | ACRES |
|-----------|-------------------------|-------------------|-----------------------------|---------|
| 1 | ORIGINAL QUITCLAIM DEED | ORIGINAL PURCHASE | 1959 | 2957 ± |
| 2 | ORIGINAL QUITCLAIM DEED | ORIGINAL PURCHASE | 1959 | 43.91 |
| 4 | ORIGINAL QUITCLAIM DEED | ORIGINAL PURCHASE | 1959 | 217 ± |
| 5 | ORIGINAL QUITCLAIM DEED | ORIGINAL PURCHASE | 1959 | 420 ± |
| 6 | 9-25-055-C303 | FEE SIMPLE | 1963 | 442.94 |
| 7 | 9-25-055-C303 | FEE SIMPLE | 1963 | 6.59 |
| 8 | 8-31-0050-01 | FEE SIMPLE | 1971 | 53.79 |
| 9 | 8-31-0050-02 | FEE SIMPLE | 1971 | 18.50 |
| 10 | 8-31-0050-03 | FEE SIMPLE | 1974 | 49.32 |
| 11 | 3-31-0050-01 | FEE SIMPLE | 1983 | 86.28 |
| 12 | 3-31-0050-02 | FEE SIMPLE | 1983 | 30.61 |
| 13 | 3-31-0050-02 | FEE SIMPLE | 1983 | 65.61 |
| 14 | 3-31-0050-02 | FEE SIMPLE | 1983 | 65.15 |
| 15 | 3-31-0050-02 | FEE SIMPLE | 1983 | 45.34 |
| 16 | 3-31-0050-04 | FEE SIMPLE | 1985 | 7.20 |
| 17 | 3-31-0050-04 | FEE SIMPLE | 1985 | 2.71 |
| 18 | 3-31-0050-04 | FEE SIMPLE | 1985 | 69.79 |
| 19 | 3-31-0050-04 | FEE SIMPLE | 1985 | 0.72 |
| 20 | 3-31-0050-04 | FEE SIMPLE | 1985 | 4.94 |
| 21 | 3-31-0050-04 | FEE SIMPLE | 1985 | 6.13 |
| 22 | N/A | FEE SIMPLE | 1990 | 72.81 |
| 23 | N/A | FEE SIMPLE | 1992 | 22 ± |
| 24 | N/A | FEE SIMPLE | 1995 | 26.3 ± |
| 25 | N/A | FUTURE FEE | - | 123.2 ± |
| 26 | N/A | FUTURE FEE | - | 75.2 ± |

EXISTING EASEMENT DATA

| TRACT NO. | FAA PROJECT NO. | PROPERTY INTEREST | ACQUISITION OR RELEASE DATE | ACRES |
|-----------|-------------------------|-------------------|-----------------------------|---------|
| A | ORIGINAL QUITCLAIM DEED | EASEMENT | 1962 | 64.9 ± |
| B | ORIGINAL QUITCLAIM DEED | EASEMENT | 1969 | 26.5 ± |
| C | 8-31-0050-02 | EASEMENT | 1960 | 127.2 ± |
| D | 9-25-055-C303 | EASEMENT | 1960 | 3.3 ± |

PROPERTY LEGEND

| | |
|--|---|
| | Existing Property Boundary Line |
| | Ultimate Property Boundary Line |
| | Tract Boundary Line |
| | Property Purchased Originally |
| | Property Purchased With Federal Funds |
| | Property Purchased With Non-Federal Funds |
| | Easement Purchased With Federal Funds |
| | Easement Purchased With Non-Federal Funds |
| | Property For Future Purchase |

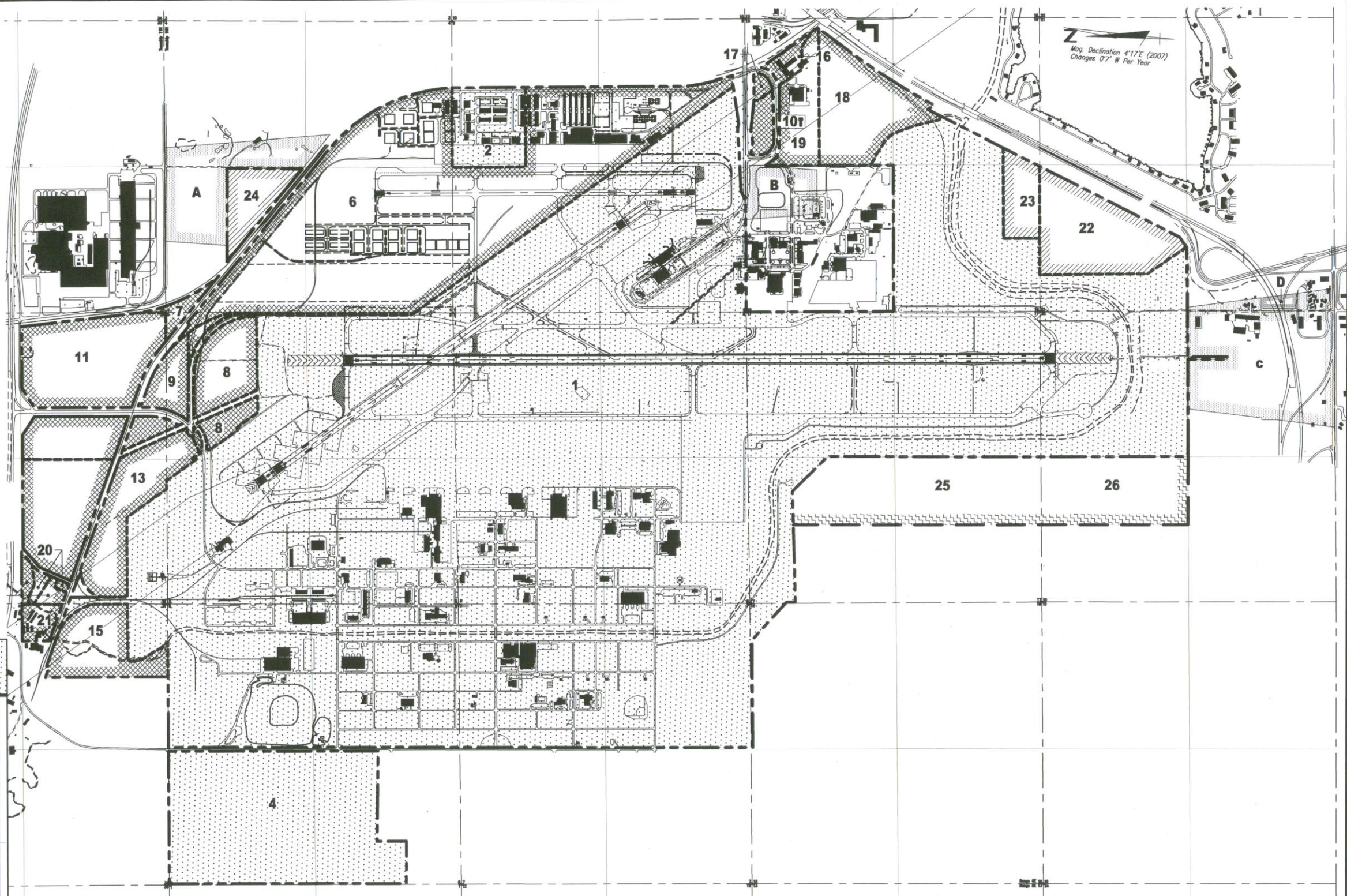

AIRPORT PROPERTY MAP

**LINCOLN AIRPORT
LINCOLN, NEBRASKA**

LINCOLN OFFICE
625 J. St., Box 80388
Lincoln, NE 68501
(402) 479-2200
www.fms.com



PROJECT: ALP
DATE: August 2007
JOB NO.: 36-7049
SHEET NO.: 19/29

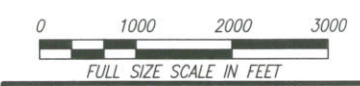

| NO. | REVISIONS | DATE |
|-----|-----------|------|
| | | |

C:\Transportation\367049\Sheet19.dwg

Mag. Declination 4°17'E (2007)
Changes 0'7" W Per Year

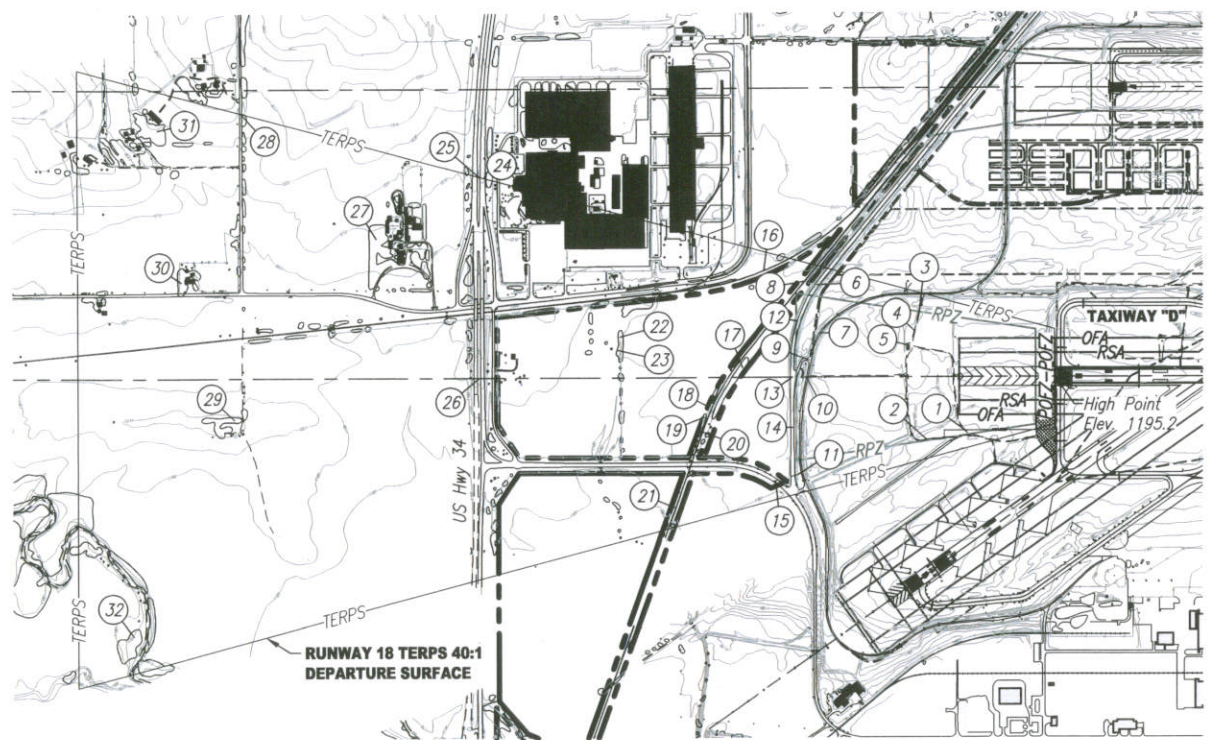

RUNWAY 18 TERPS 40:1 DEPARTURE SURFACE

| OBJECT NO./ DESCRIPTION | OBJECT ELEVATION | 40:1 TERPS DEPART. SURFACE ELEVATION | RUNWAY 18 END (40:1) | | PROPOSED DISPOSITION |
|----------------------------|------------------|---|----------------------|----------------|-------------------------|
| | | | 'C'=Clears | 'OB'=Obstructs | |
| 1 Service Road | 1201.9 | 1219.0 | 17.1 | 'C' | |
| 2 Service Road | 1201.9 | 1228.7 | 26.9 | 'C' | |
| 3 North Service Road | 1204.5 | 1230.6 | 26.1 | 'C' | |
| 4 Service Road | 1203.8 | 1231.8 | 28.0 | 'C' | |
| 5 Service Road | 1203.6 | 1233.1 | 29.5 | 'C' | |
| 6 North Park Road | 1220.0 | 1257.3 | 37.3 | 'C' | |
| 7 North Service Road | 1208.3 | 1256.8 | 48.5 | 'C' | |
| 8 Rail Road | 1222.1 | 1260.6 | 38.5 | 'C' | |
| 9 North Service Road | 1209.5 | 1259.4 | 49.9 | 'C' | |
| 10 North Service Road | 1209.9 | 1260.1 | 50.2 | 'C' | |
| 11 Perimeter Fence | 1213.2 | 1262.3 | 49.2 | 'C' | |
| 12 North Park Road | 1217.9 | 1262.4 | 44.5 | 'C' | |
| 13 North Park Road | 1214.7 | 1263.8 | 49.1 | 'C' | |
| 14 North Park Road | 1212.6 | 1263.8 | 51.2 | 'C' | |
| 15 Airport Road | 1212.2 | 1268.2 | 56.0 | 'C' | |
| 16 UP Rail Road | 1222.0 | 1271.2 | 49.2 | 'C' | |
| 17 Tree Top | 1227.2 | 1276.9 | 49.7 | 'C' | |
| 18 Tree Top | 1224.6 | 1285.8 | 61.2 | 'C' | |
| 19 Tree Top | 1238.0 | 1286.9 | 48.9 | 'C' | |
| 20 Tree Top | 1212.1 | 1287.9 | 75.8 | 'C' | |
| 21 BN Rail Road | 1210.2 | 1294.3 | 84.1 | 'C' | |
| 22 Tree Top | 1222.3 | 1308.6 | 86.3 | 'C' | |
| 23 Tree Top | 1220.8 | 1309.3 | 88.5 | 'C' | |
| 24 Building | 1258.2 | 1319.9 | 61.7 | 'C' | |
| 25 US Hwy 34 | 1223.1 | 1345.4 | 122.3 | 'C' | |
| 26 US Hwy 34 | 1228.4 | 1345.4 | 116.9 | 'C' | |
| 27 Tree Top | 1266.6 | 1372.2 | 105.6 | 'C' | |
| 28 Road | 1238.2 | 1407.6 | 169.3 | 'C' | |
| 29 Tree Top | 1267.1 | 1409.4 | 142.3 | 'C' | |
| 30 Tree Top | 1247.3 | 1423.4 | 176.1 | 'C' | |
| 31 Tree Top | 1289.7 | 1429.4 | 139.7 | 'C' | |
| 32 Tree Top | 1255.0 | 1435.9 | 180.9 | 'C' | |

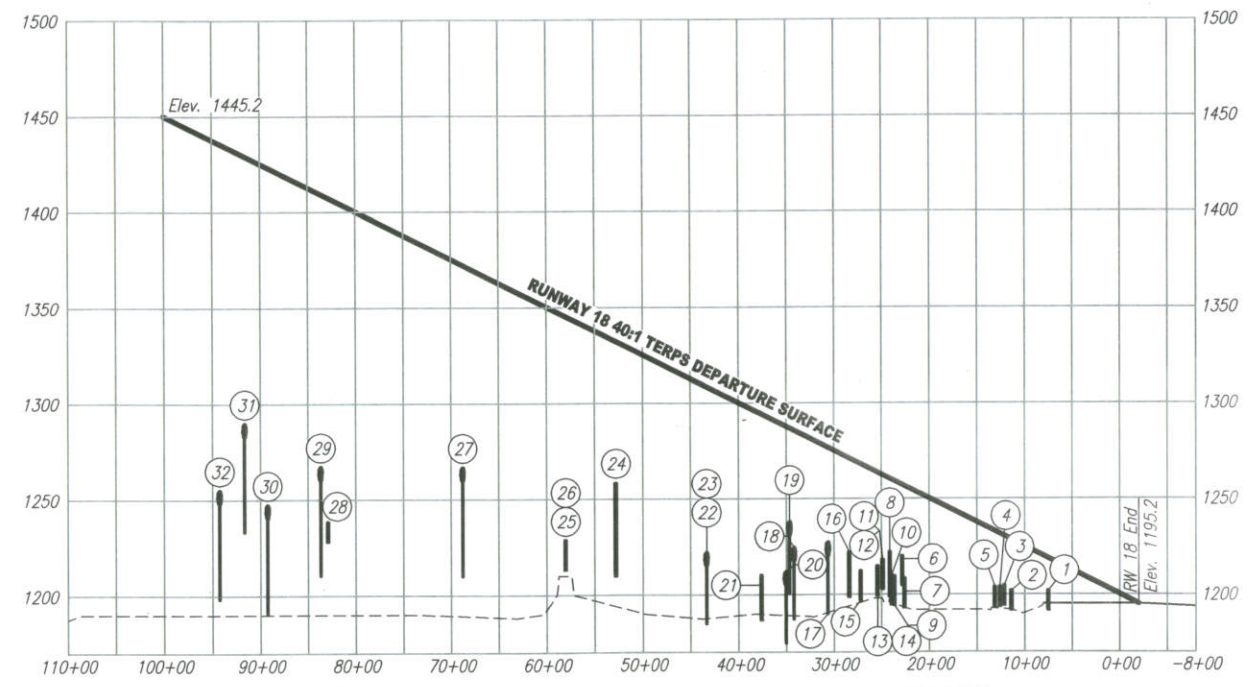

RUNWAY 18 TERPS 40:1 DEPARTURE SURFACE

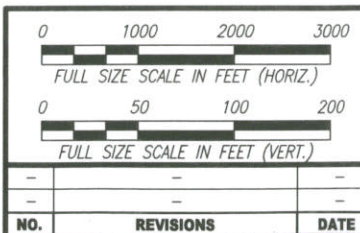

**RUNWAY 18 TERPS 40-1
DEPARTURE SURFACE**

**LINCOLN AIRPORT
LINCOLN, NEBRASKA**

LINCOLN OFFICE
825 J St., Box 80358
Lincoln, NE 68501
(402) 479-2200
www.hws.com



PROJECT: ALP
DATE: August 2007
JOB NO.: 36-7049
SHEET NO.: 20/29

F:\Transportation\367049\Sheet\Sheet20.dwg

Mag. Declination 4°17'E (2007)
Changes 0°7' W Per Year

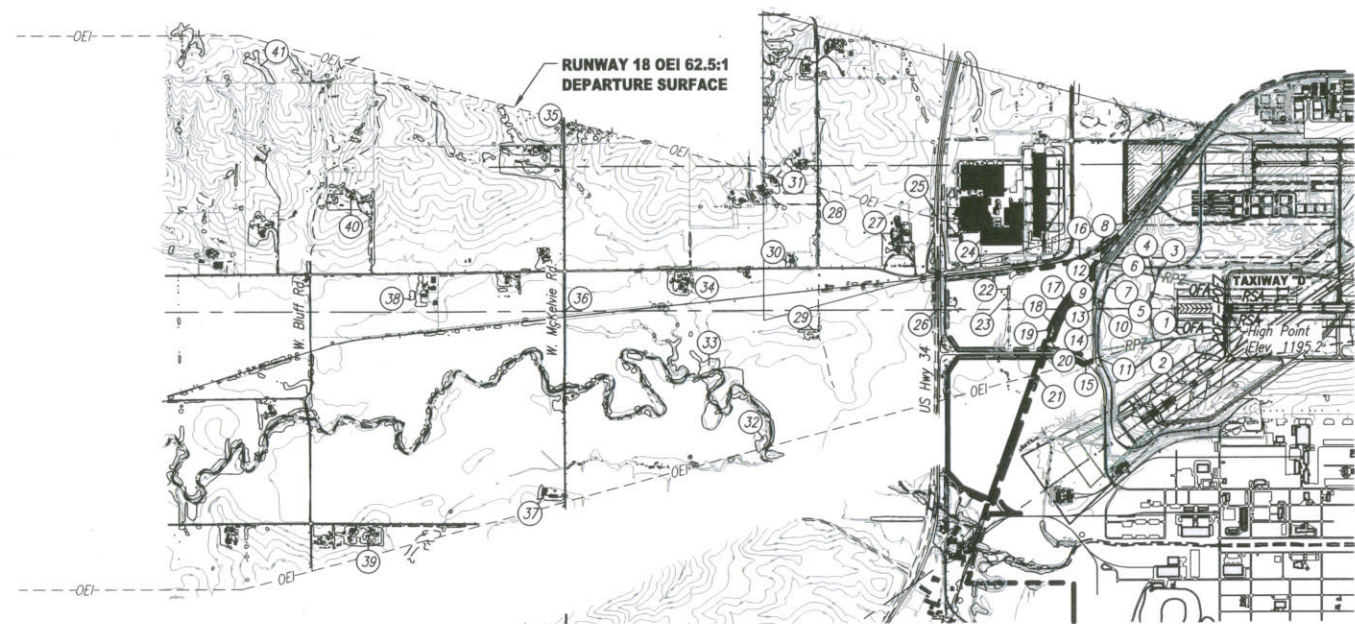

RUNWAY 18 OEI 62.5:1 DEPARTURE SURFACE

| 62.5:1 OEI DEPARTURE SURFACE OBSTRUCTION TABLE | | | RUNWAY 18 END (62.5:1) | | |
|--|------------------|--------------------------------------|------------------------|----------------|----------------------|
| OBJECT NO./ DESCRIPTION | OBJECT ELEVATION | 62.5:1 OEI DEPART. SURFACE ELEVATION | OBJECT PENETRATION | | PROPOSED DISPOSITION |
| | | | 'C'=Clears | 'OB'=Obstructs | |
| 1 Service Road | 1201.9 | 1210.4 | 8.5 | 'C' | - |
| 2 Service Road | 1201.9 | 1216.7 | 14.8 | 'C' | - |
| 3 North Service Road | 1204.5 | 1217.9 | 13.4 | 'C' | - |
| 4 Service Road | 1203.8 | 1218.6 | 14.8 | 'C' | - |
| 5 Service Road | 1203.6 | 1219.4 | 15.8 | 'C' | - |
| 6 North Park Road | 1220.0 | 1234.9 | 15.0 | 'C' | - |
| 7 North Service Road | 1208.3 | 1234.6 | 26.3 | 'C' | - |
| 8 Rail Road | 1222.1 | 1237.1 | 14.9 | 'C' | - |
| 9 North Service Road | 1209.5 | 1236.3 | 26.8 | 'C' | - |
| 10 North Service Road | 1209.9 | 1236.7 | 26.8 | 'C' | - |
| 11 Perimeter Fence | 1213.2 | 1238.2 | 25.0 | 'C' | - |
| 12 North Park Road | 1217.9 | 1238.2 | 20.3 | 'C' | - |
| 13 North Park Road | 1214.7 | 1239.1 | 24.4 | 'C' | - |
| 14 North Park Road | 1212.6 | 1239.1 | 26.5 | 'C' | - |
| 15 Airport Road | 1212.2 | 1241.9 | 29.7 | 'C' | - |
| 16 UP Rail Road | 1222.0 | 1243.8 | 21.8 | 'C' | - |
| 17 Tree Top | 1227.2 | 1247.5 | 20.3 | 'C' | - |
| 18 Tree Top | 1224.6 | 1253.2 | 28.6 | 'C' | - |
| 19 Tree Top | 1238.0 | 1253.9 | 15.9 | 'C' | - |
| 20 Tree Top | 1212.1 | 1254.5 | 42.4 | 'C' | - |
| 21 BN Rail Road | 1210.2 | 1258.6 | 48.4 | 'C' | - |
| 22 Tree Top | 1222.3 | 1267.8 | 45.5 | 'C' | - |
| 23 Tree Top | 1220.8 | 1268.2 | 47.4 | 'C' | - |
| 24 Building | 1258.2 | 1275.0 | 16.8 | 'C' | - |
| 25 US Hwy 34 | 1223.1 | 1291.3 | 68.2 | 'C' | - |
| 26 US Hwy 34 | 1228.4 | 1291.3 | 62.9 | 'C' | - |
| 27 Tree Top | 1266.6 | 1308.5 | 41.9 | 'C' | - |
| 28 Road | 1238.2 | 1331.1 | 92.9 | 'C' | - |
| 29 Tree Top | 1267.1 | 1332.3 | 65.2 | 'C' | - |
| 30 Tree Top | 1247.3 | 1341.2 | 93.9 | 'C' | - |
| 31 Tree Top | 1289.7 | 1345.1 | 55.4 | 'C' | - |
| 32 Tree Top | 1255.0 | 1349.2 | 94.2 | 'C' | - |
| 33 Tree Top | 1262.2 | 1367.4 | 105.2 | 'C' | - |
| 34 Tree Top | 1257.8 | 1375.4 | 117.6 | 'C' | - |
| 35 Tree Top | 1324.4 | 1415.2 | 90.8 | 'C' | - |
| 36 W. McKelvie Rd. | 1204.5 | 1415.8 | 211.4 | 'C' | - |
| 37 Tree Top | 1252.3 | 1423.1 | 170.8 | 'C' | - |
| 38 Tree Top | 1263.9 | 1467.7 | 203.8 | 'C' | - |
| 39 Tree Top | 1281.2 | 1481.9 | 200.7 | 'C' | - |
| 40 Tree Top | 1338.9 | 1487.2 | 148.3 | 'C' | - |
| 41 Tree Top | 1375.5 | 1517.2 | 141.7 | 'C' | - |

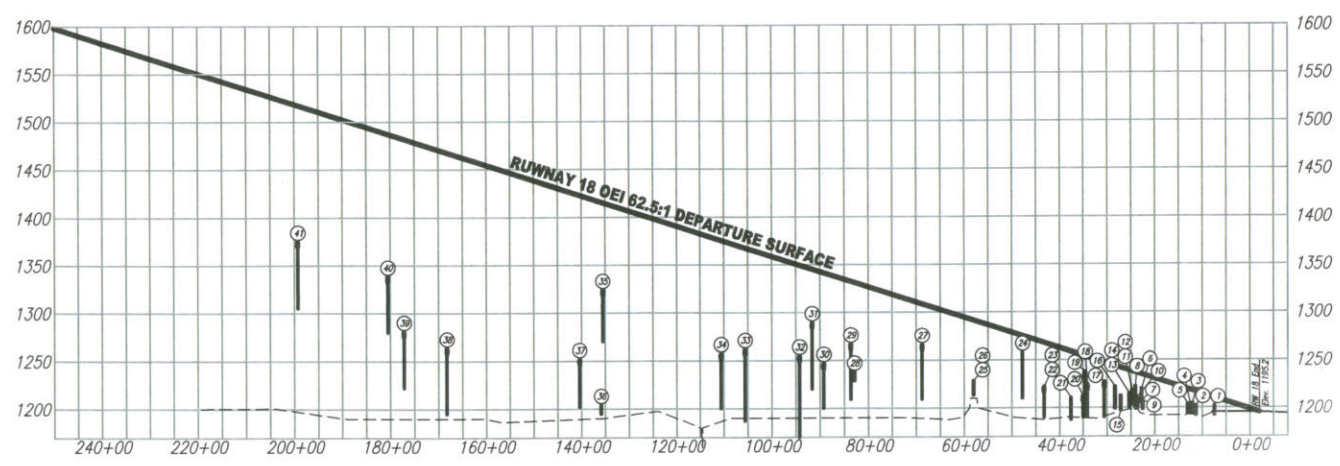

RUNWAY 18 OEI 62.5:1 DEPARTURE SURFACE

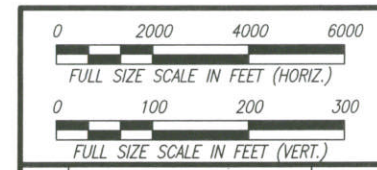

| NO. | REVISIONS | DATE |
|-----|-----------|------|
| - | - | - |
| - | - | - |

RUNWAY 18 OEI 62.5-1 DEPARTURE SURFACE

**LINCOLN AIRPORT
LINCOLN, NEBRASKA**

LINCOLN OFFICE
825 J St., Box 80388
Lincoln, NE 68501
(402) 479-2200
www.hmc.com



PROJECT: ALP
DATE: August 2007
JOB NO.: 36-7049
SHEET NO.: 21/29

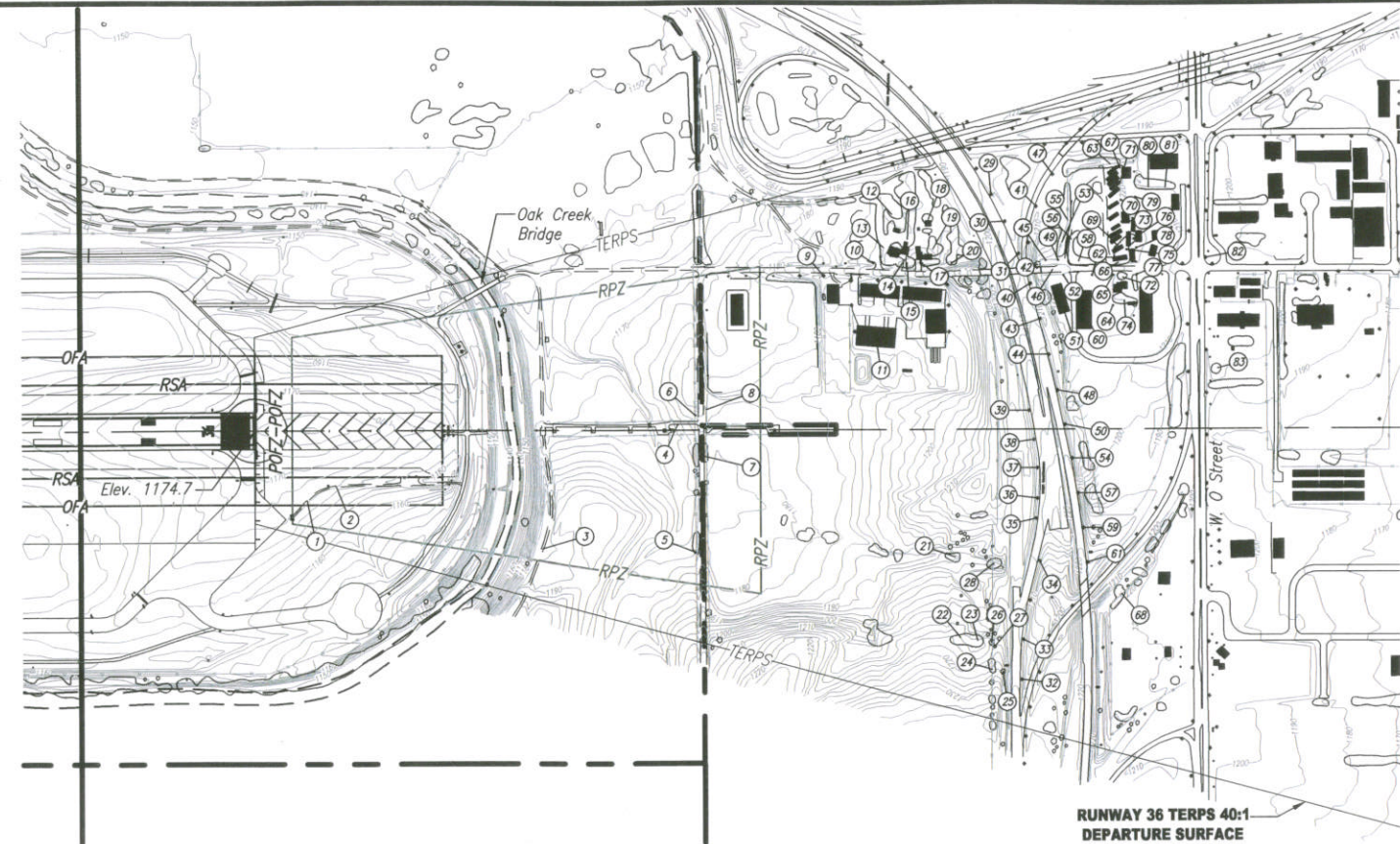

DETAIL A PLAN VIEW

Scale 1" = 500'

Mag. Declination 4°17'E (2007)
Changes 07" W Per Year

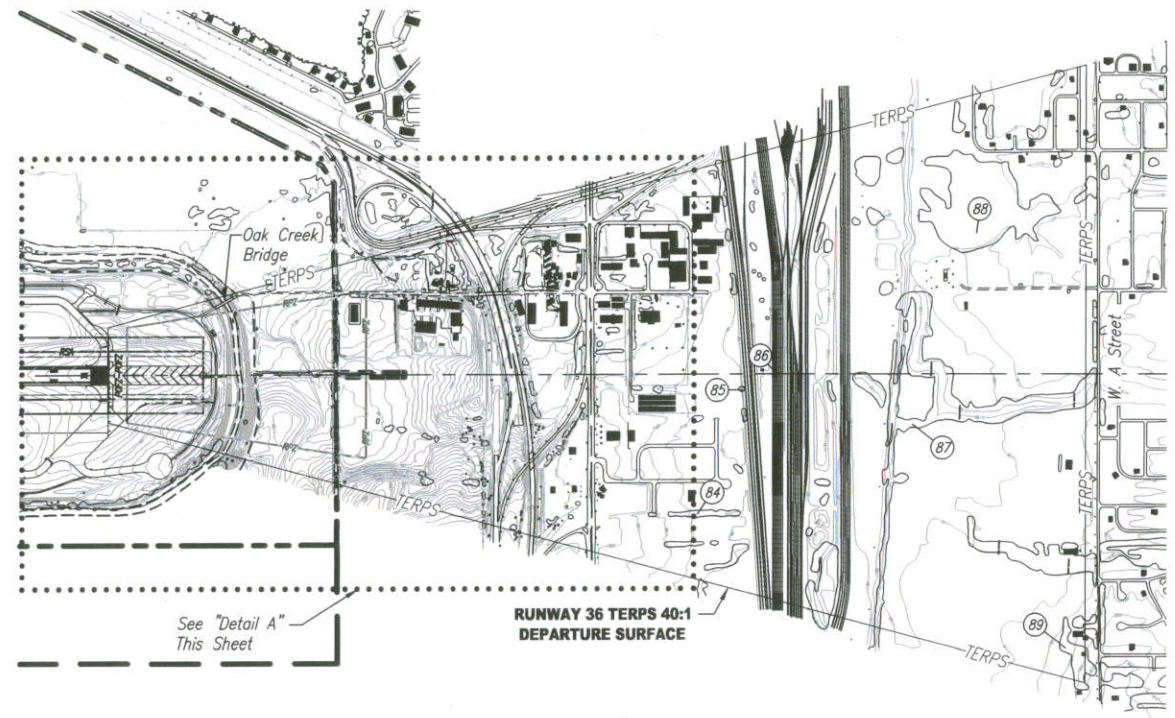

RUNWAY 36 TERPS 40:1 DEPARTURE SURFACE

RUNWAY 36 TERPS 40-1 DEPARTURE SURFACE

**LINCOLN AIRPORT
LINCOLN, NEBRASKA**

LINCOLN OFFICE
825 S. St., Box 80388
Lincoln, NE 68501
(402) 479-2200
www.hws.com



PROJECT: ALP
DATE: August 2007
JOB NO.: 36-7049
SHEET NO.: 22/29

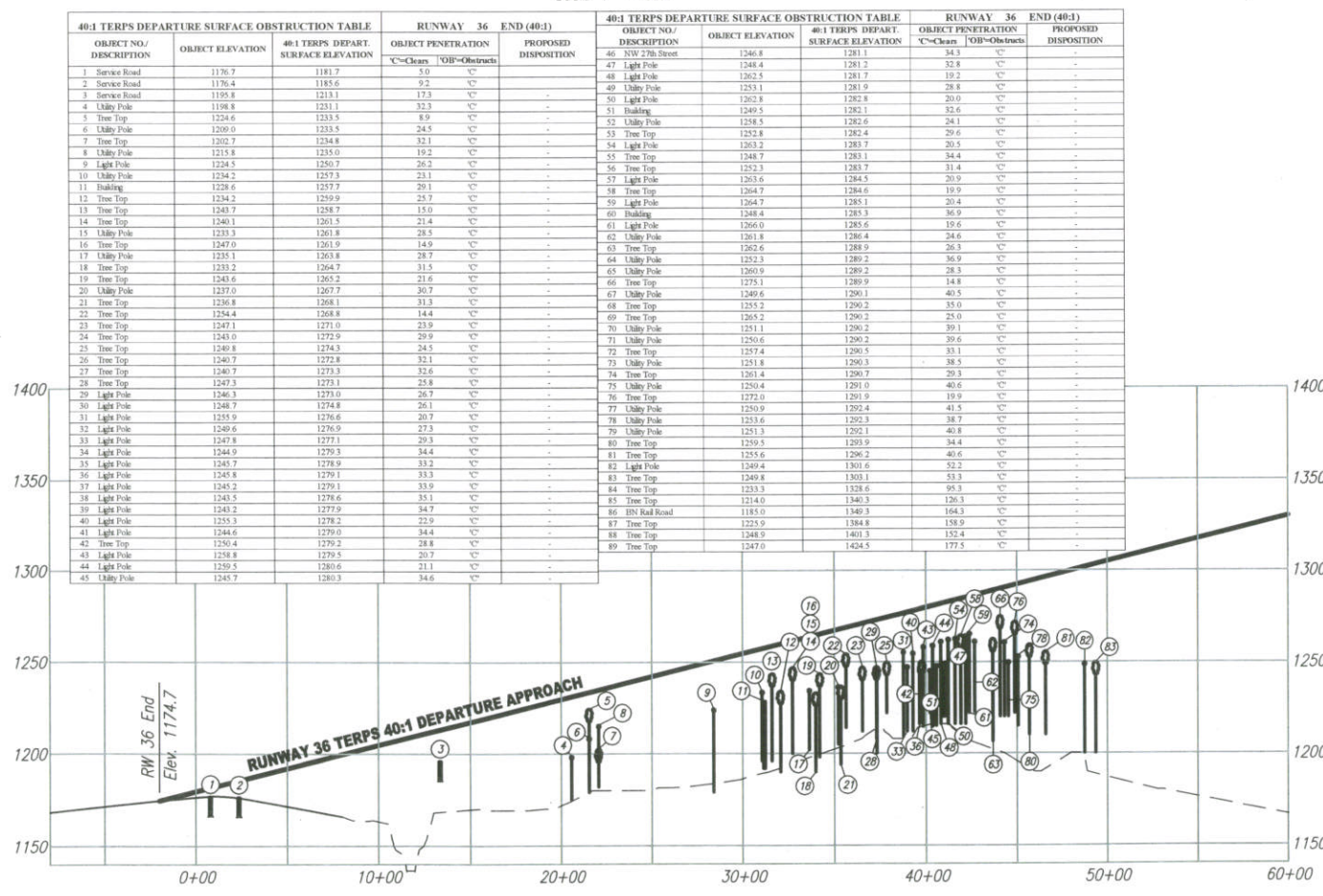

DETAIL A PROFILE VIEW

Scale 1" = 500' (Horiz.)
1" = 50' (Vert.)

NOTE: All Objects in Plan View Are Not Shown in Profile View. See Table on This Sheet.

| 40:1 TERPS DEPARTURE SURFACE OBSTRUCTION TABLE | | | | | RUNWAY 36 END (40:1) | | | | | 40:1 TERPS DEPARTURE SURFACE OBSTRUCTION TABLE | | | | | RUNWAY 36 END (40:1) | | | | |
|--|------------------|--------------------------------------|--------------------|----------|----------------------|------------------------|------------------|--------------------------------------|--------------------|--|----------------------|------------------------|------------------|--------------------------------------|----------------------|----------|----------------------|--|--|
| OBJECT NO./DESCRIPTION | OBJECT ELEVATION | 40:1 TERPS DEPART. SURFACE ELEVATION | OBJECT PENETRATION | | PROPOSED DISPOSITION | OBJECT NO./DESCRIPTION | OBJECT ELEVATION | 40:1 TERPS DEPART. SURFACE ELEVATION | OBJECT PENETRATION | | PROPOSED DISPOSITION | OBJECT NO./DESCRIPTION | OBJECT ELEVATION | 40:1 TERPS DEPART. SURFACE ELEVATION | OBJECT PENETRATION | | PROPOSED DISPOSITION | | |
| | | | Clear | Obstruct | | | | | Clear | Obstruct | | | | | Clear | Obstruct | | | |
| 1 Service Road | 1176.7 | 1181.7 | 5.0 | ✓ | - | 46 NW 27th Street | 1246.8 | 1281.1 | 34.3 | ✓ | - | 47 Light Pole | 1248.4 | 1281.2 | 32.8 | ✓ | - | | |
| 2 Service Road | 1176.4 | 1185.6 | 9.2 | ✓ | - | 48 Light Pole | 1262.5 | 1281.7 | 19.2 | ✓ | - | 49 Utility Pole | 1251.1 | 1281.9 | 28.8 | ✓ | - | | |
| 3 Service Road | 1195.8 | 1213.1 | 17.3 | ✓ | - | 50 Light Pole | 1262.8 | 1282.8 | 20.0 | ✓ | - | 51 Building | 1249.5 | 1282.1 | 32.6 | ✓ | - | | |
| 4 Utility Pole | 1198.6 | 1231.1 | 32.5 | ✓ | - | 52 Utility Pole | 1248.5 | 1282.6 | 24.1 | ✓ | - | 53 Tree Top | 1252.8 | 1282.4 | 29.6 | ✓ | - | | |
| 5 Tree Top | 1224.6 | 1233.5 | 8.9 | ✓ | - | 54 Light Pole | 1283.2 | 1283.7 | 0.5 | ✓ | - | 55 Tree Top | 1248.7 | 1283.1 | 34.4 | ✓ | - | | |
| 6 Utility Pole | 1209.0 | 1233.5 | 24.5 | ✓ | - | 56 Tree Top | 1252.3 | 1283.7 | 31.4 | ✓ | - | 57 Light Pole | 1263.6 | 1284.5 | 20.9 | ✓ | - | | |
| 7 Tree Top | 1202.7 | 1234.8 | 32.1 | ✓ | - | 58 Tree Top | 1264.7 | 1284.6 | 19.9 | ✓ | - | 59 Light Pole | 1264.7 | 1285.1 | 20.4 | ✓ | - | | |
| 8 Utility Pole | 1215.8 | 1235.0 | 19.2 | ✓ | - | 60 Building | 1248.4 | 1285.3 | 36.9 | ✓ | - | 61 Light Pole | 1266.0 | 1285.6 | 19.6 | ✓ | - | | |
| 9 Light Pole | 1224.5 | 1250.7 | 26.2 | ✓ | - | 62 Utility Pole | 1261.8 | 1286.4 | 24.6 | ✓ | - | 63 Tree Top | 1262.9 | 1286.3 | 23.4 | ✓ | - | | |
| 10 Utility Pole | 1234.2 | 1257.3 | 23.1 | ✓ | - | 64 Utility Pole | 1252.3 | 1289.2 | 36.9 | ✓ | - | 65 Utility Pole | 1280.9 | 1289.2 | 8.3 | ✓ | - | | |
| 11 Building | 1228.6 | 1257.7 | 29.1 | ✓ | - | 66 Tree Top | 1275.1 | 1289.9 | 14.8 | ✓ | - | 67 Utility Pole | 1249.6 | 1290.1 | 40.5 | ✓ | - | | |
| 12 Tree Top | 1234.2 | 1259.9 | 25.7 | ✓ | - | 68 Tree Top | 1255.2 | 1290.2 | 35.0 | ✓ | - | 68 Tree Top | 1255.2 | 1290.2 | 35.0 | ✓ | - | | |
| 13 Tree Top | 1243.7 | 1258.7 | 15.0 | ✓ | - | 69 Tree Top | 1265.2 | 1290.2 | 25.0 | ✓ | - | 69 Tree Top | 1265.2 | 1290.2 | 25.0 | ✓ | - | | |
| 14 Tree Top | 1240.1 | 1261.5 | 21.4 | ✓ | - | 70 Utility Pole | 1251.1 | 1290.2 | 39.1 | ✓ | - | 70 Utility Pole | 1251.1 | 1290.2 | 39.1 | ✓ | - | | |
| 15 Utility Pole | 1233.3 | 1261.8 | 28.5 | ✓ | - | 71 Utility Pole | 1250.6 | 1290.2 | 39.6 | ✓ | - | 71 Utility Pole | 1250.6 | 1290.2 | 39.6 | ✓ | - | | |
| 16 Tree Top | 1247.0 | 1261.9 | 14.9 | ✓ | - | 72 Tree Top | 1257.4 | 1290.5 | 33.1 | ✓ | - | 72 Tree Top | 1257.4 | 1290.5 | 33.1 | ✓ | - | | |
| 17 Utility Pole | 1235.1 | 1263.8 | 28.7 | ✓ | - | 73 Utility Pole | 1251.8 | 1290.3 | 38.5 | ✓ | - | 73 Utility Pole | 1251.8 | 1290.3 | 38.5 | ✓ | - | | |
| 18 Tree Top | 1233.2 | 1264.7 | 31.5 | ✓ | - | 74 Tree Top | 1261.4 | 1290.7 | 29.3 | ✓ | - | 74 Tree Top | 1261.4 | 1290.7 | 29.3 | ✓ | - | | |
| 19 Tree Top | 1244.6 | 1265.2 | 21.6 | ✓ | - | 75 Utility Pole | 1250.4 | 1291.0 | 40.6 | ✓ | - | 75 Utility Pole | 1250.4 | 1291.0 | 40.6 | ✓ | - | | |
| 20 Utility Pole | 1237.0 | 1267.7 | 30.7 | ✓ | - | 76 Tree Top | 1272.0 | 1291.9 | 19.9 | ✓ | - | 76 Tree Top | 1272.0 | 1291.9 | 19.9 | ✓ | - | | |
| 21 Tree Top | 1236.8 | 1268.1 | 31.3 | ✓ | - | 77 Utility Pole | 1250.9 | 1292.4 | 41.5 | ✓ | - | 77 Utility Pole | 1250.9 | 1292.4 | 41.5 | ✓ | - | | |
| 22 Tree Top | 1254.4 | 1268.8 | 14.4 | ✓ | - | 78 Utility Pole | 1253.6 | 1292.3 | 38.7 | ✓ | - | 78 Utility Pole | 1253.6 | 1292.3 | 38.7 | ✓ | - | | |
| 23 Tree Top | 1247.1 | 1271.0 | 23.9 | ✓ | - | 79 Utility Pole | 1251.3 | 1292.1 | 40.8 | ✓ | - | 79 Utility Pole | 1251.3 | 1292.1 | 40.8 | ✓ | - | | |
| 24 Tree Top | 1243.0 | 1272.9 | 29.9 | ✓ | - | 80 Tree Top | 1259.5 | 1293.9 | 34.4 | ✓ | - | 80 Tree Top | 1259.5 | 1293.9 | 34.4 | ✓ | - | | |
| 25 Tree Top | 1249.8 | 1274.3 | 24.5 | ✓ | - | 81 Tree Top | 1254.6 | 1296.2 | 40.6 | ✓ | - | 81 Tree Top | 1254.6 | 1296.2 | 40.6 | ✓ | - | | |
| 26 Tree Top | 1240.7 | 1272.8 | 32.1 | ✓ | - | 82 Light Pole | 1249.4 | 1301.6 | 52.2 | ✓ | - | 82 Light Pole | 1249.4 | 1301.6 | 52.2 | ✓ | - | | |
| 27 Tree Top | 1240.7 | 1273.3 | 32.6 | ✓ | - | 83 Tree Top | 1249.8 | 1303.1 | 53.3 | ✓ | - | 83 Tree Top | 1249.8 | 1303.1 | 53.3 | ✓ | - | | |
| 28 Tree Top | 1247.3 | 1273.1 | 25.8 | ✓ | - | 84 Tree Top | 1253.3 | 1328.6 | 99.3 | ✓ | - | 84 Tree Top | 1253.3 | 1328.6 | 99.3 | ✓ | - | | |
| 29 Light Pole | 1246.0 | 1273.0 | 26.7 | ✓ | - | 85 Tree Top | 1214.0 | 1340.3 | 126.3 | ✓ | - | 85 Tree Top | 1214.0 | 1340.3 | 126.3 | ✓ | - | | |
| 30 Light Pole | 1248.7 | 1274.8 | 26.1 | ✓ | - | 86 HWY Road | 1185.0 | 1340.3 | 164.3 | ✓ | - | 86 HWY Road | 1185.0 | 1340.3 | 164.3 | ✓ | - | | |
| 31 Light Pole | 1255.9 | 1276.6 | 20.7 | ✓ | - | 87 Tree Top | 1225.9 | 1384.8 | 158.9 | ✓ | - | 87 Tree Top | 1225.9 | 1384.8 | 158.9 | ✓ | - | | |
| 32 Light Pole | 1249.6 | 1276.9 | 27.3 | ✓ | - | 88 Tree Top | 1248.9 | 1401.3 | 152.4 | ✓ | - | 88 Tree Top | 1248.9 | 1401.3 | 152.4 | ✓ | - | | |
| 33 Light Pole | 1247.8 | 1277.1 | 29.3 | ✓ | - | 89 Tree Top | 1247.0 | 1424.5 | 177.5 | ✓ | - | 89 Tree Top | 1247.0 | 1424.5 | 177.5 | ✓ | - | | |
| 34 Light Pole | 1244.9 | 1279.3 | 34.4 | ✓ | - | | | | | | | | | | | | | | |
| 35 Light Pole | 1245.7 | 1278.9 | 33.2 | ✓ | - | | | | | | | | | | | | | | |
| 36 Light Pole | 1245.8 | 1279.1 | 33.3 | ✓ | - | | | | | | | | | | | | | | |
| 37 Light Pole | 1245.2 | 1279.1 | 33.9 | ✓ | - | | | | | | | | | | | | | | |
| 38 Light Pole | 1243.5 | 1278.6 | 35.1 | ✓ | - | | | | | | | | | | | | | | |
| 39 Light Pole | 1243.2 | 1277.9 | 34.7 | ✓ | - | | | | | | | | | | | | | | |
| 40 Light Pole | 1255.3 | 1278.2 | 22.9 | ✓ | - | | | | | | | | | | | | | | |
| 41 Light Pole | 1244.6 | 1279.0 | 34.4 | ✓ | - | | | | | | | | | | | | | | |
| 42 Tree Top | 1250.4 | 1279.2 | 28.8 | ✓ | - | | | | | | | | | | | | | | |
| 43 Light Pole | 1258.8 | 1279.5 | 20.7 | ✓ | - | | | | | | | | | | | | | | |
| 44 Light Pole | 1259.5 | 1280.6 | 21.1 | ✓ | - | | | | | | | | | | | | | | |
| 45 Utility Pole | 1245.7 | 1280.3 | 34.6 | ✓ | - | | | | | | | | | | | | | | |

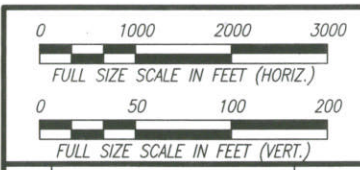

| NO. | REVISIONS | DATE |
|-----|-----------|------|
| | | |

F:\Transportation\367049\Sheet\Sheet22.dwg

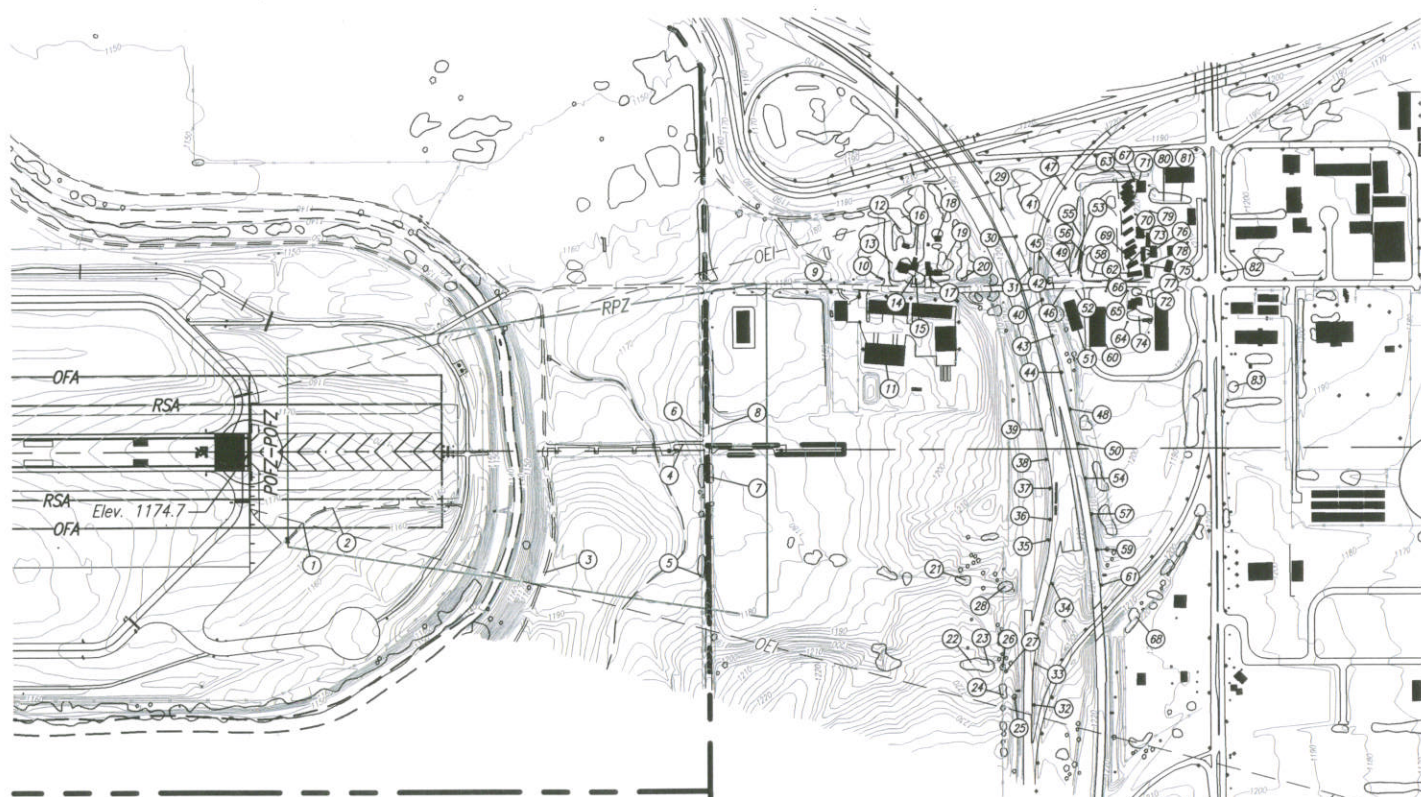

DETAIL A PLAN VIEW

Scale 1" = 500'

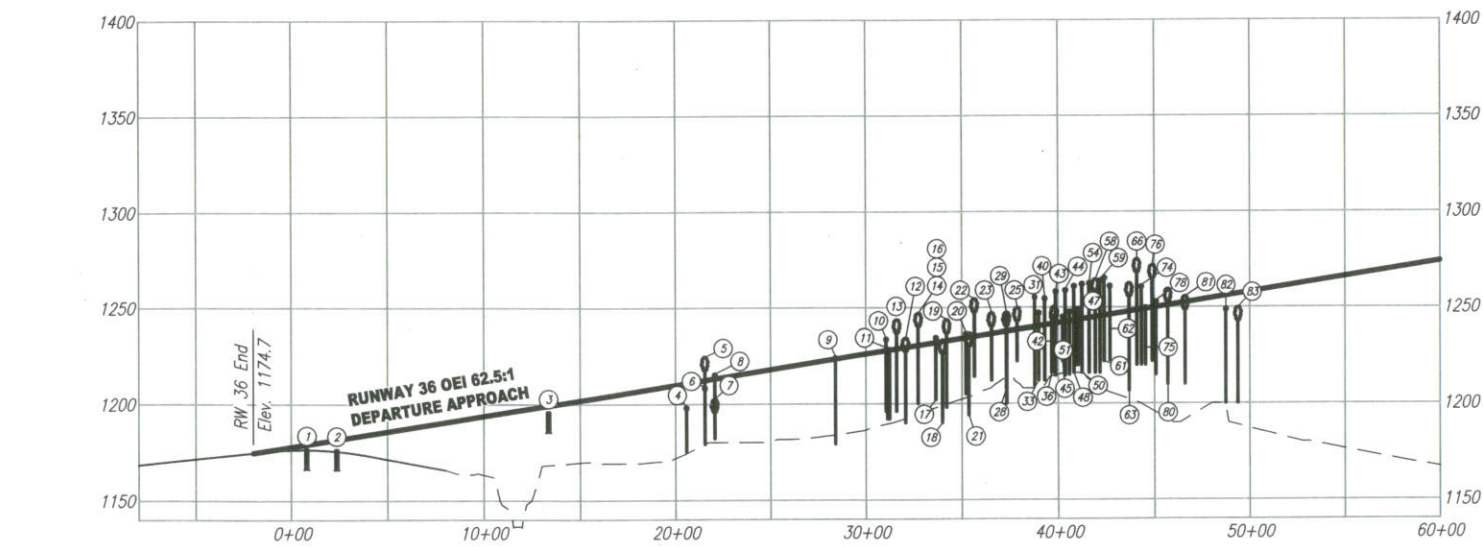

DETAIL A PROFILE VIEW

Scale 1" = 500' (Horiz.)
1" = 50' (Vert.)

NOTE: All Objects In Plan View Are Not Shown In Profile View. See Table On This Sheet.

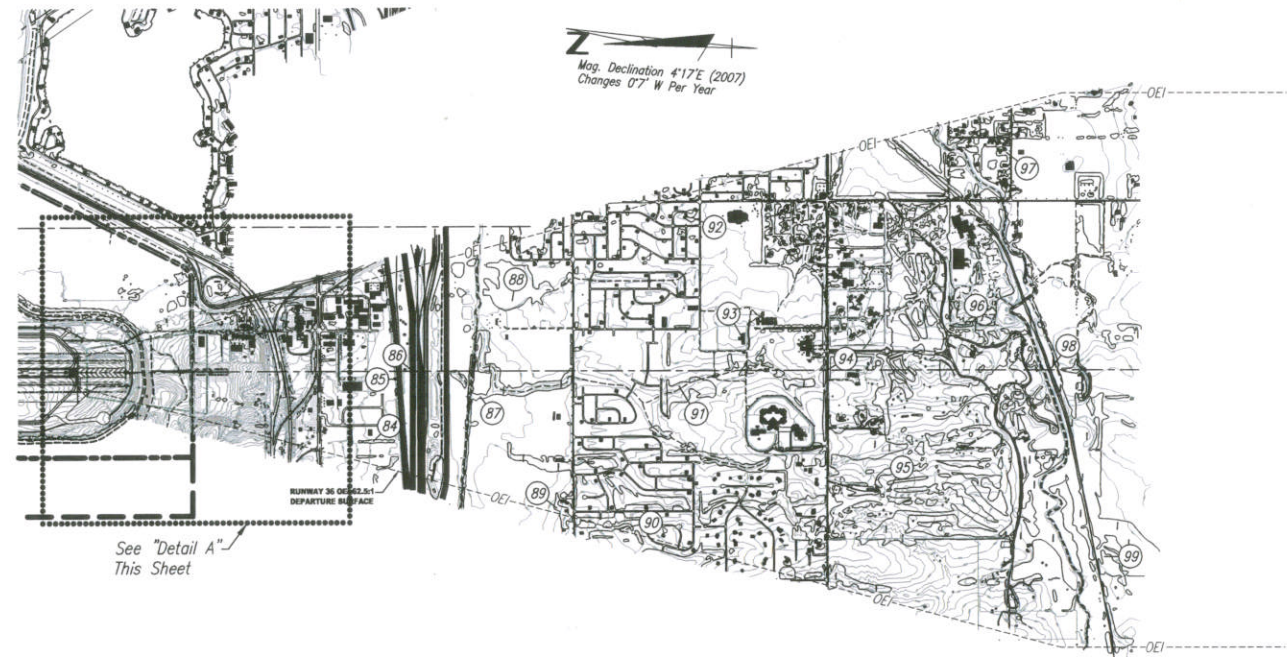

See "Detail A" This Sheet

RUNWAY 36 OEI 62.5:1 DEPARTURE SURFACE

| 62.5:1 OEI DEPARTURE SURFACE OBSTRUCTION TABLE | | | | 62.5:1 OEI DEPARTURE SURFACE OBSTRUCTION TABLE | | | | | |
|--|------------------|--------------------------------------|--|--|------------------------|------------------|--------------------------------------|--|----------------------|
| OBJECT NO./DESCRIPTION | OBJECT ELEVATION | 62.5:1 OEI DEPART. SURFACE ELEVATION | OBJECT PENETRATION "C"=Clears "V"=Obstructs | PROPOSED DISPOSITION | OBJECT NO./DESCRIPTION | OBJECT ELEVATION | 62.5:1 OEI DEPART. SURFACE ELEVATION | OBJECT PENETRATION "C"=Clears "V"=Obstructs | PROPOSED DISPOSITION |
| 1 Service Road | 1176.7 | 1179.2 | 2.5 | "C" | 51 Building | 1249.5 | 1243.5 | -6.0 | "V" |
| 2 Service Road | 1176.4 | 1181.7 | 5.3 | "C" | 52 Utility Pole | 1258.5 | 1243.7 | -14.8 | "V" |
| 3 Service Road | 1195.8 | 1199.3 | 3.5 | "C" | 53 Tree Top | 1252.8 | 1243.6 | -9.2 | "V" |
| 4 Utility Pole | 1198.8 | 1210.8 | 12.0 | "C" | 54 Light Pole | 1263.2 | 1244.4 | -18.8 | "V" |
| 5 Tree Top | 1224.6 | 1212.4 | -12.2 | "V" | 55 Tree Top | 1248.7 | 1244.1 | -4.6 | "V" |
| 6 Utility Pole | 1209.0 | 1212.3 | 3.3 | "C" | 56 Tree Top | 1252.3 | 1244.4 | -7.9 | "V" |
| 7 Tree Top | 1202.7 | 1213.2 | 10.5 | "C" | 57 Light Pole | 1263.6 | 1244.9 | -18.7 | "V" |
| 8 Utility Pole | 1215.8 | 1213.3 | -2.5 | "V" | 58 Tree Top | 1264.7 | 1245.0 | -19.7 | "V" |
| 9 Light Pole | 1224.5 | 1223.3 | -1.2 | "V" | 59 Light Pole | 1264.7 | 1245.4 | -19.3 | "V" |
| 10 Utility Pole | 1234.2 | 1227.6 | -6.6 | "V" | 60 Building | 1248.4 | 1245.5 | -2.9 | "V" |
| 11 Building | 1228.6 | 1227.8 | -0.8 | "V" | 61 Light Pole | 1266.0 | 1245.7 | -20.3 | "V" |
| 12 Tree Top | 1234.2 | 1229.2 | -5.0 | "V" | 62 Utility Pole | 1264.7 | 1246.2 | -18.5 | "V" |
| 13 Tree Top | 1243.7 | 1228.5 | -15.2 | "V" | 63 Tree Top | 1262.6 | 1247.8 | -14.8 | "V" |
| 14 Tree Top | 1240.1 | 1230.3 | -9.8 | "V" | 64 Utility Pole | 1252.3 | 1248.0 | -4.3 | "V" |
| 15 Utility Pole | 1233.3 | 1230.5 | -2.8 | "V" | 65 Utility Pole | 1260.9 | 1248.0 | -12.9 | "V" |
| 16 Tree Top | 1247.0 | 1230.5 | -16.5 | "V" | 66 Tree Top | 1275.1 | 1248.4 | -26.7 | "V" |
| 17 Utility Pole | 1235.1 | 1231.7 | -3.4 | "V" | 67 Utility Pole | 1249.6 | 1248.5 | -1.1 | "V" |
| 18 Tree Top | 1232.2 | 1232.3 | 0.1 | "C" | 68 Tree Top | 1255.2 | 1248.6 | -6.6 | "V" |
| 19 Tree Top | 1243.6 | 1232.6 | -11.0 | "V" | 69 Tree Top | 1262.2 | 1248.6 | -13.6 | "V" |
| 20 Utility Pole | 1237.0 | 1234.2 | -2.8 | "V" | 70 Utility Pole | 1251.1 | 1248.6 | -2.5 | "V" |
| 21 Tree Top | 1236.8 | 1234.5 | -2.3 | "V" | 71 Utility Pole | 1250.6 | 1248.6 | -2.0 | "V" |
| 22 Tree Top | 1254.4 | 1234.9 | -19.5 | "V" | 72 Tree Top | 1257.4 | 1248.8 | -8.6 | "V" |
| 23 Tree Top | 1247.1 | 1236.3 | -10.8 | "V" | 73 Utility Pole | 1251.8 | 1248.7 | -3.1 | "V" |
| 24 Tree Top | 1243.0 | 1237.6 | -5.4 | "V" | 74 Tree Top | 1261.4 | 1248.9 | -12.5 | "V" |
| 25 Tree Top | 1249.8 | 1238.4 | -11.4 | "V" | 75 Utility Pole | 1250.4 | 1249.1 | -1.3 | "V" |
| 26 Tree Top | 1240.7 | 1237.5 | -3.2 | "V" | 76 Tree Top | 1272.0 | 1249.7 | -22.3 | "V" |
| 27 Tree Top | 1240.7 | 1237.8 | -2.9 | "V" | 77 Utility Pole | 1250.9 | 1250.0 | -0.9 | "V" |
| 28 Tree Top | 1247.3 | 1237.7 | -0.6 | "V" | 78 Utility Pole | 1256.0 | 1250.0 | -5.6 | "V" |
| 29 Light Pole | 1246.3 | 1237.6 | -8.7 | "V" | 79 Utility Pole | 1251.3 | 1249.9 | -1.4 | "V" |
| 30 Light Pole | 1248.7 | 1238.7 | -10.0 | "V" | 80 Tree Top | 1259.5 | 1251.0 | -8.5 | "V" |
| 31 Light Pole | 1255.9 | 1239.9 | -16.0 | "V" | 81 Tree Top | 1255.6 | 1252.4 | -3.2 | "V" |
| 32 Light Pole | 1249.6 | 1240.1 | -9.5 | "V" | 82 Light Pole | 1248.4 | 1255.9 | 6.5 | "C" |
| 33 Light Pole | 1247.8 | 1240.3 | -7.5 | "V" | 83 Tree Top | 1249.8 | 1256.9 | 7.1 | "C" |
| 34 Light Pole | 1244.9 | 1241.7 | -3.2 | "V" | 84 Tree Top | 1233.3 | 1273.2 | 39.9 | "C" |
| 35 Light Pole | 1245.7 | 1241.4 | -4.3 | "V" | 85 Tree Top | 1214.0 | 1280.7 | 66.7 | "C" |
| 36 Light Pole | 1245.8 | 1241.5 | -4.3 | "V" | 86 RW Rail Road | 1180.4 | 1286.4 | 106.0 | "C" |
| 37 Light Pole | 1245.2 | 1241.5 | -3.7 | "V" | 87 Tree Top | 1225.9 | 1309.1 | 83.2 | "C" |
| 38 Light Pole | 1243.5 | 1241.2 | -2.3 | "V" | 88 Tree Top | 1248.9 | 1319.7 | 70.8 | "C" |
| 39 Light Pole | 1243.2 | 1240.8 | -2.4 | "V" | 89 Tree Top | 1247.0 | 1334.6 | 87.6 | "C" |
| 40 Light Pole | 1255.3 | 1240.9 | -14.4 | "V" | 90 Tree Top | 1258.7 | 1359.7 | 101.0 | "C" |
| 41 Light Pole | 1244.6 | 1241.4 | -3.2 | "V" | 91 Tree Top | 1270.5 | 1375.6 | 105.1 | "C" |
| 42 Tree Top | 1250.4 | 1241.5 | -8.9 | "V" | 92 Tree Top | 1274.4 | 1379.7 | 105.3 | "C" |
| 43 Light Pole | 1258.8 | 1241.8 | -17.0 | "V" | 93 Building | 1299.6 | 1396.6 | 97.0 | "C" |
| 44 Light Pole | 1259.5 | 1242.5 | -17.0 | "V" | 94 W. Van Dorn St. | 1264.2 | 1425.2 | 161.0 | "C" |
| 45 Utility Pole | 1245.7 | 1242.3 | -3.4 | "V" | 95 Tree Top | 1323.0 | 1445.8 | 122.8 | "C" |
| 46 NW 27th Street | 1246.8 | 1242.8 | -4.0 | "V" | 96 Tree Top | 1273.2 | 1474.5 | 201.3 | "C" |
| 47 Light Pole | 1248.4 | 1242.8 | -5.6 | "V" | 97 Tree Top | 1234.6 | 1484.8 | 250.2 | "C" |
| 48 Light Pole | 1262.5 | 1243.2 | -19.3 | "V" | 98 RW Rail Road | 1197.4 | 1499.3 | 301.9 | "C" |
| 49 Utility Pole | 1255.1 | 1243.3 | -9.8 | "V" | 99 Tree Top | 1251.5 | 1517.5 | 266.0 | "C" |
| 50 Light Pole | 1262.8 | 1243.9 | -18.9 | "V" | | | | | |

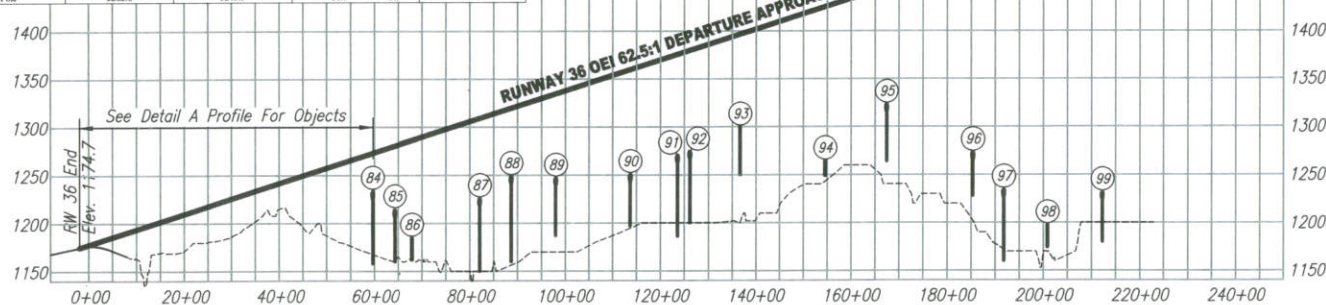

RUNWAY 36 OEI 62.5:1 DEPARTURE SURFACE

0 2000 4000 6000
FULL SIZE SCALE IN FEET (HORIZ.)

0 100 200 300
FULL SIZE SCALE IN FEET (VERT.)

| NO. | REVISIONS | DATE |
|-----|-----------|------|
| | | |

RUNWAY 36 OEI 62.5-1 DEPARTURE SURFACE

**LINCOLN AIRPORT
LINCOLN, NEBRASKA**

LINCOLN OFFICE
625 J. St., Box 80308
Lincoln, NE 68501
(402) 479-2200
www.hms.com



PROJECT: ALP
DATE: August 2007
JOB NO.: 36-7049
SHEET NO.: 23/29

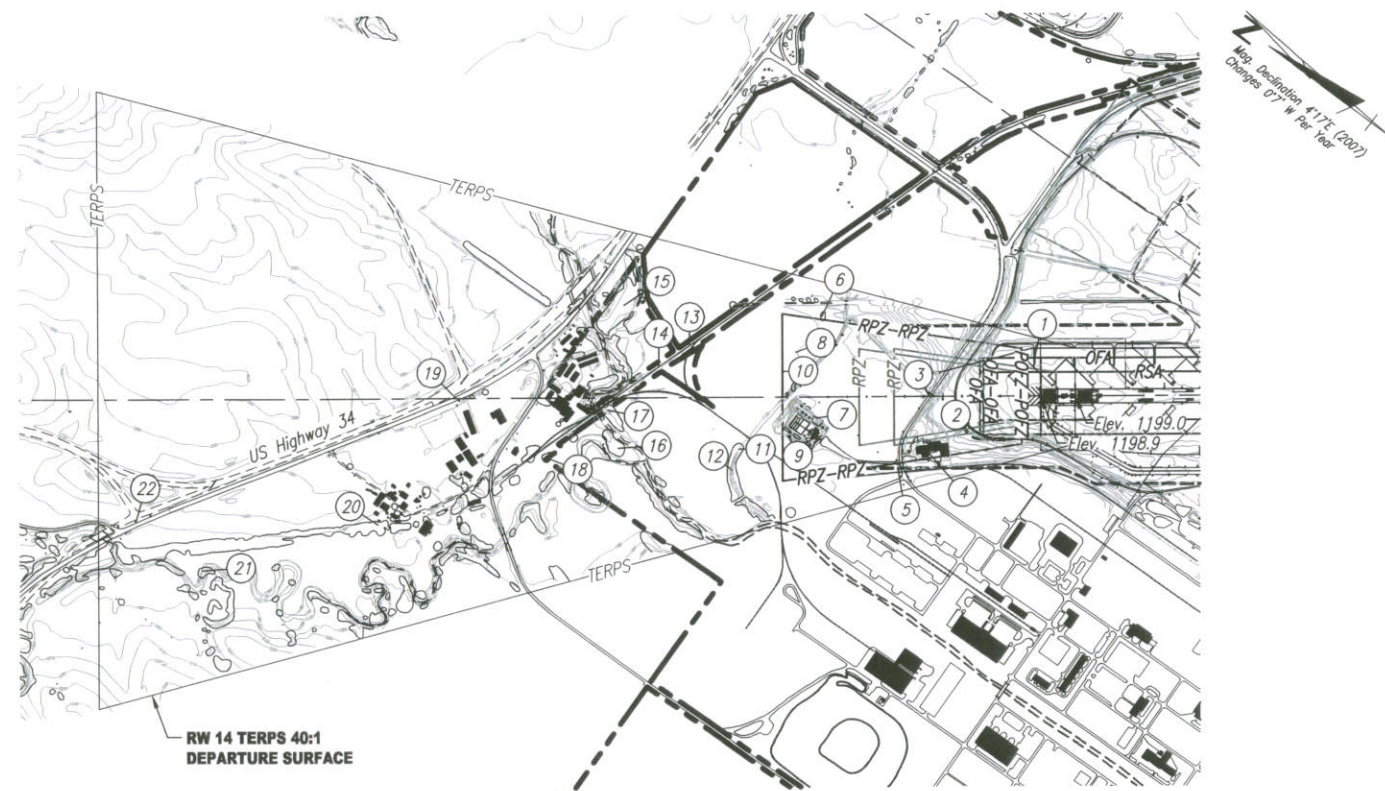

RUNWAY 14 TERPS 40:1 DEPARTURE SURFACE

| OBJECT NO./ DESCRIPTION | OBJECT ELEVATION | 40:1 TERPS DEPART. SURFACE ELEVATION | RUNWAY 14 END (40:1) | | PROPOSED DISPOSITION |
|-------------------------|------------------|--------------------------------------|----------------------|----------------|----------------------|
| | | | OBJECT PENETRATION | | |
| | | | 'C'=Clears | 'OB'=Obstructs | |
| 1 Service Road | 1205.7 | 1209.6 | 3.9 | 'C' | |
| 2 Service Road | 1194.5 | 1230.3 | 35.7 | 'C' | |
| 3 Airport Road | 1190.1 | 1237.1 | 47.0 | 'C' | - |
| 4 Building | 1205.9 | 1238.3 | 32.4 | 'C' | - |
| 5 Utility Pole | 1217.7 | 1245.5 | 27.8 | 'C' | - |
| 6 Utility Pole | 1212.4 | 1265.1 | 52.7 | 'C' | - |
| 7 Tree Top | 1225.0 | 1266.8 | 41.8 | 'C' | - |
| 8 Utility Pole | 1210.5 | 1271.8 | 61.3 | 'C' | - |
| 9 Tree Top | 1205.4 | 1273.7 | 68.3 | 'C' | - |
| 10 Utility Pole | 1216.4 | 1275.2 | 58.8 | 'C' | - |
| 11 Tree Top | 1232.9 | 1286.7 | 53.8 | 'C' | - |
| 12 Tree Top | 1234.7 | 1288.4 | 53.7 | 'C' | - |
| 13 Rail Road | 1203.2 | 1299.5 | 96.3 | 'C' | - |
| 14 Rail Road | 1203.6 | 1307.4 | 103.8 | 'C' | - |
| 15 Tree Top | 1248.1 | 1316.4 | 68.3 | 'C' | - |
| 16 Tree Top | 1237.4 | 1318.0 | 80.6 | 'C' | - |
| 17 Tree Top | 1241.1 | 1320.8 | 79.7 | 'C' | - |
| 18 Tree Top | 1256.5 | 1336.8 | 80.3 | 'C' | - |
| 19 US Hwy 34 | 1208.1 | 1360.3 | 152.2 | 'C' | - |
| 20 Tree Top | 1243.5 | 1381.0 | 137.5 | 'C' | - |
| 21 Tree Top | 1245.7 | 1427.0 | 181.3 | 'C' | - |
| 22 Light Pole | 1237.1 | 1444.1 | 207.0 | 'C' | - |

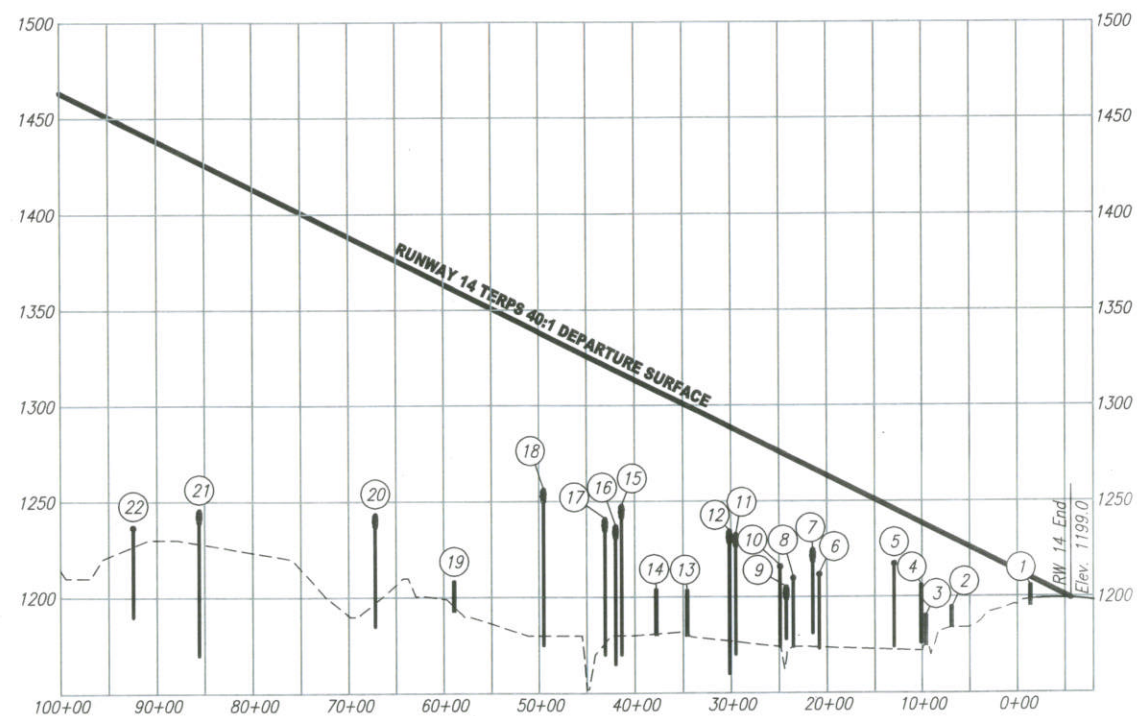

RUNWAY 14 TERPS 40:1 DEPARTURE SURFACE

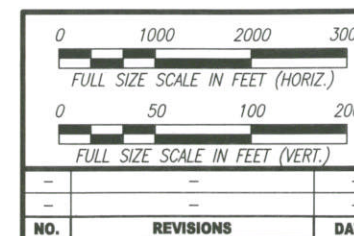

RUNWAY 14 TERPS 40-1 DEPARTURE SURFACE

**LINCOLN AIRPORT
LINCOLN, NEBRASKA**

LINCOLN OFFICE
825 J St., Box 80368
Lincoln, NE 68501
(402) 479-2200
www.hws.com



PROJECT: ALP
DATE: August 2007
JOB NO.: 36-7049
SHEET NO.: 24/29

F:\Transportation\367049\Sheet24.dwg

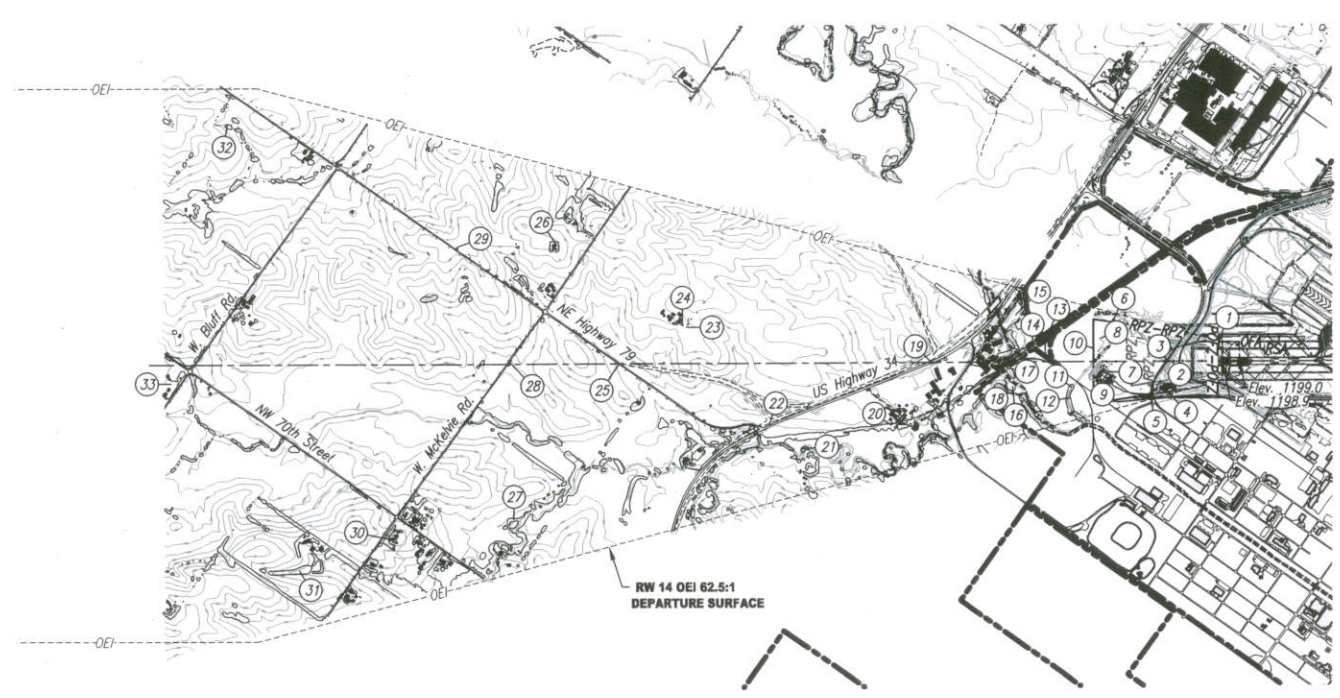

RUNWAY 14 OEI 62.5:1 DEPARTURE SURFACE

| 62.5:1 OEI DEPARTURE SURFACE OBSTRUCTION TABLE | | | RUNWAY 14 END (62.5:1) | | |
|--|------------------|--------------------------------------|------------------------|----------------|-----------------------------|
| OBJECT NO./ DESCRIPTION | OBJECT ELEVATION | 62.5:1 OEI DEPART. SURFACE ELEVATION | OBJECT PENETRATION | | PROPOSED DISPOSITION |
| | | | 'C'=Clears | 'OB'=Obstructs | |
| 1 Service Road | 1205.7 | 1199.5 | -6.2 | 'OB' | Restricted Int. Service Rd. |
| 2 Service Road | 1194.5 | 1212.8 | 18.2 | 'C' | - |
| 3 Airport Road | 1190.1 | 1217.1 | 27.1 | 'C' | - |
| 4 Building | 1205.9 | 1217.9 | 12.0 | 'C' | - |
| 5 Utility Pole | 1217.7 | 1222.5 | 4.8 | 'C' | - |
| 6 Utility Pole | 1212.4 | 1235.0 | 22.6 | 'C' | - |
| 7 Tree Top | 1225.0 | 1236.1 | 11.1 | 'C' | - |
| 8 Utility Pole | 1210.5 | 1239.4 | 28.9 | 'C' | - |
| 9 Tree Top | 1205.4 | 1240.5 | 35.1 | 'C' | - |
| 10 Utility Pole | 1216.4 | 1241.5 | 25.1 | 'C' | - |
| 11 Tree Top | 1232.9 | 1248.9 | 16.0 | 'C' | - |
| 12 Tree Top | 1234.7 | 1250.0 | 15.3 | 'C' | - |
| 13 BN Rail Road | 1203.2 | 1257.1 | 53.9 | 'C' | - |
| 14 BN Rail Road | 1203.6 | 1262.1 | 58.5 | 'C' | - |
| 15 Tree Top | 1248.1 | 1267.9 | 19.8 | 'C' | - |
| 16 Tree Top | 1237.4 | 1268.9 | 31.5 | 'C' | - |
| 17 Tree Top | 1241.1 | 1270.7 | 29.6 | 'C' | - |
| 18 Tree Top | 1256.5 | 1280.9 | 24.4 | 'C' | - |
| 19 US Hwy 34 | 1208.1 | 1296.0 | 87.9 | 'C' | - |
| 20 Tree Top | 1243.5 | 1309.2 | 65.7 | 'C' | - |
| 21 Tree Top | 1245.7 | 1338.7 | 93.0 | 'C' | - |
| 22 Light Pole | 1237.1 | 1349.7 | 112.6 | 'C' | - |
| 23 Utility Pole | 1282.7 | 1377.2 | 94.5 | 'C' | - |
| 24 Tree Top | 1287.4 | 1378.8 | 91.4 | 'C' | - |
| 25 NE Highway 79 | 1226.6 | 1399.9 | 173.3 | 'C' | - |
| 26 Tree Top | 1340.4 | 1420.7 | 80.3 | 'C' | - |
| 27 Tree Top | 1267.1 | 1435.3 | 168.2 | 'C' | - |
| 28 Tree Top | 1241.9 | 1436.5 | 194.6 | 'C' | - |
| 29 Utility Pole | 1349.1 | 1453.7 | 104.6 | 'C' | - |
| 30 Tree Top | 1355.4 | 1476.5 | 121.1 | 'C' | - |
| 31 Tree Top | 1357.4 | 1507.2 | 149.8 | 'C' | - |
| 32 Tree Top | 1330.3 | 1530.7 | 200.4 | 'C' | - |
| 33 Tree Top | 1311.6 | 1549.8 | 238.2 | 'C' | - |

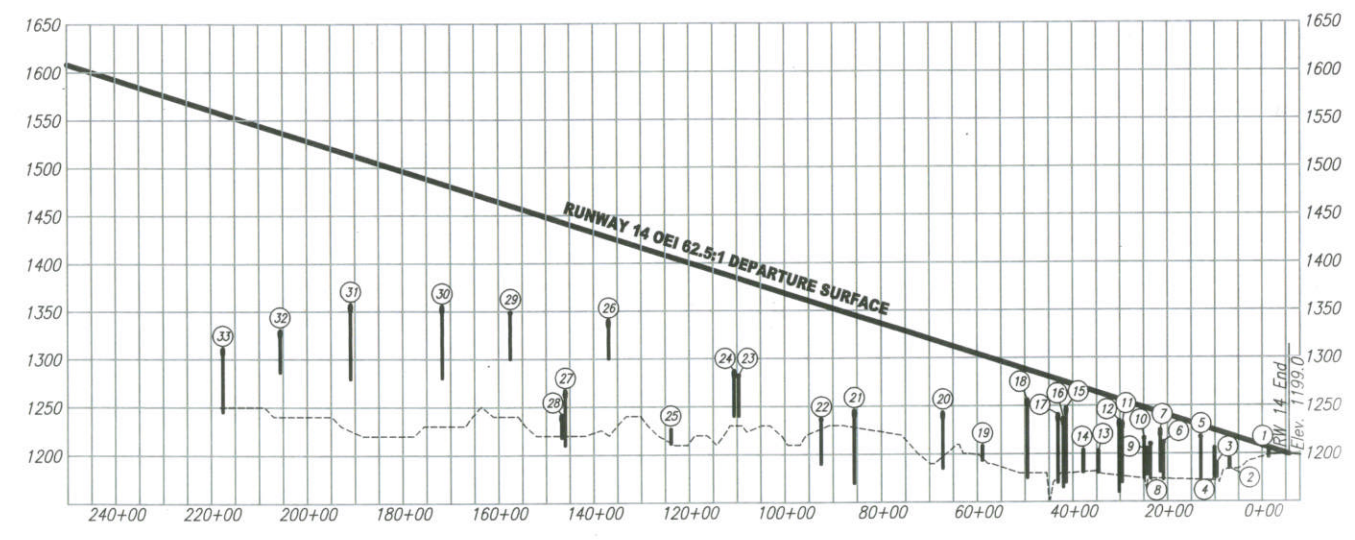

RUNWAY 14 OEI 62.5:1 DEPARTURE SURFACE

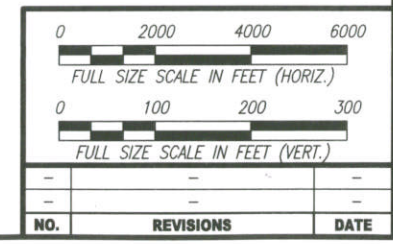

RUNWAY 14 OEI 62.5-1 DEPARTURE SURFACE

**LINCOLN AIRPORT
LINCOLN, NEBRASKA**

LINCOLN OFFICE
825 N. St., Box 80388
Lincoln, NE 68501
(402) 479-2200
www.hws.com



PROJECT: ALP
DATE: August 2007
JOB NO.: 36-7049
SHEET NO.: 25/29

F:\Transportation\367049\Sheet\Sheet25.dwg

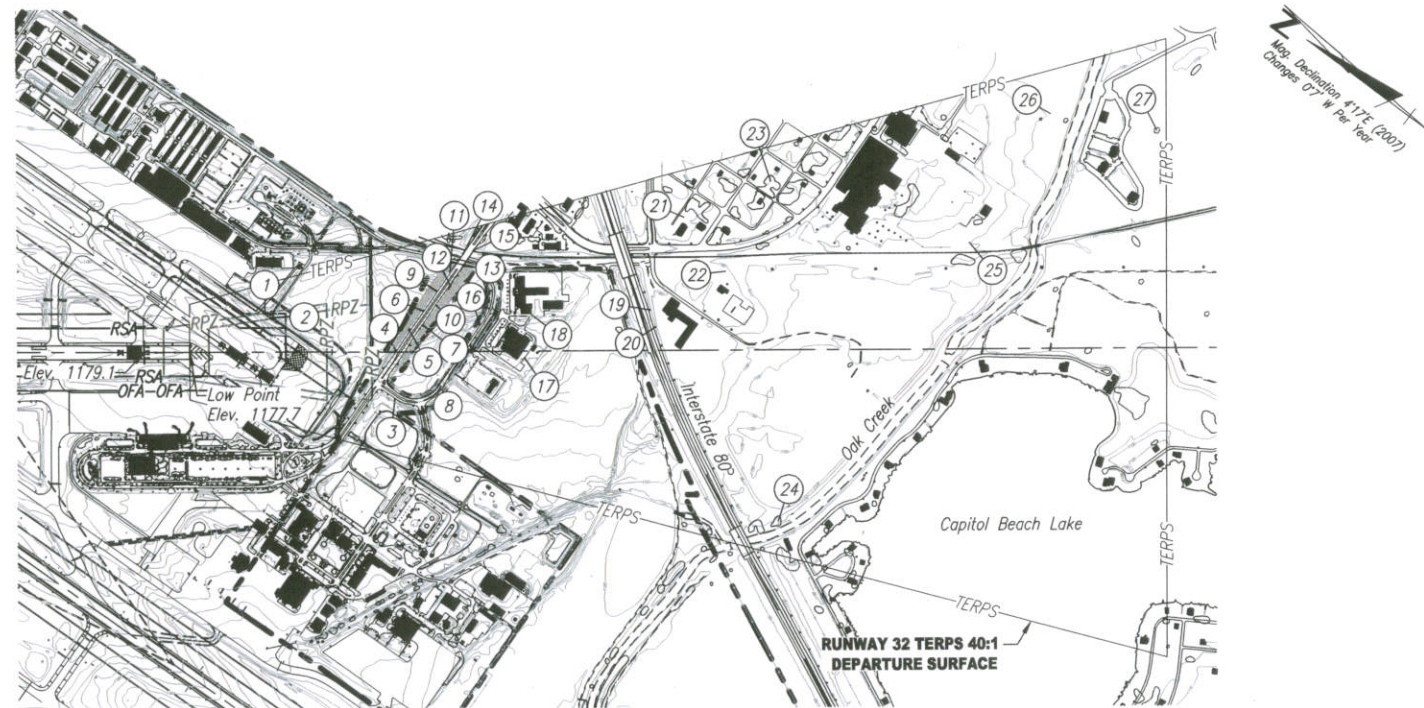

RUNWAY 32 TERPS 40:1 DEPARTURE SURFACE

| 40:1 TERPS DEPARTURE SURFACE OBSTRUCTION TABLE | | | RUNWAY 32 END (40:1) | | PROPOSED DISPOSITION |
|--|------------------|--------------------------------------|----------------------|----------------|----------------------|
| OBJECT NO./ DESCRIPTION | OBJECT ELEVATION | 40:1 TERPS DEPART. SURFACE ELEVATION | 'C'=Clears | 'OB'=Obstructs | |
| 1 | Service Road | 1187.5 | 1197.2 | 9.8 | 'C' |
| 2 | Service Road | 1187.0 | 1198.9 | 11.9 | 'C' |
| 3 | Light Pole | 1194.1 | 1231.1 | 37.0 | 'C' |
| 4 | Light Pole | 1215.7 | 1231.3 | 15.6 | 'C' |
| 5 | Light Pole | 1223.7 | 1234.9 | 11.2 | 'C' |
| 6 | Light Pole | 1234.5 | 1238.5 | 4.0 | 'C' |
| 7 | Light Pole | 1226.1 | 1238.5 | 12.4 | 'C' |
| 8 | Light Pole | 1194.8 | 1239.0 | 44.2 | 'C' |
| 9 | Light Pole | 1245.4 | 1242.1 | -3.3 | 'OB' |
| 10 | Light Pole | 1237.4 | 1242.1 | 4.7 | 'C' |
| 11 | Light Pole | 1254.3 | 1245.6 | -8.7 | 'OB' |
| 12 | Light Pole | 1247.2 | 1245.7 | -1.5 | 'OB' |
| 13 | Light Pole | 1266.0 | 1249.1 | -16.9 | 'OB' |
| 14 | Light Pole | 1264.6 | 1249.1 | -15.5 | 'OB' |
| 15 | Light Pole | 1285.1 | 1252.0 | -33.1 | 'OB' |
| 16 | Light Pole | 1207.0 | 1253.4 | 46.4 | 'C' |
| 17 | Light Pole | 1212.4 | 1265.0 | 52.6 | 'C' |
| 18 | Building | 1213.5 | 1265.5 | 52.0 | 'C' |
| 19 | Light Pole | 1246.9 | 1297.8 | 50.9 | 'C' |
| 20 | Light Pole | 1239.4 | 1299.3 | 59.9 | 'C' |
| 21 | Utility Pole | 1273.0 | 1306.8 | 33.8 | 'C' |
| 22 | Utility Pole | 1293.5 | 1317.6 | 24.1 | 'C' |
| 23 | Tree Top | 1268.8 | 1329.4 | 60.6 | 'C' |
| 24 | Tree Top | 1204.7 | 1331.0 | 126.3 | 'C' |
| 25 | Utility Pole | 1239.4 | 1381.0 | 141.6 | 'C' |
| 26 | Utility Pole | 1225.1 | 1402.6 | 177.5 | 'C' |
| 27 | Tree Top | 1226.6 | 1430.3 | 203.7 | 'C' |

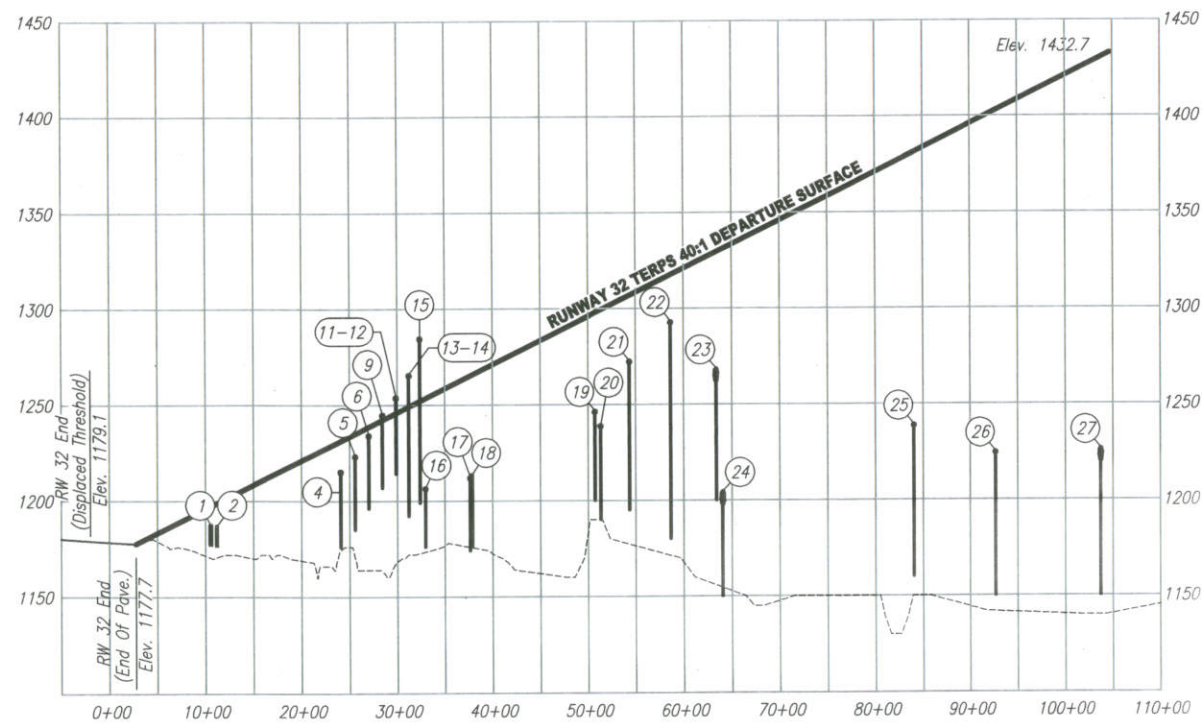

NOTE: All Objects in Plan View Are Not Shown In Profile View. See Table On This Sheet.

RUNWAY 32 TERPS 40:1 DEPARTURE SURFACE

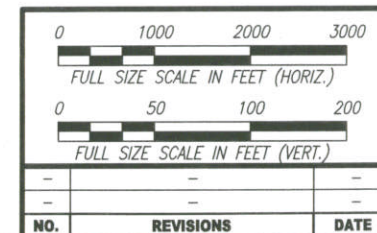

RUNWAY 32 TERPS 40-1 DEPARTURE SURFACE

**LINCOLN AIRPORT
LINCOLN, NEBRASKA**

LINCOLN OFFICE
825 J St., Box 80388
Lincoln, NE 68501
(402) 479-2200
www.hms.com



| | | |
|-----------|-------------|------|
| PROJECT | ALP | |
| DATE | August 2007 | |
| JOB NO. | 36-7049 | |
| SHEET NO. | 26 | |
| | 29 | |
| NO. | REVISIONS | DATE |
| - | - | - |
| - | - | - |

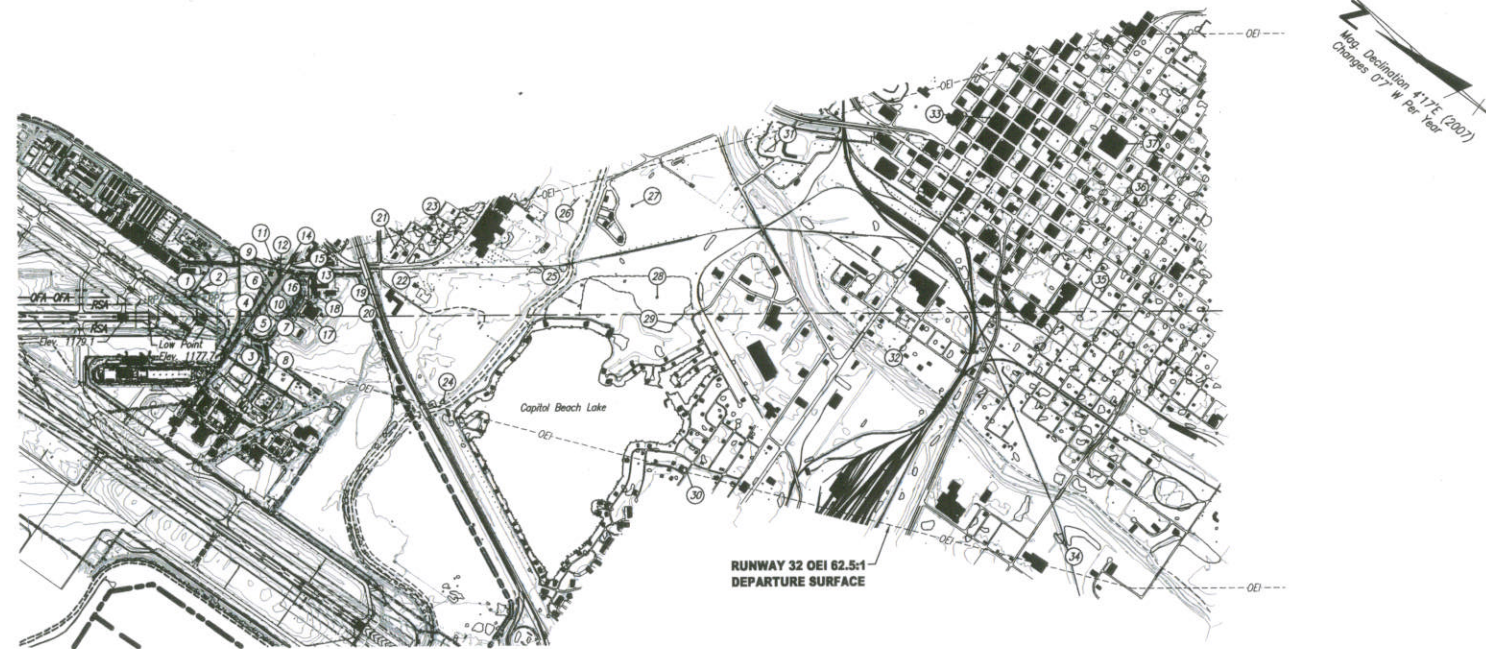

RUNWAY 32 OEI 62.5:1 DEPARTURE SURFACE

| OBJECT NO./ DESCRIPTION | OBJECT ELEVATION | 62.5:1 OEI DEPART. SURFACE ELEVATION | RUNWAY 32 END (62.5:1) | | PROPOSED DISPOSITION |
|----------------------------|------------------|---|------------------------|----------------|-------------------------|
| | | | OBJECT PENETRATION | | |
| | | | 'C'=Clears | 'OB'=Obstructs | |
| 1 Service Road | 1187.5 | 1190.2 | 2.8 | 'C' | - |
| 2 Service Road | 1187.0 | 1191.2 | 4.3 | 'C' | - |
| 3 Light Pole | 1194.1 | 1211.9 | 17.8 | 'C' | - |
| 4 Light Pole | 1215.7 | 1212.0 | -3.7 | 'OB' | To Remain |
| 5 Light Pole | 1223.7 | 1214.3 | -9.4 | 'OB' | To Remain |
| 6 Light Pole | 1234.5 | 1216.6 | -17.9 | 'OB' | To Remain |
| 7 Light Pole | 1226.1 | 1216.6 | -9.5 | 'OB' | To Remain |
| 8 Light Pole | 1194.8 | 1216.9 | 22.1 | 'C' | - |
| 9 Light Pole | 1245.4 | 1218.9 | -26.5 | 'OB' | To Remain |
| 10 Light Pole | 1237.4 | 1218.9 | -18.5 | 'OB' | To Remain |
| 11 Light Pole | 1254.3 | 1221.2 | -33.1 | 'OB' | To Remain |
| 12 Light Pole | 1247.2 | 1221.2 | -26.0 | 'OB' | To Remain |
| 13 Light Pole | 1266.0 | 1223.4 | -42.6 | 'OB' | To Remain |
| 14 Light Pole | 1264.6 | 1223.4 | -41.2 | 'OB' | To Remain |
| 15 Light Pole | 1285.1 | 1225.2 | -59.9 | 'OB' | To Remain |
| 16 Light Pole | 1207.0 | 1226.1 | 19.1 | 'C' | - |
| 17 Light Pole | 1212.4 | 1233.6 | 21.2 | 'C' | - |
| 18 Building | 1213.5 | 1233.9 | 20.4 | 'C' | - |
| 19 Light Pole | 1246.9 | 1254.6 | 7.7 | 'C' | - |
| 20 Light Pole | 1239.4 | 1255.5 | 16.1 | 'C' | - |
| 21 Utility Pole | 1273.0 | 1260.3 | -12.7 | 'OB' | To Remain |
| 22 Utility Pole | 1293.5 | 1267.2 | -26.3 | 'OB' | To Remain |
| 23 Tree Top | 1268.8 | 1274.8 | 6.0 | 'C' | - |
| 24 Tree Top | 1204.7 | 1275.8 | 71.1 | 'C' | - |
| 25 Utility Pole | 1239.4 | 1307.8 | 68.4 | 'C' | - |
| 26 Utility Pole | 1225.1 | 1321.6 | 96.5 | 'C' | - |
| 27 Tree Top | 1226.6 | 1339.3 | 112.7 | 'C' | - |
| 28 Tree Top | 1193.9 | 1347.6 | 153.7 | 'C' | - |
| 29 Tree Top | 1209.1 | 1353.6 | 144.5 | 'C' | - |
| 30 Tree Top | 1247.9 | 1356.8 | 108.9 | 'C' | - |
| 31 Light Pole | 1208.1 | 1383.7 | 175.6 | 'C' | - |
| 32 Tree Top | 1229.4 | 1431.6 | 202.2 | 'C' | - |
| 33 Building | 1347.2 | 1462.0 | 114.8 | 'C' | - |
| 34 Tree Top | 1238.3 | 1480.4 | 242.1 | 'C' | - |
| 35 Tree Top | 1253.3 | 1488.9 | 235.6 | 'C' | - |
| 36 Tree Top | 1266.1 | 1500.5 | 234.4 | 'C' | - |
| 37 Building | 1578.1 | 1499.9 | -78.2 | 'OB' | To Remain |

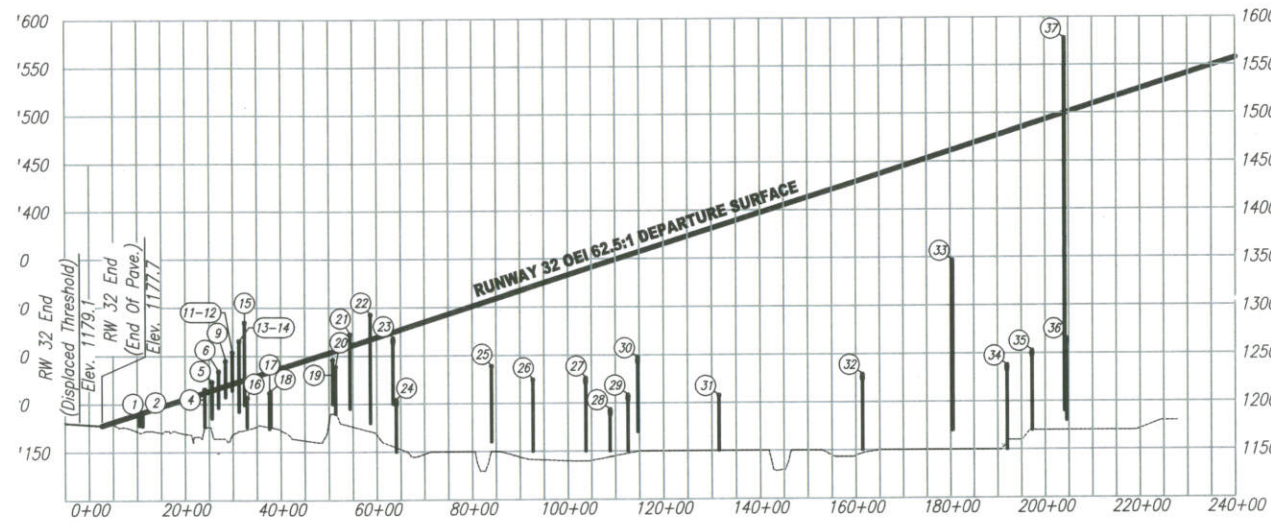

RUNWAY 32 OEI 62.5:1 DEPARTURE SURFACE

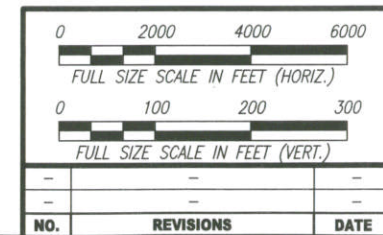

**RUNWAY 32 OEI 62.5-1
DEPARTURE SURFACE**

**LINCOLN AIRPORT
LINCOLN, NEBRASKA**

LINCOLN OFFICE
625 J. St., Box 80358
Lincoln, NE 68501
(402) 479-2200
www.hms.com



PROJECT: ALP
DATE: August 2007
JOB NO.: 36-7049
SHEET NO.: 27/29

Mag. Declination 4°17'E (2007)
Changes 0'7" W Per Year

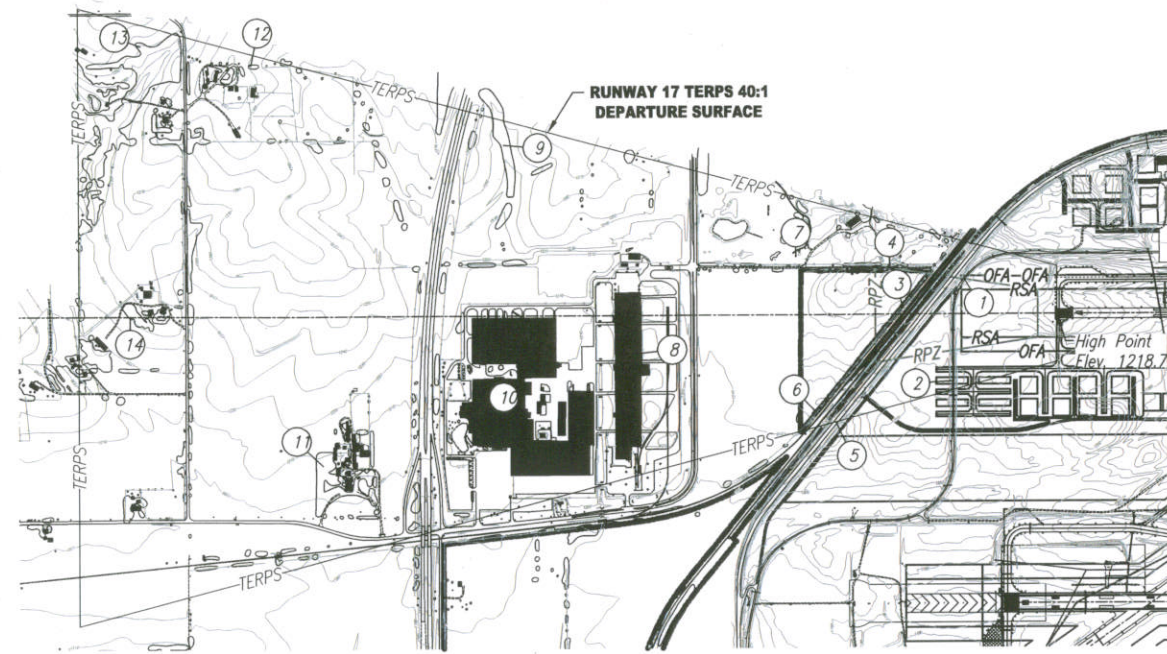

RUNWAY 17 TERPS 40:1 DEPARTURE SURFACE

| 40:1 TERPS DEPARTURE SURFACE OBSTRUCTION TABLE | | | RUNWAY 17 END (40:1) | | |
|--|------------------|---|----------------------|----------------|-------------------------|
| OBJECT NO./ DESCRIPTION | OBJECT ELEVATION | 40:1 TERPS DEPART. SURFACE ELEVATION | OBJECT PENETRATION | | PROPOSED DISPOSITION |
| | | | 'C'=Clears | 'OB'=Obstructs | |
| 1 Service Road | 1228.7 | 1242.8 | 14.1 | 'C' | |
| 2 Ultimate Building | 1230.0 (Est.) | 1245.8 | 15.8 | 'C' | |
| 3 Tree Top | 1242.5 | 1259.1 | 16.6 | 'C' | |
| 4 Tree Top | 1259.3 | 1262.4 | 3.1 | 'C' | |
| 5 North Park Road | 1224.6 | 1276.4 | 51.8 | 'C' | |
| 6 Tree Top | 1248.7 | 1281.5 | 32.8 | 'C' | |
| 7 Tree Top | 1241.2 | 1286.7 | 45.5 | 'C' | |
| 8 Building | 1257.1 | 1330.2 | 73.1 | 'C' | |
| 9 Tree Top | 1294.8 | 1362.7 | 67.9 | 'C' | |
| 10 Building | 1272.2 | 1370.3 | 98.1 | 'C' | |
| 11 Tree Top | 1266.6 | 1410.2 | 143.6 | 'C' | |
| 12 Tree Top | 1347.5 | 1428.7 | 81.2 | 'C' | |
| 13 Tree Top | 1345.4 | 1457.4 | 112.0 | 'C' | |
| 14 Tree Top | 1294.1 | 1460.4 | 166.3 | 'C' | |

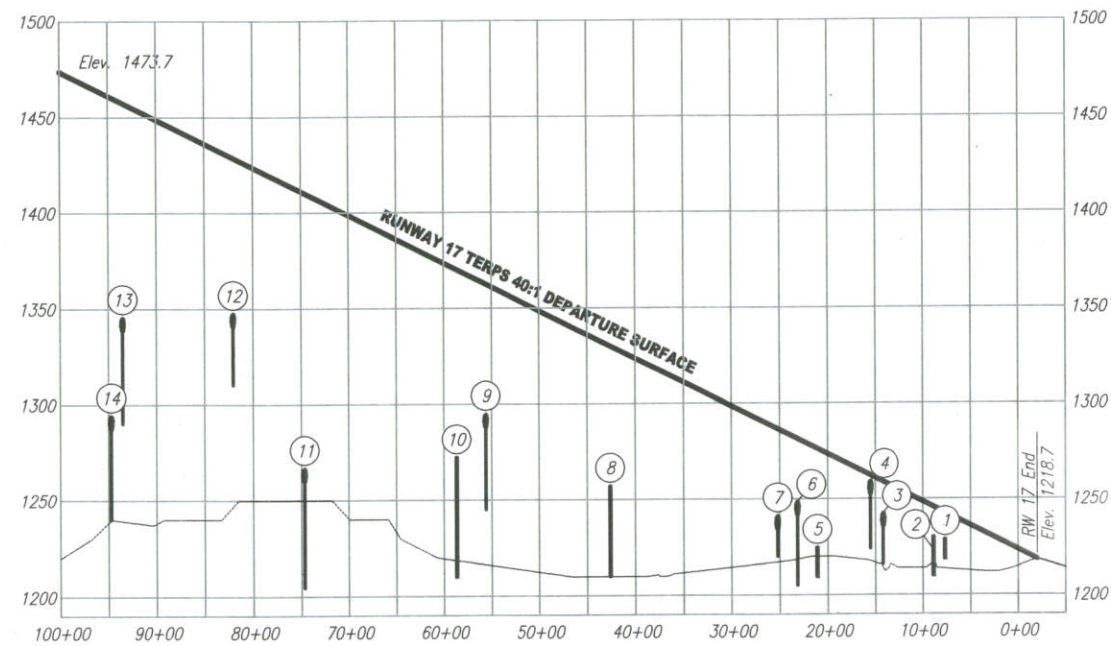

RUNWAY 17 TERPS 40:1 DEPARTURE SURFACE

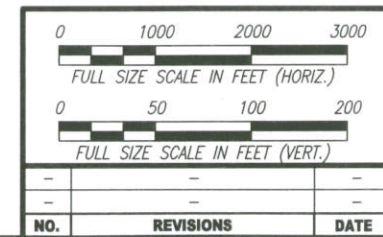

**RUNWAY 17 TERPS 40-1
DEPARTURE SURFACE**

**LINCOLN AIRPORT
LINCOLN, NEBRASKA**

LINCOLN OFFICE
625 J St., Box 80358
Lincoln, NE 68501
(402) 479-2200
www.hms.com



PROJECT
ALP
DATE
August 2007
JOB NO.
36-7049
SHEET NO.
28
29

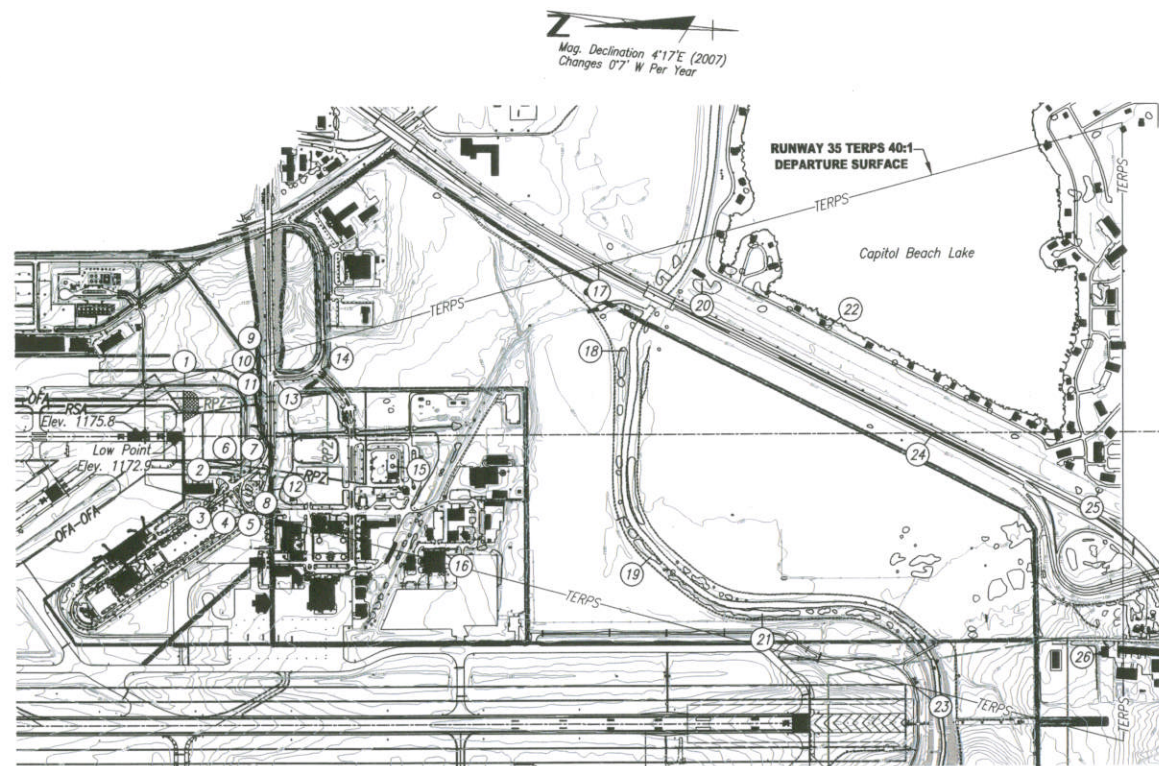

RUNWAY 35 TERPS 40:1 DEPARTURE SURFACE

| OBJECT NO./ DESCRIPTION | OBJECT ELEVATION | 40:1 TERPS DEPART. SURFACE ELEVATION | RUNWAY 35 END (40:1) | | PROPOSED DISPOSITION |
|----------------------------|------------------|---|----------------------|----------------|-------------------------------|
| | | | OBJECT PENETRATION | | |
| | | | 'C'=Clears | 'OB'=Obstructs | |
| 1 Terminal Loop Road | 1185.3 | 1177.7 | -7.6 | 'OB' | Restricted Interior Serv. Rd. |
| 2 Building | 1191.9 | 1177.2 | -14.7 | 'OB' | To Remain |
| 3 Tree Top | 1202.8 | 1183.0 | -19.8 | 'OB' | Remove |
| 4 Light Pole | 1197.2 | 1183.3 | -13.9 | 'OB' | To Remain |
| 5 Tree Top | 1200.3 | 1186.8 | -13.5 | 'OB' | Remove |
| 6 Terminal Loop Road | 1175.5 | 1187.4 | 11.9 | 'C' | - |
| 7 Light Pole | 1192.9 | 1190.1 | -2.8 | 'OB' | To Remain |
| 8 Tree Top | 1202.6 | 1189.0 | -13.6 | 'OB' | Remove |
| 9 Light Pole | 1204.9 | 1200.6 | -4.3 | 'OB' | To Remain |
| 10 Light Pole | 1204.4 | 1194.5 | -9.9 | 'OB' | To Remain |
| 11 Light Pole | 1201.1 | 1194.5 | -6.6 | 'OB' | To Remain |
| 12 Light Pole | 1193.8 | 1194.9 | 1.1 | 'C' | - |
| 13 Light Pole | 1204.4 | 1197.5 | -6.9 | 'OB' | To Remain |
| 14 Light Pole | 1194.8 | 1209.1 | 14.3 | 'C' | - |
| 15 Storage Tank | 1191.9 | 1227.3 | 35.4 | 'C' | - |
| 16 Tree Top | 1188.2 | 1239.6 | 51.4 | 'C' | - |
| 17 Interstate 80 | 1181.9 | 1296.6 | 114.7 | 'C' | - |
| 18 Tree Top | 1186.7 | 1288.1 | 101.4 | 'C' | - |
| 19 Tree Top | 1186.2 | 1294.8 | 108.6 | 'C' | - |
| 20 Tree Top | 1227.0 | 1308.3 | 81.3 | 'C' | - |
| 21 Tree Top | 1195.8 | 1323.5 | 127.7 | 'C' | - |
| 22 Tree Top | 1196.2 | 1341.1 | 144.9 | 'C' | - |
| 23 South Service Road | 1171.4 | 1378.3 | 206.9 | 'C' | - |
| 24 Interstate 80 | 1172.9 | 1368.3 | 195.4 | 'C' | - |
| 25 Tree Top | 1239.7 | 1411.7 | 172.0 | 'C' | - |
| 26 Building | 1217.0 | 1413.1 | 196.1 | 'C' | - |

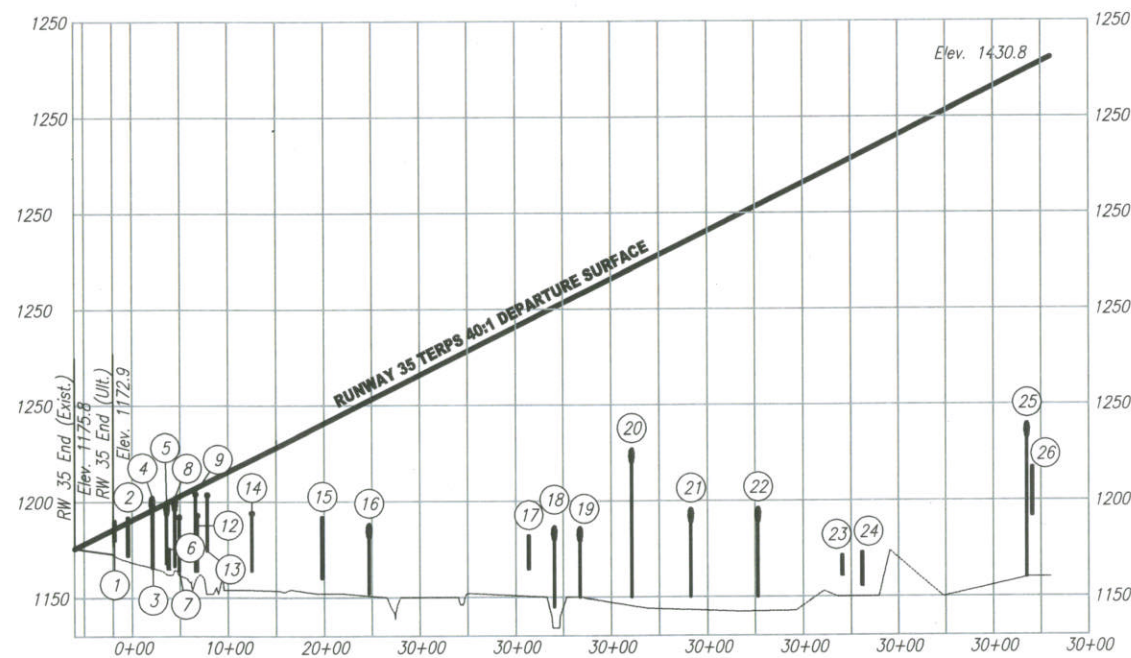

RUNWAY 35 TERPS 40:1 DEPARTURE SURFACE

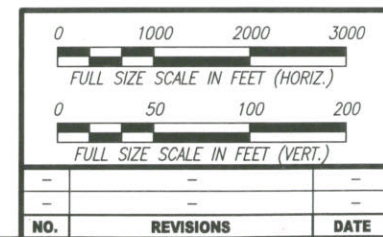

**RUNWAY 35 TERPS 40-1
DEPARTURE SURFACE**

**LINCOLN AIRPORT
LINCOLN, NEBRASKA**

LINCOLN OFFICE
825 J St., Box 80358
Lincoln, NE 68501
(402) 479-2200
www.hms.com



PROJECT
ALP
DATE
August 2007
JOB NO.
36-7049
SHEET NO.
29
29



www.coffmanassociates.com

